



Sommaire

Summary - Zusammenfassung - Resumen - Sommario

FR	EN	DE	SP	IT	
Légendes	Legend	Zeichenerklärung	Nota	Leggenda	2
Affectations par Marques	Vehicule application	Zuordnung nach Marke und Fahrzeuge	Aplicacion por marca y vehiculo	Applicazione per marca e veicolo	3
Références d'origine Etrier	OEM	OE Nummern	Codigos originales	Codici originali	320
Visuel Etriers	Visual	Visuell	Visual	Visivo	346
MOTIFS DE REFUS DE LA DECONSIGNE	REFUSAL REASONS OF OLD CORE	ABLEHNUNGSGRÜNDE DES ALTTTEILS	MOTIVOS DE RECHAZO DEL CASCO	MOTIVI DI RIFIUTO DELLA CARCASSA	607



Affectations par Marques

Vehicule application - Zuordnung nach Marke und Fahrzeuge - Applicazione per marca e veicolo - Aplicacion por marca y vehiculo

	9	10	11	12	13	14		
	BMW							
	3 (E92)							
325i		09.2006-12.2013	ATE	1 57 24			X224699	X224700
		09.2006-12.2013	ATE	1 57 24/Ø300			X224805	X224806
		09.2006-12.2013	ATE	1 57 24/Ø312			X224753	X224754
		09.2006-12.2013	BREMBO	6 3/32/3 24			X284159	X284160
		09.2006-12.2013	ATE	1 42 20/Ø300			X225367	X225368
325i xDrive		09.2008-12.2013	ATE	1 57 24			X224699	X224700
		09.2008-12.2013	ATE	1 42 20/Ø300			X225367	X225368

	FR	EN	DE
1	Modèle du véhicule	Model of the vehicle	Fahrzeugmodell
2	Type du véhicule	Type of vehicle	Fahrzeugtyp
3	Marque du véhicule	Vehicles brand	Fahrzeugmarke
4	Date de début de fabrication	Start of production	Baujahr (Produktionsbeginn)
5	Date de fin de fabrication	End of production	Baujahr (Produktionsende)
6	Remarques éventuelles	Comments	eventuelle Anmerkungen
7	Référence étrier de frein Gauche	Left brake caliper part number	Teilenr Bremssattel Links
8	Référence étrier de frein Droite	Right brake caliper part number	Teilenr Bremssattel Rechts
9	Position avant/arrière	Front/rear position	vordere/hintere Position
10	Fabricant de l'étrier de frein	Brake caliper manufacturer	Hersteller des Bremssattels
11	Nombre de pistons	Number of pistons	Anzahl der Kolben
12	Diamètre des pistons	Diameter of the pistons	Durchmesser der Kolben
13	Epaisseur, diamètre, nombre de trous du disque	Thickness, diameter, number of holes in the disc	Dicke, Durchmesser, Anzahl der Löcher in der Scheibe
14	Disque ventilé/plein	Ventilated/full brake disc	Gelüftete/volle Bremsscheibe

	ES	IT
1	Modelo del vehículo	Modello del veicolo
2	Tipo del vehículo	Tipo del veicolo
3	Marca del vehículo	Marca del veicolo
4	Fecha del principio de fabricación	Data d'inizio di fabbricazione
5	Fecha del fin de fabricación	Data di fine di fabbricazione
6	Noticias eventuales	Eventuali osservazioni
7	Referencia pinza de freno izquierda	Codice pinza di freno sinistro
8	Referencia pinza de freno derecha	Codice pinza di freno destro
9	Posición delantera/trasera	Posizione anteriore/posteriore
10	Fabricante de la pinza de freno	Fabbricante de la pinza di freno
11	Cantidad de pistones	Numero di pistoni
12	Diámetro de los pistones	Diametro dei pistoni
13	Espesor, diámetro, número de agujeros en el disco	Spessore, diametro, numero di fori nel disco
14	Disco ventilado/lleño	Disco di freno ventilato/pieno

Affectations par Marques

Vehicule application - Zuordnung nach Marke und Fahrzeuge - Applicazione per marca e veicolo - Aplicacion por marca y vehiculo



AC



COBRA

Tout / All / Alle / Tutti / Todos		06.1963	12.1965	GIRL-TRW	3	38/54			CSX2165->	X374643	X374644
		01.1962	12.1963	GIRL-TRW	3	30/43			CSX2000->CSX2124	X375211	X375212
		01.1962	12.1963	GIRL-TRW	3	30/43			CSX2125->CSX2164	X375211	X375212
		06.1963	12.1965	GIRL-TRW	3	30/43			CSX2125->CSX2164	X375373	X375374

COBRA IV

4.9 Roadster		09.1997	08.1999	GIRL-TRW	2	54				X374613	X374614
--------------	--	---------	---------	----------	---	----	--	--	--	---------	---------



ALFA ROMEO



6 (119)

Tout / All / Alle / Tutti / Todos		04.1979	12.1986	ATE	4	40	22			X224319	X224320
		04.1979	12.1986	ATE	2	42	11			X225143	X225144

33 (905)

1.2 (905.A)		06.1983	12.1989	BENDIX	1	48	11			X254021	X254022
		06.1983	12.1989	BENDIX	1	48	12,7			X254127	X254128
1.3		05.1983	12.1989	BENDIX	1	48	11			X254021	X254022
		05.1983	12.1989	BENDIX	1	48	12,7			X254127	X254128
1.5		05.1983	12.1989	BENDIX	1	48	11			X254021	X254022
		05.1983	12.1989	BENDIX	1	48	12,7			X254127	X254128
1.5 4x4 (905.A2/.A2A/.A2F/.A2M/.A2T)		11.1983	12.1989	BENDIX	1	48	11			X254021	X254022
		11.1983	12.1989	BENDIX	1	48	12,7			X254127	X254128
1.7 QV (905.A3)		03.1988	12.1989	ATE	1	48	22			X224231	X224232

33 (905A)

1.4		01.1984	12.1988	BENDIX	1	48	11			X254021	X254022
		01.1984	12.1988	BENDIX	1	48	12,7			X254127	X254128
1.5		09.1984	12.1989	BENDIX	1	48	11			X254021	X254022
		05.1985	12.1989	BENDIX	1	48	12,7			X254127	X254128
1.5 4x4 (905.A2B/.A2C/.A2U)		09.1984	12.1986	BENDIX	1	48	11			X254021	X254022
		09.1984	12.1986	BENDIX	1	48	12,7			X254127	X254128
1.7 i.e. 4x4		09.1988	12.1989	ATE	1	48	22			X224231	X224232

33 (907A)

1.4		06.1991	09.1994	GIRL-TRW	1	48	12,7			X374269	X374270
1.5		01.1990	09.1994	GIRL-TRW	1	48	12,7			X374269	X374270
1.7 16V (907.A1B)		01.1990	03.1992	GIRL-TRW	1	48	12,7			X374269	X374270
1.7 16V (907.A1C)		01.1990	09.1994	ATE	1	48	22			X224231	X224232
		01.1990	09.1994	GIRL-TRW	1	48	12,7			X374269	X374270
1.7 4x4		01.1990	09.1994	ATE	1	48	22			X224231	X224232
		01.1990	09.1994	GIRL-TRW	1	48	12,7			X374269	X374270
1.7 i.e. (907.A1A)		01.1990	03.1992	GIRL-TRW	1	48	12,7			X374269	X374270
Tout / All / Alle / Tutti / Todos		01.1990	06.1991	GIRL-TRW	1	36	11		2WD	X375059	X375060
		01.1990	09.1994	GIRL-TRW	1	36	11		4WD	X375061	X375062

X=1 : SNRA - X=2 : EAI - X=3 : SERA - X=4 : SEEAC - X=5 : NEOTO - X=6 : STARTCAR

Affectations par Marques

Vehicule application - Zuordnung nach Marke und Fahrzeuge - Applicazione per marca e veicolo - Aplicacion por marca y vehiculo



ALFA ROMEO



33 (907B)

1.4 i.e.		06.1991	09.1994	GIRL-TRW	1	48	12,7		X374269	X374270	
1.4 i.e. 4x4		07.1990	09.1994	GIRL-TRW	1	48	12,7		X374269	X374270	
1.5 i.e		01.1990	09.1994	GIRL-TRW	1	48	12,7		X374269	X374270	
1.7		01.1990	09.1994	GIRL-TRW	1	48	12,7		X374269	X374270	
1.7 4x4 (907.B1H/.B1E)		01.1990	03.1992	ATE	1	48	22		X224231	X224232	
		01.1990	03.1992	GIRL-TRW	1	48	12,7		X374269	X374270	
Tout / All / Alle / Tutti / Todos		01.1990	06.1991	GIRL-TRW	1	36	11		2WD	X375059	X375060
		01.1990	09.1994	GIRL-TRW	1	36	11		4WD	X375061	X375062

75 (162B)

Tout / All / Alle / Tutti / Todos		05.1985	09.1992	ATE	2	48	12,7		X224089	X224090
		05.1985	09.1992	BREMBO	2	48	22		X284005	X284006
		01.1992		GIRL-TRW	1	54	22		X374165	X374166
		05.1985	09.1992	ATE	2	38	10		X225009	X225010

90 (162)

Tout / All / Alle / Tutti / Todos		10.1984	07.1987	BREMBO	2	48	22		X284005	X284006
		10.1984	07.1987	ATE	2	38	10		X225009	X225010

145 (930)

1.4 i.e.		07.1994	12.1996	GIRL-TRW	1	54	12		X374469	X374470
		06.1995	12.1996	GIRL-TRW	1	54	12		X374265	X374266
		07.1994	12.1996	GIRL-TRW	1	34	11	Fe #ID: 4753 4754	X375083	X375084
		07.1994	12.1996	GIRL-TRW	1	34	11	Fe #ID: 941 942	X375033	X375034
1.4 i.e. 16V T.S.		12.1996	01.2001	ATE	1	54	20		X224283	X224284
		12.1996	05.1997	GIRL-TRW	1	34	11	Fe #ID: 4753 4754	X375083	X375084
		06.1997	01.2001	GIRL-TRW	1	34	11	Al	X375289	X375290
1.6 i.e.		10.1994	12.1996	GIRL-TRW	1	54	12		X374265	X374266
		10.1994	12.1996	GIRL-TRW	1	54	12		X374469	X374470
		10.1994	12.1996	GIRL-TRW	1	34	11	Fe #ID: 4753 4754	X375083	X375084
		10.1994	12.1996	GIRL-TRW	1	34	11	Fe #ID: 941 942	X375033	X375034
1.6 i.e. 16V T.S.		12.1996	01.2001	ATE	1	54	20		X224283	X224284
		12.1996	05.1997	GIRL-TRW	1	34	11	Fe #ID: 4753 4754	X375083	X375084
		06.1997	01.2001	GIRL-TRW	1	34	11	Al	X375289	X375290
1.7 i.e. 16V		06.1995	12.1996	GIRL-TRW	1	54	12		X374265	X374266
		10.1994	12.1996	GIRL-TRW	1	34	11	Fe #ID: 4753 4754	X375083	X375084
		10.1994	12.1996	GIRL-TRW	1	34	11	Fe #ID: 941 942	X375033	X375034
1.8 i.e. 16V		03.1998	01.2001	ATE	1	54	22		X224285	X224286
		03.1998	01.2001	GIRL-TRW	1	34	11	Al	X375289	X375290
1.8 i.e. 16V T.S.		12.1996	12.1998	ATE	1	54	22		X224285	X224286
		12.1996	05.1997	GIRL-TRW	1	34	11	Fe #ID: 4753 4754	X375083	X375084
		06.1997	12.1998	GIRL-TRW	1	34	11	Al	X375289	X375290
1.9 JTD		02.1999	01.2001	ATE	1	54	20		X224283	X224284
		02.1999	01.2001	GIRL-TRW	1	34	11	Al	X375289	X375290

X=1 : SNRA - X=2 : EAI - X=3 : SERA - X=4 : SEEAC - X=5 : NEOTO - X=6 : STARTCAR

Affectations par Marques

Vehicule application - Zuordnung nach Marke und Fahrzeuge - Applicazione per marca e veicolo - Aplicacion por marca y vehiculo



ALFA ROMEO



145 (930)

1.9 TD		10.1994	12.1996	GIRL-TRW	1	54	12		X374265	X374266
		10.1994	12.1996	GIRL-TRW	1	54	12		X374469	X374470
		01.1997	02.1999	ATE	1	54	20		X224283	X224284
		10.1994	05.1997	GIRL-TRW	1	34	11	Fe #ID: 4753 4754	X375083	X375084
		10.1994	02.1999	GIRL-TRW	1	34	11	Fe #ID: 941 942	X375033	X375034
		06.1997	02.1999	GIRL-TRW	1	34	11	Al	X375289	X375290
2.0 16V Quadrifoglio		03.1998	01.2001	ATE	1	54	22		X224285	X224286
		03.1998	01.2001	GIRL-TRW	1	34	11	Fe #ID: 4753 4754	X375083	X375084
		03.1998	01.2001	GIRL-TRW	1	34	11	Al	X375289	X375290
2.0 16V T.S.		10.1995	01.2001	ATE	1	54	22		X224285	X224286
		10.1995	01.2001	GIRL-TRW	1	34	11	Fe #ID: 4753 4754	X375083	X375084
		10.1995	01.2001	GIRL-TRW	1	34	11	Al	X375289	X375290

146 (930)

1.4 i.e.		05.1995	12.1996	GIRL-TRW	1	54	12		X374265	X374266
		05.1995	12.1996	GIRL-TRW	1	54	12		X374469	X374470
1.4 i.e. 16V T.S.		11.1996	01.2001	ATE	1	54	20		X224283	X224284
1.6 i.e.		05.1995	12.1996	GIRL-TRW	1	54	12		X374265	X374266
		05.1995	12.1996	GIRL-TRW	1	54	12		X374469	X374470
1.6 i.e. 16V T.S.		11.1996	01.2001	ATE	1	54	20/Ø257		X224283	X224284
1.7 i.e. 16V		05.1995	09.1996	GIRL-TRW	1	54	20/Ø257		X374267	X374268
1.8 i.e. 16V T.S.		11.1996	02.1999	ATE	1	54	22/Ø284		X224285	X224286
1.9 JTD		02.1999	01.2001	ATE	1	54	20/Ø257		X224283	X224284
1.9 TD		12.1994	12.1996	GIRL-TRW	1	54	12		X374265	X374266
		12.1994	12.1996	GIRL-TRW	1	54	12		X374469	X374470
		01.1997	02.1999	ATE	1	54	20/Ø257		X224283	X224284
2.0 16V Quadrifoglio		03.1998	01.2001	ATE	1	54	22/Ø284		X224285	X224286
2.0 16V T.S.		10.1995	01.2001	ATE	1	54	22/Ø284		X224285	X224286
Tout / All / Alle / Tutti / Todos		07.1994	01.2001	GIRL-TRW	1	34	11	Fe #ID: 4753 4754	X375083	X375084
		07.1994	01.2001	GIRL-TRW	1	34	11	Fe #ID: 941 942	X375033	X375034
		07.1994	01.2001	GIRL-TRW	1	34	11	Al	X375289	X375290

147 (937)

1.6 16V T.SPARK (937AXB1A/937AXA1A)		01.2001	03.2010	ATE	1	54	22		X224475	X224476
1.9 JTD		04.2001	09.2006	ATE	1	54	22		X224475	X224476
2.0 16V T.SPARK (937AXC1_)		01.2001	03.2010	ATE	1	54	22		X224475	X224476
3.2 GTA		02.2003	12.2007	ATE	1	54	22		X224475	X224476
		02.2003	10.2003	BREMBO	4	38/42	32		X284115	X284116
		11.2003	03.2010	BREMBO	4	38/42	28		X284153	X284154
Tout / All / Alle / Tutti / Todos		11.2000	03.2010	GIRL-TRW	1	38	10	#ID: 912 913	X375247	X375248

155 (167)

1.6 16V T.S.		05.1996	12.1997	GIRL-TRW	1	54	20		X374267	X374268
1.7 T.S.		04.1993	12.1997	GIRL-TRW	1	54	20		X374267	X374268
1.8 T.S./T.S. Sport		01.1992	12.1997	GIRL-TRW	1	54	20		X374267	X374268

X=1 : SNRA - X=2 : EAI - X=3 : SERA - X=4 : SEEC - X=5 : NEOTO - X=6 : STARTCAR

Affectations par Marques

Vehicule application - Zuordnung nach Marke und Fahrzeuge - Applicazione per marca e veicolo - Aplicacion por marca y vehiculo



155 (167)

1.9 TD (167.A3)		04.1993	12.1997	GIRL-TRW	1	54	12		X374265	X374266
		04.1993	12.1997	GIRL-TRW	1	54	12		X374469	X374470
2.0 16V Turbo Q4		05.1992	12.1997	GIRL-TRW	1	54	22/Ø284		X374165	X374166
2.0 16V Turbo Q4 (167.A2B/.A2C/.A2E)		01.1992	12.1997	GIRL-TRW	1	54	22/Ø284		X374165	X374166
2.0 T.S. 16V (167.A2G)		03.1995	12.1997	GIRL-TRW	1	54	22		X374397	X374398
2.5 TD (167.A1A)		04.1993	12.1997	GIRL-TRW	1	54	22/Ø284		X374165	X374166
2.5 V6 (167.A1)		02.1992	05.1995	GIRL-TRW	1	54	22/Ø284		X374165	X374166
2.5 V6 (167.A1C/.A1E)		10.1992	12.1997	GIRL-TRW	1	54	22/Ø284		X374165	X374166
Tout / All / Alle / Tutti / Todos		01.1992	12.1997	GIRL-TRW	1	34	11	#ID: 4753 4754	X375083	X375084
		01.1992	12.1997	GIRL-TRW	1	34	11	#ID: 941 942	X375033	X375034

156 (932)

1.6 16V T.SPARK (932A4)		09.1997	05.2006	ATE	1	54	15		X224473	X224474
		09.1997	05.2006	ATE	1	54	22		X224475	X224476
1.8 16V T.SPARK (932A3)		09.1997	10.2000	ATE	1	54	15		X224473	X224474
		09.1997	10.2000	ATE	1	54	22		X224475	X224476
1.8 16V T.SPARK (932A31__)		10.2000	09.2005	ATE	1	54	15		X224473	X224474
1.8 16V T.SPARK (932B31__)		10.2000	05.2006	ATE	1	54	15		X224473	X224474
1.9 JTD		11.2003	05.2006	ATE	1	54	22		X224475	X224476
		11.2003	09.2005	BREMBO	4	40	28		X284189	X284190
1.9 JTD (932A2B, 932A2C)		05.2001	09.2005	ATE	1	54	22		X224475	X224476
		05.2001	09.2005	BREMBO	4	40	28		X284189	X284190
1.9 JTD (932A2B__)		10.2000	05.2001	ATE	1	54	15		X224473	X224474
1.9 JTD (932B2)		09.1997	10.2000	ATE	1	54	15		X224473	X224474
1.9 JTD (932B2B, 932B2C)		05.2001	05.2006	ATE	1	54	22		X224475	X224476
		05.2001	05.2006	BREMBO	4	40	28		X284189	X284190
1.9 JTD (932B2B__)		10.2000	05.2001	ATE	1	54	15		X224473	X224474
1.9 JTD 16V		11.2002	09.2005	ATE	1	54	22		X224475	X224476
		11.2002	09.2005	BREMBO	4	40	28		X284189	X284190
1.9 JTD 16V Q4		07.2004	05.2006	ATE	1	54	22		X224475	X224476
2.0		03.2002	05.2006	ATE	1	54	22		X224475	X224476
		03.2002	05.2006	BREMBO	4	40	28		X284189	X284190
2.0 16V T.SPARK (932A2)		09.1997	06.2002	ATE	1	54	22		X224475	X224476
		08.2000	06.2002	BREMBO	4	40	28		X284189	X284190
2.0 16V T.SPARK (932A21__)		10.2000	03.2002	ATE	1	54	22		X224475	X224476
2.0 16V T.SPARK (932B21__)		10.2000	03.2002	ATE	1	54	22		X224475	X224476
2.0 JTS (932AXA)		03.2002	09.2005	ATE	1	54	22		X224475	X224476
		03.2002	09.2005	BREMBO	4	40	28		X284189	X284190
2.0 JTS (932BXA)		03.2002	05.2006	ATE	1	54	22		X224475	X224476
		03.2002	05.2006	BREMBO	4	40	28		X284189	X284190
2.0 Twin Spark		11.1997	04.2000	ATE	1	54	22		X224475	X224476
		11.1997	04.2000	BREMBO	4	40	28		X284189	X284190

X=1 : SNRA - X=2 : EAI - X=3 : SERA - X=4 : SEEAC - X=5 : NEOTO - X=6 : STARTCAR

Affectations par Marques

Vehicule application - Zuordnung nach Marke und Fahrzeuge - Applicazione per marca e veicolo - Aplicacion por marca y vehiculo



ALFA ROMEO



156 (932)

2.4 JTD		06.2003	09.2005	ATE	1	54	22		X224475	X224476
		06.2003	09.2005	BREMBO	4	40	28		X284189	X284190
2.4 JTD (932A1B__)		10.2000	09.2002	ATE	1	54	22		X224475	X224476
2.4 JTD (932AXC)		03.2002	09.2005	ATE	1	54	22		X224475	X224476
		03.2002	09.2005	BREMBO	4	40	28		X284189	X284190
2.4 JTD (932B1B__)		10.2000	05.2006	ATE	1	54	22		X224475	X224476
		10.2000	05.2006	BREMBO	4	40	28		X284189	X284190
2.4 JTD (932BXC)		03.2002	05.2006	ATE	1	54	22		X224475	X224476
		03.2002	09.2005	BREMBO	4	40	28		X284189	X284190
2.5 V6 24V (932A1)		09.1997	12.2001	ATE	1	54	22		X224475	X224476
2.5 V6 24V (932B11_)		10.2000	05.2006	ATE	1	54	22		X224475	X224476
3.2 GTA (932AXB/BXB)		03.2002	07.2003	BREMBO	4	38/42	32		X284115	X284116
		08.2003	09.2005	BREMBO	4	38/42	28		X284153	X284154
Tout / All / Alle / Tutti / Todos		09.1997	05.2006	GIRL-TRW	1	38	10	#ID: 3232596_	X375145	X375146
		09.1997	05.2006	GIRL-TRW	1	38	10	#ID: 912 913	X375247	X375248

159 (939)

1.8 MPI		03.2007	12.2007	ATE	1	60	28		X224665	X224666
1.8 TBi		05.2009	11.2011	BREMBO	4	42	28/Ø305		X284235	X284236
		05.2009	11.2011	BREMBO	4	42	28/Ø330		X284155	X284156
1.9 JTDM 16V		09.2005	12.2007	ATE	1	60	28		X224665	X224666
1.9 JTDM 8V		09.2005	11.2011	ATE	1	60	28		X224665	X224666
1.9 JTS		12.2005	12.2007	ATE	1	60	28		X224665	X224666
2.2 JTS		09.2005	12.2007	ATE	1	60	28		X224665	X224666
2.4 JTDM		09.2005	11.2011	BREMBO	4	42	28/Ø305		X284235	X284236
		09.2005	11.2011	BREMBO	4	42	28/Ø330		X284155	X284156
2.4 JTDM Q4		09.2007	11.2011	BREMBO	4	42	28/Ø305		X284235	X284236
		09.2007	11.2011	BREMBO	4	42	28/Ø330		X284155	X284156
3.2 JTS		02.2008	11.2011	BREMBO	4	42	28/Ø305		X284235	X284236
		02.2008	11.2011	BREMBO	4	42	28/Ø330		X284155	X284156
3.2 JTS Q4		12.2005	11.2011	BREMBO	4	42	28/Ø305		X284235	X284236
		12.2005	11.2011	BREMBO	4	42	28/Ø330		X284155	X284156
Tout / All / Alle / Tutti / Todos		09.2005	11.2011	GIRL-TRW	1	38	12		X375349	X375350
		09.2005	11.2011	GIRL-TRW	1	41	22		X375399	X375400

164 (164)

2.0 T.S. (164.A2C, 164.A2L)		06.1987	03.1988	GIRL-TRW	1	54	20		X374291	X374292
2.0 T.S. (164.A2H)		06.1987	12.1990	GIRL-TRW	1	54	20		X374291	X374292
2.5 TD (164.A1A)		06.1987	09.1992	GIRL-TRW	1	54	22		X374187	X374188
2.5 TD (164.K2A, 164.K2B)		09.1992	10.1997	GIRL-TRW	1	57	22		X374211	X374212
2.5 V6		09.1992	09.1998	GIRL-TRW	1	57	22		X374211	X374212
3.0		04.1993	02.1995	GIRL-TRW	1	57	22		X374211	X374212
3.0 24V		03.1995	10.1997	GIRL-TRW	1	57	22		X374211	X374212
3.0 24V (164.K1)		09.1992	09.1998	GIRL-TRW	1	57	22		X374211	X374212

X=1 : SNRA - X=2 : EAI - X=3 : SERA - X=4 : SEEC - X=5 : NEOTO - X=6 : STARTCAR

Affectations par Marques

Vehicule application - Zuordnung nach Marke und Fahrzeuge - Applicazione per marca e veicolo - Aplicacion por marca y vehiculo



ALFA ROMEO



164 (164)

3.0 24V Q4 (164.K1M, 164.K1C)		02.1994	09.1998	GIRL-TRW	1	57	22		X374211	X374212
3.0 24V QV (164.H1)		09.1992	09.1998	GIRL-TRW	1	57	22		X374211	X374212
3.0 24V QV Traction intégrale		11.1992	10.1997	GIRL-TRW	1	57	22		X374211	X374212
3.0 V6 (164.H1A, 164.H1B, 164.K1P)		09.1992	09.1998	GIRL-TRW	1	57	22		X374211	X374212
Tout / All / Alle / Tutti / Todos		06.1987	09.1998	GIRL-TRW	1	38	10		X375045	X375046

166 (936)

2.0 T.Spark (936A3A__)		09.1998	10.2000	ATE	1	57	26		X224603	X224604
2.0 T.Spark (936A3B__)		10.2000	06.2007	ATE	1	57	26		X224603	X224604
2.0 V6 (936A3__)		09.1998	10.2000	BREMBO	4	38/42	28		X284125	X284126
		09.1998	10.2000	BREMBO	4	38/42	28		X284185	X284186
2.4 JTD		04.2002	06.2007	ATE	1	57	26		X224603	X224604
		10.2003	10.2005	BREMBO	4	38/42	28		X284125	X284126
		10.2003	10.2005	BREMBO	4	38/42	28		X284185	X284186
2.4 JTD (936A2A__)		09.1998	10.2000	ATE	1	57	26		X224603	X224604
2.4 JTD (936A2B__)		10.2000	06.2003	ATE	1	57	26		X224603	X224604
2.5 V6 24V (936A2__)		09.1998	10.2000	BREMBO	4	38/42	28		X284125	X284126
		09.1998	10.2000	BREMBO	4	38/42	28		X284185	X284186
2.5 V6 24V (936A21__)		10.2000	06.2007	BREMBO	4	38/42	28		X284125	X284126
		10.2000	06.2007	BREMBO	4	38/42	28		X284185	X284186
3.0 V6 24V (936A1__)		09.1998	10.2000	BREMBO	4	38/42	28		X284125	X284126
		09.1998	10.2000	BREMBO	4	38/42	28		X284185	X284186
3.0 V6 24V (936A11__)		10.2000	06.2007	BREMBO	4	38/42	28		X284125	X284126
		10.2000	06.2007	BREMBO	4	38/42	28		X284185	X284186
3.2 V6 24V		10.2003	06.2007	BREMBO	4	38/42	28		X284125	X284126
		10.2003	06.2007	BREMBO	4	38/42	28		X284185	X284186
Tout / All / Alle / Tutti / Todos		09.1998		GIRL-TRW	1	38	10		X375145	X375146

1750-2000

Tout / All / Alle / Tutti / Todos		03.1968		ATE	2	48	12,6		X224361	X224362
		03.1968		ATE	2	38	9,4		X225127	X225128

ALFASUD (901/902.A)

Tout / All / Alle / Tutti / Todos		06.1972		ATE	2	42	10		X224075	X224076
		06.1972		ATE	2	33	9		X225031	X225032

ALFETTA (116)

Tout / All / Alle / Tutti / Todos		01.1974	12.1984	ATE	2	48	11		X224295	X224296
		01.1974	12.1984	ATE	2	38	10		X225009	X225010

ARNA (920)

Tout / All / Alle / Tutti / Todos		03.1983	12.1986	BENDIX	1	48	11		X254021	X254022
		03.1983	12.1986	BENDIX	1	48	12,7		X254127	X254128

BRERA

1.8 TBi		05.2009	03.2011	BREMBO	4	42	28/Ø305		X284235	X284236
		05.2009	03.2011	BREMBO	4	42	28/Ø330		X284155	X284156

X=1 : SNRA - X=2 : EAI - X=3 : SERA - X=4 : SEEC - X=5 : NEOTO - X=6 : STARTCAR

Affectations par Marques

Vehicule application - Zuordnung nach Marke und Fahrzeuge - Applicazione per marca e veicolo - Aplicacion por marca y vehiculo



ALFA ROMEO



BRERA

2.2 JTS		01.2006	12.2007	ATE	1	60	28		X224665	X224666
2.4 JTDM 20V		01.2006	03.2011	BREMBO	4	42	28/Ø305		X284235	X284236
		01.2006	03.2011	BREMBO	4	42	28/Ø330		X284155	X284156
3.2 JTS		03.2008	03.2011	BREMBO	4	42	28/Ø305		X284235	X284236
		03.2008	03.2011	BREMBO	4	42	28/Ø330		X284155	X284156
3.2 JTS Q4		01.2006	03.2011	BREMBO	4	42	28/Ø305		X284235	X284236
		01.2006	03.2011	BREMBO	4	42	28/Ø330		X284155	X284156
Tout / All / Alle / Tutti / Todos		01.2006	03.2011	GIRL-TRW	1	41	22		X375399	X375400
		03.2008	03.2011	GIRL-TRW	1	38	12		X375349	X375350

GIULIA

Tout / All / Alle / Tutti / Todos		01.1966	12.1979	ATE	2	48	11		X224295	X224296
		01.1966	12.1979	ATE	2	38	9,4		X225127	X225128

GIULIETTA (116)

Tout / All / Alle / Tutti / Todos		09.1977	12.1985	ATE	2	48	12,7		X224089	X224090
		09.1977	12.1985	ATE	2	38	10		X225009	X225010

GIULIETTA (940)

Tout / All / Alle / Tutti / Todos		04.2010		ATE	1	57	26/Ø281		X224853	X224854
		04.2010		ATE	1	57	28/Ø305		X224851	X224852
		04.2010		BREMBO	4	40	28		X284189	X284190
		04.2010		GIRL-TRW	1	38	10/Ø264		X375453	X375454
		04.2010		GIRL-TRW	1	38	12/Ø278		X375455	X375456

GT

Tout / All / Alle / Tutti / Todos		01.1966	12.1978	ATE	2	48	11		X224295	X224296
		01.1966	12.1978	ATE	2	38	9,4		X225127	X225128

GT (937)

1.8 TS		11.2003	09.2010	ATE	1	54	22		X224475	X224476
1.9 JTD		11.2003	09.2010	ATE	1	54	22		X224475	X224476
2.0 JTS		11.2003	09.2010	ATE	1	54	22		X224475	X224476
3.2 GTA		11.2003	09.2010	BREMBO	4	38/42	28		X284153	X284154
Tout / All / Alle / Tutti / Todos		11.2003	09.2010	GIRL-TRW	1	38	10		X375247	X375248

GTV (116)

Tout / All / Alle / Tutti / Todos		11.1980	02.1987	ATE	2	48	11		X224089	X224090
		11.1980	02.1987	ATE	2	48	22		X224099	X224100
		11.1980	02.1987	ATE	2	38	10		X225009	X225010

GTV (916C_)

1.8 16V (916C3)		05.1998	03.2003	ATE	1	54	22		X224285	X224286
2.0 JTS		04.2003	10.2004	ATE	1	54	22		X224285	X224286
2.0 T.SPARK 16V (916.C2_, 916C2C00)		06.1995	10.2005	ATE	1	54	22		X224285	X224286
		06.1995	10.2005	BREMBO	4	38/42	32		X284115	X284116
		06.1995	10.2005	GIRL-TRW	1	54	22		X374397	X374398
2.0 T.SPARK 16V (916C2C)		05.1998	08.2000	ATE	1	54	22		X224285	X224286

X=1 : SNRA - X=2 : EAI - X=3 : SERA - X=4 : SEEC - X=5 : NEOTO - X=6 : STARTCAR

Affectations par Marques

Vehicule application - Zuordnung nach Marke und Fahrzeuge - Applicazione per marca e veicolo - Aplicacion por marca y vehiculo



ALFA ROMEO



GTV (916C_)

2.0 V6 Turbo (916.C2A)		06.1995	09.1998	ATE	1	54	22		X224285	X224286
3.0 V6 24V (916.C1)		10.1996	10.2000	BREMBO	4	38/42	32		X284115	X284116
3.0 V6 24V (916.C1B_)		10.2000	03.2003	BREMBO	4	38/42	32		X284115	X284116
3.2 V6 24V		04.2003	10.2004	BREMBO	4	38/42	32		X284115	X284116
Tout / All / Alle / Tutti / Todos		06.1995	10.2005	GIRL-TRW	1	34	11	Fe #ID: 4753 4754	X375083	X375084
		06.1995	10.2005	GIRL-TRW	1	34	11	Fe #ID: 941 942	X375033	X375034
		06.1995	10.2005	GIRL-TRW	1	34	11	Al	X375289	X375290

MITO (955)

0.9		07.2011		BOSCH	1	54	22/Ø257		X274071	X274072
1.3 JTDM		09.2008	12.2011	BOSCH	1	57	26/Ø281		X274035	X274036
1.4		09.2008		BOSCH	1	54	22/Ø257		X274071	X274072
		09.2008		BOSCH	1	57	26/Ø281		X274035	X274036
1.4 Bifuel		07.2011		BOSCH	1	57	26/Ø281		X274035	X274036
1.4 TB		09.2008	09.2010	BREMBO	4	40	28		X284187	X284188
		10.2009		BOSCH	1	57	26/Ø281		X274035	X274036
1.4 Turbo		09.2008	06.2011	BOSCH	1	57	26/Ø281		X274035	X274036
1.6 JTDM		09.2008		BOSCH	1	57	26		X274035	X274036
		09.2008		BREMBO	4	40	28		X284187	X284188
Tout / All / Alle / Tutti / Todos		09.2008		BOSCH	1	38	10		X275061	X275062
		09.2008		GIRL-TRW	1	38	10		X375437	X375438

RZ

Tout / All / Alle / Tutti / Todos		01.1992	12.1994	ATE	2	38	20		X225333	X225334
-----------------------------------	--	---------	---------	-----	---	----	----	--	---------	---------

SPIDER (105/115)

Tout / All / Alle / Tutti / Todos		01.1971	12.1993	ATE	2	48	12,6		X224361	X224362
		01.1971	12.1993	ATE	2	38	9,4		X225127	X225128

SPIDER (916S_)

1.8 16V (916S3)		05.1998	03.2003	ATE	1	54	22		X224285	X224286
2.0 JTS		04.2003	04.2005	ATE	1	54	22		X224285	X224286
2.0 T.SPARK 16V (916S2B)		05.1998	08.2000	ATE	1	54	22		X224285	X224286
2.0 T.SPARK 16V (916S2C00)		06.1995	04.2005	ATE	1	54	22		X224285	X224286
2.0 V6 Turbo (916S2A)		05.1998	04.2005	ATE	1	54	22		X224285	X224286
3.0 V6 (916S1)		06.1995	04.2005	ATE	1	54	22		X224285	X224286
		06.1995	04.2005	GIRL-TRW	1	54	22		X374397	X374398
3.0 V6 24V		01.1999	10.2000	BREMBO	4	38/42	32		X284115	X284116
3.2 V6 24V		04.2003	04.2005	BREMBO	4	38/42	32		X284115	X284116
Tout / All / Alle / Tutti / Todos		06.1995	04.2005	GIRL-TRW	1	34	11	#ID: 4753 4754	X375083	X375084
		06.1995	04.2005	GIRL-TRW	1	34	11	#ID: 941 942	X375033	X375034

Affectations par Marques

Vehicule application - Zuordnung nach Marke und Fahrzeuge - Applicazione per marca e veicolo - Aplicacion por marca y vehiculo



ALFA ROMEO



SPIDER (939)

Tout / All / Alle / Tutti / Todos		09.2006		ATE	1	60	28			X224665	X224666
		09.2006		BREMBO	4	42	28/Ø305			X284235	X284236
		09.2006		BREMBO	4	42	28/Ø330			X284155	X284156
		09.2006		GIRL-TRW	1	38	12			X375349	X375350
		09.2006		GIRL-TRW	1	41	22			X375399	X375400

SZ

Tout / All / Alle / Tutti / Todos		09.1988		ATE	2	38	20			X225333	X225334
-----------------------------------	--	---------	--	-----	---	----	----	--	--	---------	---------



ALPINE



1600

Tout / All / Alle / Tutti / Todos		01.1969	12.1975	BENDIX	1	38				X254151	X254152
		01.1969	12.1975	BENDIX	1	48			16055->	X254261	X254262
		01.1969	12.1975	BENDIX	1	32				X255041	X255042
		01.1969	12.1975	BENDIX	1	45			16055->	X255043	X255044

1100-1300

Tout / All / Alle / Tutti / Todos		01.1970	12.1975	BENDIX	1	38				X254151	X254152
		01.1970	12.1975	BENDIX	1	32				X255041	X255042

A110

Tout / All / Alle / Tutti / Todos		01.1966	12.1970	BENDIX	1	48				X254179	X254180
		01.1966	12.1970	BENDIX	1	45				X255043	X255044

A310

Tout / All / Alle / Tutti / Todos		01.1971	12.1984	BENDIX	1	48				X254041	X254042
		01.1971	12.1984	BENDIX	1	48				X254179	X254180
		01.1971	12.1984	BENDIX	1	45				X255043	X255044
		01.1971	12.1984	BENDIX	1	54				X255011	X255012

A610

Tout / All / Alle / Tutti / Todos		01.1991		GIRL-TRW	1	60	24/Ø280			X374369	X374370
		01.1991		BENDIX	1	57				X255075	X255076

V6

Tout / All / Alle / Tutti / Todos		01.1985		GIRL-TRW	1	54	20			X374009	X374010
		01.1985		BENDIX	1	50				X255057	X255058



ASA



1000 GT

Tout / All / Alle / Tutti / Todos		01.1964	12.1967	GIRL-TRW	3	24/34				X375287	X375288
-----------------------------------	--	---------	---------	----------	---	-------	--	--	--	---------	---------

1600

Tout / All / Alle / Tutti / Todos		01.1961	12.1964	GIRL-TRW	3	30/43				X375211	X375212
-----------------------------------	--	---------	---------	----------	---	-------	--	--	--	---------	---------

2400

Tout / All / Alle / Tutti / Todos		01.1961	12.1964	GIRL-TRW	3	38/54				X374571	X374572
		01.1961	12.1964	GIRL-TRW	3	30/43				X375211	X375212

X=1 : SNRA - X=2 : EAI - X=3 : SERA - X=4 : SEEAC - X=5 : NEOTO - X=6 : STARTCAR

Affectations par Marques

Vehicule application - Zuordnung nach Marke und Fahrzeuge - Applicazione per marca e veicolo - Aplicacion por marca y vehiculo



ASIA MOTORS



ROCSTA

Tout / All / Alle / Tutti / Todos		11.1989	12.1999	KPW	1	57	20			X414001	X414002
-----------------------------------	--	---------	---------	-----	---	----	----	--	--	---------	---------



ASTON MARTIN



DB2 III

Tout / All / Alle / Tutti / Todos		01.1958	12.1959	GIRL-TRW	2	60				X374579	X374580
-----------------------------------	--	---------	---------	----------	---	----	--	--	--	---------	---------

DB4 GT

Tout / All / Alle / Tutti / Todos		01.1961	12.1963	GIRL-TRW	2	60				X374579	X374580
-----------------------------------	--	---------	---------	----------	---	----	--	--	--	---------	---------

DB5

Tout / All / Alle / Tutti / Todos		09.1963	12.1965	GIRL-TRW	3	30/43				X375235	X375236
-----------------------------------	--	---------	---------	----------	---	-------	--	--	--	---------	---------

DB6

Tout / All / Alle / Tutti / Todos		04.1969	01.1971	GIRL-TRW	3	40/57				X374499	X374500
		01.1966	03.1969	GIRL-TRW	3	30/43				X375235	X375236
		04.1969	01.1971	GIRL-TRW	3	30/43				X375235	X375236

DBS

Tout / All / Alle / Tutti / Todos		11.1967	12.1972	GIRL-TRW	3	40/57				X374499	X374500
		11.1967	12.1972	GIRL-TRW	3	30/43				X375235	X375236



AUDI



60

Tout / All / Alle / Tutti / Todos		09.1968		ATE	2	48	10,5			X224321	X224322
-----------------------------------	--	---------	--	-----	---	----	------	--	--	---------	---------

75

Tout / All / Alle / Tutti / Todos		09.1968		ATE	2	48	10,5			X224321	X224322
-----------------------------------	--	---------	--	-----	---	----	------	--	--	---------	---------

80 (80, 82, B1)

1.3		05.1972	07.1978	ATE	1	44	10			X224067	X224068
		05.1972	12.1972	ATE	2	48	10,5			X224321	X224322
1.5		05.1972	07.1976	ATE	1	44	10			X224067	X224068
		05.1972	08.1975	ATE	1	44	12			X224111	X224112
		05.1972	12.1972	ATE	2	48	10,5			X224321	X224322
1.6		09.1975	07.1978	ATE	1	44	12			X224111	X224112
		09.1975	07.1978	GIRL-TRW	1	48	12			X374081	X374082

80 (81, 85, B2)

1.3		09.1978	07.1986	GIRL-TRW	1	48	12			X374081	X374082
1.6		08.1978	05.1984	GIRL-TRW	1	48	12			X374081	X374082
1.6 D		08.1980	08.1986	GIRL-TRW	1	48	12			X374081	X374082
1.6 GLE		01.1979	12.1986	GIRL-TRW	1	48	12			X374081	X374082
1.6 TD		08.1981	05.1986	GIRL-TRW	1	48	12			X374081	X374082
1.8		01.1983	08.1986	GIRL-TRW	1	48	12			X374081	X374082
1.8 CC quattro (85Q)		08.1984	08.1986	GIRL-TRW	1	54	13			X374037	X374038
		08.1984	08.1986	GIRL-TRW	1	36	10			X375021	X375022
1.8 GTE		10.1984	08.1986	GIRL-TRW	1	48	12			X374081	X374082

X=1 : SNRA - X=2 : EAI - X=3 : SERA - X=4 : SEEAC - X=5 : NEOTO - X=6 : STARTCAR

Affectations par Marques

Vehicule application - Zuordnung nach Marke und Fahrzeuge - Applicazione per marca e veicolo - Aplicacion por marca y vehiculo



AUDI



80 (81, 85, B2)

1.8 GTE quattro (85Q)		08.1984	08.1986	GIRL-TRW	1	54	13		X374037	X374038
		03.1985	08.1986	GIRL-TRW	1	48	12		X374081	X374082
		08.1984	08.1986	GIRL-TRW	1	36	10		X375021	X375022
1.9 CD-5S		09.1981	07.1983	GIRL-TRW	1	48	12		X374081	X374082
2.0		10.1983	09.1984	GIRL-TRW	1	48	12		X374081	X374082
2.0 quattro (85Q)		10.1983	09.1984	GIRL-TRW	1	54	13		X374037	X374038
		10.1983	09.1984	GIRL-TRW	1	36	10		X375021	X375022
2.2		10.1980	07.1983	GIRL-TRW	1	48	12		X374081	X374082
2.2 quattro (85Q)		08.1982	07.1984	GIRL-TRW	1	54	13		X374037	X374038
		08.1982	07.1984	GIRL-TRW	1	36	10		X375027	X375028

80 (89, 89Q, 8A, B3)

1.4		08.1986	07.1988	GIRL-TRW	1	54	13		X374037	X374038
1.6		09.1986	10.1991	GIRL-TRW	1	54	13		X374037	X374038
		08.1987	09.1991	GIRL-TRW	1	36	10		X375003	X375004
1.6 D		09.1986	08.1991	GIRL-TRW	1	54	13		X374037	X374038
		09.1986	08.1991	ATE	1	36	10		X225013	X225014
1.6 TD		09.1986	08.1991	GIRL-TRW	1	54	13		X374037	X374038
		09.1986	08.1991	ATE	1	36	10		X225013	X225014
1.8		09.1986	01.1990	GIRL-TRW	1	54	13		X374037	X374038
		09.1986	07.1988	GIRL-TRW	1	36	10		X375003	X375004
1.8 E		06.1986	08.1991	ATE	1	54	22		X224181	X224182
		06.1986	08.1991	GIRL-TRW	1	54	22		X374359	X374360
		06.1986	07.1989	GIRL-TRW	1	36	10		X375003	X375004
		08.1989	08.1991	GIRL-TRW	1	38	10		X375063	X375064
1.8 E quattro		09.1986	08.1991	ATE	1	54	22		X224181	X224182
		09.1986	08.1991	GIRL-TRW	1	54	22		X374359	X374360
		09.1986	08.1991	GIRL-TRW	1	36	10		X375021	X375022
		09.1986	08.1991	GIRL-TRW	1	38	10		X375049	X375050
1.8 quattro		09.1986	07.1988	ATE	1	54	22		X224181	X224182
		09.1986	07.1988	GIRL-TRW	1	54	22		X374359	X374360
		09.1986	07.1988	GIRL-TRW	1	36	10		X375021	X375022
		09.1986	07.1988	GIRL-TRW	1	38	10		X375049	X375050
1.8 S		09.1986	12.1990	GIRL-TRW	1	54	13		X374037	X374038
1.8 S quattro		09.1986	07.1990	GIRL-TRW	1	54	13		X374037	X374038
		09.1986	07.1990	GIRL-TRW	1	36	10		X375021	X375022
		09.1986	07.1990	GIRL-TRW	1	38	10		X375049	X375050
1.9 D		08.1989	08.1991	GIRL-TRW	1	54	13		X374037	X374038
2.0		10.1990	08.1991	ATE	1	54	22		X224181	X224182
		10.1990	08.1991	GIRL-TRW	1	54	22		X374359	X374360
		10.1990	08.1991	GIRL-TRW	1	38	10		X375063	X375064

Affectations par Marques

Vehicule application - Zuordnung nach Marke und Fahrzeuge - Applicazione per marca e veicolo - Aplicacion por marca y vehiculo



AUDI



80 (89, 89Q, 8A, B3)

2.0 E		08.1988	10.1990	ATE	1	54	22		X224181	X224182
		08.1988	10.1990	GIRL-TRW	1	54	22		X374359	X374360
		08.1988	07.1989	GIRL-TRW	1	36	10		X375003	X375004
		08.1989	10.1990	GIRL-TRW	1	38	10		X375063	X375064
2.0 E 16V		03.1990	09.1991	ATE	1	54	22		X224181	X224182
		03.1990	09.1991	GIRL-TRW	1	54	22		X374359	X374360
		03.1990	09.1991	GIRL-TRW	1	38	10		X375063	X375064
2.0 E 16V quattro		03.1990	08.1991	ATE	1	54	22		X224181	X224182
		03.1990	08.1991	GIRL-TRW	1	54	22		X374359	X374360
		03.1990	08.1991	GIRL-TRW	1	36	10		X375021	X375022
		03.1990	08.1991	GIRL-TRW	1	38	10		X375049	X375050
2.0 E quattro		08.1988	09.1990	ATE	1	54	22		X224181	X224182
		08.1988	09.1990	GIRL-TRW	1	54	22		X374359	X374360
		08.1988	09.1990	GIRL-TRW	1	36	10		X375021	X375022
		08.1988	09.1990	GIRL-TRW	1	38	10		X375049	X375050
2.0 quattro		08.1988	08.1991	ATE	1	54	22		X224181	X224182
		08.1988	08.1991	GIRL-TRW	1	54	22		X374359	X374360
		08.1988	08.1991	GIRL-TRW	1	36	10		X375021	X375022
		08.1988	08.1991	GIRL-TRW	1	38	10		X375049	X375050
2.3 quattro		10.1987	07.1989	ATE	1	54	22		X224181	X224182
		10.1987	07.1989	GIRL-TRW	1	54	22		X374359	X374360
		10.1987	07.1989	GIRL-TRW	1	36	10		X375021	X375022
		10.1987	07.1989	GIRL-TRW	1	38	10		X375049	X375050

80 (8C, B4)

1.6		09.1991	12.1994	GIRL-TRW	1	54	13		X374037	X374038
		09.1991	12.1994	GIRL-TRW	1	54	13		X374191	X374192
		09.1991	12.1994	GIRL-TRW	1	54	22		X374359	X374360
1.6 E		06.1993	12.1994	GIRL-TRW	1	54	22		X374359	X374360
		06.1993	12.1994	GIRL-TRW	1	38	10		X375047	X375048
1.9 TD		09.1991	12.1994	GIRL-TRW	1	54	13		X374037	X374038
		09.1991	12.1994	GIRL-TRW	1	54	13		X374191	X374192
		09.1991	07.1992	GIRL-TRW	1	54	22		X374359	X374360
		09.1991	12.1994	GIRL-TRW	1	38	10		X375047	X375048
1.9 TDI		09.1991	07.1995	GIRL-TRW	1	54	13		X374037	X374038
		09.1991	07.1995	GIRL-TRW	1	54	13		X374191	X374192
		09.1991	12.1994	GIRL-TRW	1	54	22		X374359	X374360
		07.1992	07.1995	GIRL-TRW	1	54	22		X374133	X374134
		09.1991	12.1994	GIRL-TRW	1	38	10		X375047	X375048
2.0		09.1991	01.1996	GIRL-TRW	1	54	13		X374191	X374192
		09.1991	01.1996	GIRL-TRW	1	54	22		X374359	X374360
		09.1991	07.1992	GIRL-TRW	2	^{40/45}	25		X374361	X374362
		07.1992	06.1995	GIRL-TRW	1	54	13		X374037	X374038

X=1 : SNRA - X=2 : EAI - X=3 : SERA - X=4 : SEEAC - X=5 : NEOTO - X=6 : STARTCAR

Affectations par Marques

Vehicule application - Zuordnung nach Marke und Fahrzeuge - Applicazione per marca e veicolo - Aplicacion por marca y vehiculo



AUDI



80 (8C, B4)

2.0 E		09.1991	07.1992	GIRL-TRW	1	54	22		X374359	X374360
		09.1991	12.1994	GIRL-TRW	2	40/45	25		X374361	X374362
		09.1991	01.1996	GIRL-TRW	1	38	10		X375047	X375048
2.0 E 16V		09.1991	07.1992	ATE	1	54	22		X224181	X224182
		09.1991	07.1995	GIRL-TRW	1	54	22		X374359	X374360
		09.1991	07.1992	GIRL-TRW	1	38	10		X375005	X375006
		08.1992	07.1995	GIRL-TRW	1	38	10		X375047	X375048
2.0 E 16V quattro		04.1992	07.1995	GIRL-TRW	1	54	22		X374359	X374360
		12.1992	07.1995	GIRL-TRW	1	38	10		X375051	X375052
2.0 E quattro		09.1991	12.1994	GIRL-TRW	1	54	22		X374359	X374360
		09.1991	12.1994	GIRL-TRW	1	38	10		X375051	X375052
2.0 quattro		11.1993	07.1995	GIRL-TRW	1	54	22		X374359	X374360
		11.1993	07.1995	GIRL-TRW	1	38	10		X375051	X375052
2.3 E		09.1991	11.1994	GIRL-TRW	1	54	22		X374359	X374360
		09.1991	01.1996	GIRL-TRW	1	38	10		X375047	X375048
2.3 E quattro		09.1991	12.1994	GIRL-TRW	1	54	22		X374359	X374360
		09.1991	12.1994	GIRL-TRW	1	38	10		X375051	X375052
2.6		07.1992	12.1994	GIRL-TRW	1	54	22		X374359	X374360
		07.1992	12.1994	GIRL-TRW	1	38	10		X375047	X375048
2.6 quattro		06.1992	07.1995	GIRL-TRW	1	54	22		X374359	X374360
		06.1992	07.1995	GIRL-TRW	1	38	10		X375051	X375052
2.8		09.1991	07.1992	GIRL-TRW	1	54	13		X374191	X374192
		09.1991	12.1994	GIRL-TRW	1	54	13		X374037	X374038
		09.1991	07.1992	GIRL-TRW	1	54	22		X374359	X374360
		09.1991	12.1994	GIRL-TRW	2	40/45	25		X374361	X374362
		09.1991	12.1994	GIRL-TRW	1	38	10		X375047	X375048
2.8 quattro		09.1991	07.1995	GIRL-TRW	2	40/45	25		X374361	X374362
		09.1991	07.1995	GIRL-TRW	1	38	10		X375051	X375052

90 (81, 85, B2)

1.6 TD		10.1985	01.1987	GIRL-TRW	1	54	13		X374037	X374038
2.0		10.1984	03.1987	GIRL-TRW	1	54	13		X374037	X374038
		03.1986	03.1987	GIRL-TRW	1	48	12		X374081	X374082
		03.1986	03.1987	ATE	1	36	10		X225013	X225014
2.0 quattro		08.1984	08.1986	GIRL-TRW	1	54	13		X374037	X374038
		08.1984	08.1986	GIRL-TRW	1	36	10		X375021	X375022
2.2		10.1984	03.1987	GIRL-TRW	1	54	13		X374037	X374038
		10.1984	03.1987	GIRL-TRW	1	36	10		X375003	X375004
2.2 E quattro		11.1984	08.1986	GIRL-TRW	1	54	13		X374037	X374038
		11.1984	08.1986	GIRL-TRW	1	36	10		X375021	X375022

90 (89, 89Q, 8A, B3)

1.6 TD		04.1987	09.1991	GIRL-TRW	1	54	13		X374037	X374038
--------	--	---------	---------	----------	---	----	----	--	---------	---------

Affectations par Marques

Vehicule application - Zuordnung nach Marke und Fahrzeuge - Applicazione per marca e veicolo - Aplicacion por marca y vehiculo



AUDI



90 (89, 89Q, 8A, B3)

2.0		07.1988	09.1991	ATE	1	54	22		X224181	X224182
		07.1988	09.1991	GIRL-TRW	1	54	22		X374359	X374360
		07.1988	07.1989	GIRL-TRW	1	36	10		X375003	X375004
		08.1989	09.1991	GIRL-TRW	1	38	10		X375063	X375064
2.0 20 V		08.1989	07.1991	ATE	1	54	22		X224181	X224182
		08.1989	07.1991	GIRL-TRW	1	54	22		X374359	X374360
		08.1989	07.1991	GIRL-TRW	1	38	10		X375063	X375064
2.0 20 V quattro		08.1988	09.1991	ATE	1	54	22		X224181	X224182
		08.1988	09.1991	GIRL-TRW	1	54	22		X374359	X374360
		08.1988	09.1991	GIRL-TRW	1	36	10		X375021	X375022
		08.1988	09.1991	GIRL-TRW	1	38	10		X375049	X375050
2.0 quattro		08.1989	07.1990	ATE	1	54	22		X224181	X224182
		08.1989	07.1990	GIRL-TRW	1	54	22		X374359	X374360
		08.1989	07.1990	GIRL-TRW	1	36	10		X375021	X375022
		08.1989	07.1990	GIRL-TRW	1	38	10		X375049	X375050
2.2 E		04.1987	07.1991	ATE	1	54	22		X224181	X224182
		04.1987	07.1991	GIRL-TRW	1	54	22		X374359	X374360
		04.1987	07.1989	GIRL-TRW	1	36	10		X375003	X375004
		08.1989	07.1991	GIRL-TRW	1	38	10		X375063	X375064
2.2 E quattro		04.1987	09.1991	ATE	1	54	22		X224181	X224182
		04.1987	09.1991	GIRL-TRW	1	54	22		X374359	X374360
		04.1987	09.1991	GIRL-TRW	1	36	10		X375021	X375022
		04.1987	09.1991	GIRL-TRW	1	38	10		X375049	X375050
2.3 E		04.1987	07.1991	ATE	1	54	22		X224181	X224182
		04.1987	07.1991	GIRL-TRW	1	54	22		X374359	X374360
		04.1987	07.1989	GIRL-TRW	1	36	10		X375003	X375004
		08.1989	07.1991	GIRL-TRW	1	38	10		X375063	X375064
2.3 E 20V		08.1988	07.1989	GIRL-TRW	1	36	10		X375003	X375004
		08.1989	07.1991	GIRL-TRW	1	38	10		X375063	X375064
2.3 E 20V quattro		06.1988	09.1991	GIRL-TRW	2	40/45	25		X374361	X374362
		06.1988	09.1991	GIRL-TRW	1	36	10		X375021	X375022
		06.1988	09.1991	GIRL-TRW	1	38	10		X375049	X375050
2.3 E quattro		04.1987	07.1991	ATE	1	54	22		X224181	X224182
		04.1987	07.1991	GIRL-TRW	1	54	22		X374359	X374360
		04.1987	07.1991	GIRL-TRW	1	36	10		X375021	X375022
		04.1987	07.1991	GIRL-TRW	1	38	10		X375049	X375050

100 (43, C2)

1.6		08.1976	07.1982	ATE	1	48	13		X224093	X224094
		08.1976	02.1983	GIRL-TRW	1	54	13		X374037	X374038
1.9		08.1980	07.1982	GIRL-TRW	1	54	22		X374137	X374138
2.0		06.1976	07.1980	ATE	1	48	13		X224093	X224094
		08.1977	07.1980	GIRL-TRW	1	48	12		X374115	X374116

X=1 : SNRA - X=2 : EAI - X=3 : SERA - X=4 : SEEAC - X=5 : NEOTO - X=6 : STARTCAR

Affectations par Marques

Vehicule application - Zuordnung nach Marke und Fahrzeuge - Applicazione per marca e veicolo - Aplicacion por marca y vehiculo



AUDI



100 (43, C2)











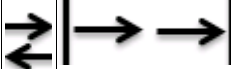



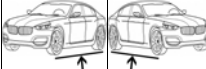









































2.0 D		08.1978	07.1982	GIRL-TRW	1	54	13		X374037	X374038
		08.1978	02.1983	GIRL-TRW	1	54	22		X374137	X374138
2.1		03.1977	02.1983	ATE	1	48	13		X224093	X224094
		03.1977	02.1983	GIRL-TRW	1	54	22		X374137	X374138

100 (44, 44Q, C3)

1.8		08.1982	07.1990	ATE	1	54	22		X224181	X224182
		08.1982	07.1990	ATE	1	54	22		X224191	X224192
		08.1982	07.1990	GIRL-TRW	1	54	13		X374037	X374038
		08.1982	07.1990	GIRL-TRW	1	54	22		X374133	X374134
1.8 CAT		03.1985	11.1990	ATE	1	54	22		X224181	X224182
		03.1985	11.1990	ATE	1	54	22		X224191	X224192
		03.1985	11.1990	GIRL-TRW	1	54	13		X374037	X374038
		03.1985	11.1990	GIRL-TRW	1	54	22		X374133	X374134
1.8 quattro/CAT		10.1984	10.1990	GIRL-TRW	1	54	22		X374133	X374134
		10.1984	10.1990	GIRL-TRW	1	36	10		X375021	X375022
		10.1984	10.1990	GIRL-TRW	1	43	20		X375023	X375024
		10.1984	10.1990	GIRL-TRW	1	43	20		X375131	X375132
1.9		08.1982	07.1984	GIRL-TRW	1	54	13		X374037	X374038
		02.1983	07.1984	GIRL-TRW	1	54	22		X374133	X374134
2.0		08.1984	02.1987	ATE	1	54	22		X224191	X224192
		08.1984	12.1987	ATE	1	54	22		X224181	X224182
		08.1984	12.1987	GIRL-TRW	1	54	22		X374133	X374134
2.0 CAT		01.1988	11.1990	ATE	1	54	22		X224181	X224182
		01.1988	11.1990	GIRL-TRW	1	54	22		X374133	X374134
2.0 D		08.1982	11.1990	ATE	1	54	22		X224181	X224182
		08.1982	11.1990	ATE	1	54	22		X224191	X224192
		08.1982	11.1990	GIRL-TRW	1	54	13		X374037	X374038
		08.1982	11.1990	GIRL-TRW	1	54	22		X374133	X374134
		08.1982	11.1990	GIRL-TRW	1	36	10		X375003	X375004
2.0 E		01.1985	02.1987	ATE	1	54	22		X224191	X224192
		01.1985	12.1987	ATE	1	54	22		X224181	X224182
		01.1985	12.1987	GIRL-TRW	1	54	22		X374133	X374134
2.0 E CAT		01.1988	11.1990	ATE	1	54	22		X224181	X224182
		01.1988	11.1990	GIRL-TRW	1	54	22		X374133	X374134
2.0 TD		03.1983	02.1987	ATE	1	54	22		X224191	X224192
		03.1983	10.1987	ATE	1	54	22		X224181	X224182
		03.1983	10.1987	GIRL-TRW	1	54	22		X374133	X374134
2.1		08.1982	07.1984	ATE	1	54	22		X224191	X224192
		08.1982	07.1984	GIRL-TRW	1	54	22		X374133	X374134
		08.1982	07.1984	GIRL-TRW	1	36	10		X375003	X375004

Affectations par Marques

Vehicule application - Zuordnung nach Marke und Fahrzeuge - Applicazione per marca e veicolo - Aplicacion por marca y vehiculo

											
 AUDI 											
100 (44, 44Q, C3)											
2.2		08.1984	02.1987	ATE	1	54	22			X224191	X224192
		08.1984	12.1988	ATE	1	54	22			X224181	X224182
		08.1984	12.1988	GIRL-TRW	1	54	22			X374133	X374134
		08.1982	10.1987	GIRL-TRW	1	36	10			X375003	X375004
		08.1984	12.1988	GIRL-TRW	1	38	10			X375005	X375006
2.2 CAT		06.1989	11.1990	ATE	1	54	22			X224181	X224182
		06.1989	11.1990	GIRL-TRW	1	54	22			X374133	X374134
		06.1989	11.1990	GIRL-TRW	1	36	10			X375003	X375004
		06.1989	11.1990	GIRL-TRW	1	38	10			X375005	X375006
2.2 E quattro		08.1985	07.1986	GIRL-TRW	1	54	22			X374133	X374134
		08.1985	07.1986	GIRL-TRW	2	40/45	25			X374041	X374042
		08.1985	07.1986	GIRL-TRW	1	36	10			X375021	X375022
		08.1985	07.1986	GIRL-TRW	1	43	20			X375023	X375024
		08.1985	07.1986	GIRL-TRW	1	43	20			X375131	X375132
2.2 E Turbo quattro		08.1986	11.1990	GIRL-TRW	2	40/45	25			X374041	X374042
		08.1986	11.1990	GIRL-TRW	1	36	10			X375021	X375022
2.2 quattro		08.1984	12.1985	GIRL-TRW	1	54	22			X374133	X374134
		08.1984	12.1988	GIRL-TRW	2	40/45	25			X374041	X374042
		08.1984	12.1988	GIRL-TRW	1	36	10			X375021	X375022
		08.1984	12.1988	GIRL-TRW	1	43	20			X375023	X375024
		08.1984	12.1988	GIRL-TRW	1	43	20			X375131	X375132
2.2 quattro CAT		06.1989	11.1990	GIRL-TRW	2	40/45	25			X374041	X374042
		06.1989	11.1990	GIRL-TRW	1	36	10			X375021	X375022
		06.1989	11.1990	GIRL-TRW	1	43	20			X375023	X375024
		06.1989	11.1990	GIRL-TRW	1	43	20			X375131	X375132
2.2 Turbo		08.1986	01.1987	ATE	1	54	22			X224191	X224192
		08.1986	11.1990	ATE	1	54	22			X224181	X224182
		08.1986	11.1990	GIRL-TRW	1	54	22			X374133	X374134
		08.1986	10.1987	GIRL-TRW	1	36	10			X375003	X375004
		10.1987	11.1990	GIRL-TRW	1	38	10			X375005	X375006
		10.1987	11.1990	GIRL-TRW	1	38	10			X375005	X375006
2.2 Turbo quattro		08.1986	11.1990	GIRL-TRW	2	40/45	25			X374041	X374042
		08.1986	11.1990	GIRL-TRW	1	43	20			X375023	X375024
		08.1986	11.1990	GIRL-TRW	1	43	20			X375131	X375132
2.3		08.1986	01.1987	ATE	1	54	22			X224191	X224192
		08.1986	11.1990	ATE	1	54	22			X224181	X224182
		08.1986	11.1990	GIRL-TRW	1	54	22			X374133	X374134
		08.1986	10.1987	GIRL-TRW	1	36	10			X375003	X375004
		10.1987	11.1990	GIRL-TRW	1	38	10			X375005	X375006
		10.1987	11.1990	GIRL-TRW	1	38	10			X375005	X375006
2.3 E		10.1986	01.1987	ATE	1	54	22			X224191	X224192
		10.1986	11.1990	ATE	1	54	22			X224181	X224182
		10.1986	11.1990	GIRL-TRW	1	54	22			X374133	X374134
		10.1986	11.1990	GIRL-TRW	1	38	10			X375005	X375006

Affectations par Marques

Vehicule application - Zuordnung nach Marke und Fahrzeuge - Applicazione per marca e veicolo - Aplicacion por marca y vehiculo



AUDI



100 (4A, 44Q, C3)

2.3 E quattro		08.1986	11.1990	GIRL-TRW	2	^{40/45}	25		X374041	X374042
		08.1986	11.1990	GIRL-TRW	1	36	10		X375021	X375022
		08.1986	11.1990	GIRL-TRW	1	43	20		X375023	X375024
		08.1986	11.1990	GIRL-TRW	1	43	20		X375131	X375132
2.4 D		08.1989	11.1990	ATE	1	54	22		X224181	X224182
		08.1989	11.1990	GIRL-TRW	1	54	22		X374133	X374134
2.5 TDI		01.1990	11.1990	GIRL-TRW	1	54	22		X374133	X374134

100 (4A, C4)

2.0		12.1990	06.1994	ATE	1	57	15		X224239	X224240
2.0 E		12.1990	07.1993	ATE	1	57	15		X224239	X224240
2.0 E 16V		01.1992	06.1994	ATE	1	57	15		X224239	X224240
		01.1992	06.1994	GIRL-TRW	1	38	10		X375063	X375064
2.0 E 16V quattro		07.1992	06.1994	ATE	1	57	15		X224239	X224240
		07.1992	06.1994	GIRL-TRW	1	38	10		X375049	X375050
		07.1992	06.1994	GIRL-TRW	1	38	10		X375129	X375130
		07.1992	06.1994	GIRL-TRW	1	43	20		X375023	X375024
		07.1992	06.1994	GIRL-TRW	1	43	20		X375131	X375132
2.0 E quattro		12.1990	07.1992	ATE	1	57	15		X224239	X224240
		12.1990	07.1992	GIRL-TRW	1	38	10		X375049	X375050
		12.1990	07.1992	GIRL-TRW	1	38	10		X375129	X375130
		12.1990	07.1992	GIRL-TRW	1	43	20		X375023	X375024
		12.1990	07.1992	GIRL-TRW	1	43	20		X375131	X375132
2.3 E		12.1990	06.1994	ATE	1	57	15		X224239	X224240
		12.1990	06.1994	GIRL-TRW	1	38	10		X375063	X375064
2.3 E quattro		12.1990	06.1994	ATE	1	57	15		X224239	X224240
		12.1990	06.1994	GIRL-TRW	1	38	10		X375049	X375050
		12.1990	06.1994	GIRL-TRW	1	38	10		X375129	X375130
2.4 D		12.1990	06.1994	ATE	1	57	15		X224239	X224240
2.5 TDI		12.1990	06.1994	ATE	1	57	15		X224239	X224240
		12.1990	06.1994	GIRL-TRW	1	38	10		X375063	X375064
2.6		03.1992	06.1994	ATE	1	57	25		X224241	X224242
		03.1992	06.1994	GIRL-TRW	1	38	10		X375063	X375064
2.6 E quattro		08.1993	07.1994	ATE	1	57	15		X224239	X224240
		08.1993	07.1994	GIRL-TRW	1	43	20		X375023	X375024
		08.1993	07.1994	GIRL-TRW	1	43	20		X375131	X375132
2.6 quattro		04.1992	06.1994	ATE	1	57	25		X224241	X224242
		04.1992	06.1994	GIRL-TRW	1	38	10		X375049	X375050
		04.1992	06.1994	GIRL-TRW	1	38	10		X375129	X375130
2.8 E		12.1990	06.1994	ATE	1	57	25		X224241	X224242
		12.1990	06.1994	GIRL-TRW	1	38	10/Ø245		X375063	X375064

X=1 : SNRA - X=2 : EAI - X=3 : SERA - X=4 : SEEAC - X=5 : NEOTO - X=6 : STARTCAR

Affectations par Marques

Vehicule application - Zuordnung nach Marke und Fahrzeuge - Applicazione per marca e veicolo - Aplicacion por marca y vehiculo



AUDI



100 (4A, C4)

2.8 E quattro		12.1990	06.1994	ATE	1	57	15		X224239	X224240
		12.1990	06.1994	GIRL-TRW	1	38	10		X375049	X375050
		12.1990	06.1994	GIRL-TRW	1	38	10		X375129	X375130
		09.1991	06.1994	GIRL-TRW	1	43	20		X375023	X375024
		09.1991	06.1994	GIRL-TRW	1	43	20		X375131	X375132

100 (C1)

Tout / All / Alle / Tutti / Todos		10.1970	07.1976	ATE	2	48	10,5		X224351	X224352
-----------------------------------	--	---------	---------	-----	---	----	------	--	---------	---------

200 (44, 44Q)

2.1 5E		08.1983	07.1984	GIRL-TRW	1	36	10		X375003	X375004
2.1 Turbo		08.1983	01.1988	GIRL-TRW	2	40/45	25		X374041	X374042
		08.1983	01.1988	GIRL-TRW	1	36	10		X375003	X375004
2.1 Turbo quattro		08.1983	01.1988	GIRL-TRW	2	40/45	25		X374041	X374042
		08.1983	09.1986	GIRL-TRW	1	36	10		X375021	X375022
		09.1983	01.1988	GIRL-TRW	1	43	20		X375023	X375024
		09.1983	01.1988	GIRL-TRW	1	43	20		X375131	X375132
2.2		08.1984	07.1985	GIRL-TRW	1	36	10		X375003	X375004
2.2 20V Turbo quattro		03.1989	12.1990	ATE	1	60	25		X224467	X224468
		03.1989	12.1990	GIRL-TRW	1	36	10		X375021	X375022
		07.1989	12.1990	GIRL-TRW	1	43	20		X375023	X375024
		07.1989	12.1990	GIRL-TRW	1	43	20		X375131	X375132
2.2 Turbo		08.1985	09.1991	ATE	1	60	25		X224469	X224470
		08.1985	09.1991	GIRL-TRW	2	40/45	25		X374041	X374042
		08.1985	12.1987	GIRL-TRW	1	36	10		X375003	X375004
		08.1985	09.1991	GIRL-TRW	1	38	10		X375063	X375064
2.2 Turbo quattro		09.1983	12.1991	ATE	1	60	25		X224469	X224470
		09.1983	12.1991	GIRL-TRW	2	40/45	25		X374041	X374042
		09.1983	01.1988	GIRL-TRW	1	43	20		X375023	X375024
		09.1983	01.1988	GIRL-TRW	1	43	20		X375131	X375132
		01.1985	01.1988	GIRL-TRW	1	36	10		X375021	X375022
2.3		11.1986	12.1987	ATE	1	60	25		X224469	X224470
		11.1986	12.1987	GIRL-TRW	2	40/45	25		X374041	X374042
		11.1986	12.1987	GIRL-TRW	1	38	10		X375063	X375064

A1 (8X1,, 8XK, 8XF)

Tout / All / Alle / Tutti / Todos		05.2010		ATE	1	54	22/Ø256 -280		X224455	X224456
		05.2010		ATE	1	54	25/Ø288 -312		X224619	X224620
		05.2010		GIRL-TRW	1	38	9/Ø232		X375275	X375276

A2 (8Z0)

1.2 TDI		03.2001	08.2005	ATE	-	48	15		X224631	X224632
1.4		02.2000	08.2005	ATE	1	54	22		X224455	X224456
1.4 TDI		02.2000	08.2005	ATE	1	54	22		X224455	X224456
1.6 FSI		05.2002	08.2005	ATE	1	54	22		X224455	X224456
Tout / All / Alle / Tutti / Todos		05.2002	08.2005	GIRL-TRW	1	34	9		X375299	X375300

X=1 : SNRA - X=2 : EAI - X=3 : SERA - X=4 : SEEC - X=5 : NEOTO - X=6 : STARTCAR

Affectations par Marques

Vehicule application - Zuordnung nach Marke und Fahrzeuge - Applicazione per marca e veicolo - Aplicacion por marca y vehiculo



AUDI



A3 (8L1)

1.6		09.1996	05.2003	ATE	1	54	22		X224455	X224456
		09.1996	06.1999	GIRL-TRW	1	38	9		X375143	X375144
		07.1999	05.2003	GIRL-TRW	1	38	9		X375275	X375276
1.8		09.1996	05.2003	ATE	1	54	22		X224455	X224456
		09.1996	06.1999	GIRL-TRW	1	38	9		X375143	X375144
		07.1999	05.2003	GIRL-TRW	1	38	9		X375275	X375276
1.8 T		12.1996	05.2003	ATE	1	54	25		X224249	X224250
		12.1996	06.1999	GIRL-TRW	1	38	9		X375143	X375144
		07.1999	05.2003	GIRL-TRW	1	38	9		X375275	X375276
1.8 T quattro		12.1996	05.2003	ATE	1	54	25		X224249	X224250
		12.1996	05.2003	GIRL-TRW	1	41	9		X375193	X375194
1.9 TDI		09.1996	05.2003	ATE	1	54	22		X224455	X224456
		08.2000	05.2003	ATE	1	54	25		X224249	X224250
		09.1996	06.1999	GIRL-TRW	1	38	9		X375143	X375144
		07.1999	05.2003	GIRL-TRW	1	38	9		X375275	X375276
1.9 TDI quattro		08.2000	05.2003	ATE	1	54	25		X224249	X224250
		08.2000	05.2003	GIRL-TRW	1	41	9		X375193	X375194

A3 (8P1)

1.2 TSI		04.2010	08.2012	ATE	1	54	22/Ø256-280		X224455	X224456
		04.2010	08.2012	ATE	1	54	25/Ø288-312		X224619	X224620
		04.2010	08.2012	ATE	1	57	25-30/Ø345		X224725	X224726
		04.2010	08.2012	ATE	1	57	30/Ø340		X224741	X224742
		04.2010	08.2012	BOSCH	1	38	10/Ø272		X275065	X275066
		04.2010	08.2012	GIRL-TRW	1	38	10/Ø253		X375293	X375294
		04.2010	08.2012	GIRL-TRW	1	38	12		X375377	X375378
1.4 TFSI		09.2007	08.2012	ATE	1	54	22/Ø256-280		X224455	X224456
		09.2007	08.2012	ATE	1	54	25/Ø288-312		X224619	X224620
		09.2007	08.2012	ATE	1	57	25-30/Ø345		X224725	X224726
		09.2007	08.2012	ATE	1	57	30/Ø340		X224741	X224742
		09.2007	08.2012	BOSCH	1	38	10/Ø272		X275065	X275066
		09.2007	08.2012	GIRL-TRW	1	38	10/Ø253		X375293	X375294
		09.2007	08.2012	GIRL-TRW	1	38	12/Ø282		X375377	X375378
1.6 / 1.6 FSI / 1.6 TDI		05.2003	08.2012	ATE	1	54	22/Ø256-280		X224455	X224456
		05.2003	08.2012	ATE	1	54	25/Ø288-312		X224619	X224620
		05.2003	08.2012	ATE	1	57	25-30/Ø345		X224725	X224726
		05.2003	08.2012	ATE	1	57	30/Ø340		X224741	X224742
		05.2003	08.2012	BOSCH	1	38	10/Ø272		X275065	X275066
		05.2003	08.2012	GIRL-TRW	1	38	10/Ø253		X375293	X375294
		05.2003	08.2012	GIRL-TRW	1	38	12/Ø282		X375377	X375378

Affectations par Marques

Vehicule application - Zuordnung nach Marke und Fahrzeuge - Applicazione per marca e veicolo - Aplicacion por marca y vehiculo



AUDI



A3 (8P1)

1.6 E-Power		01.2011	08.2012	ATE	1	54	22/Ø256 -280		X224455	X224456
		01.2011	08.2012	ATE	1	54	25/Ø288 -312		X224619	X224620
		01.2011	08.2012	ATE	1	57	25-30/Ø345		X224725	X224726
		01.2011	08.2012	ATE	1	57	30/Ø340		X224741	X224742
		01.2011	08.2012	BOSCH	1	38	10/Ø272		X275065	X275066
		01.2011	08.2012	GIRL-TRW	1	38	10/Ø253		X375293	X375294
		01.2011	08.2012	GIRL-TRW	1	38	12/Ø282		X375377	X375378
1.8 TFSI		11.2006	08.2012	ATE	1	54	22/Ø256 -280		X224455	X224456
		11.2006	08.2012	ATE	1	54	25/Ø288 -312		X224619	X224620
		11.2006	08.2012	ATE	1	57	25-30/Ø345		X224725	X224726
		11.2006	08.2012	ATE	1	57	30/Ø340		X224741	X224742
		11.2006	08.2012	BOSCH	1	38	10/Ø272		X275065	X275066
		11.2006	08.2012	GIRL-TRW	1	38	10/Ø253		X375293	X375294
		11.2006	08.2012	GIRL-TRW	1	38	12/Ø282		X375377	X375378
1.8 TFSI quattro		07.2008	08.2012	ATE	1	54	22/Ø256 -280		X224455	X224456
		07.2008	08.2012	ATE	1	54	25/Ø288 -312		X224619	X224620
		07.2008	08.2012	ATE	1	57	25-30/Ø345		X224725	X224726
		07.2008	08.2012	ATE	1	57	30/Ø340		X224741	X224742
		07.2008	08.2012	BOSCH	1	38	10/Ø272		X275065	X275066
		07.2008	08.2012	GIRL-TRW	1	41	12/Ø282		X375313	X375314
		07.2008	08.2012	GIRL-TRW	1	41	22		X375379	X375380
1.9 TDI		05.2003	05.2010	ATE	1	54	22/Ø256 -280		X224455	X224456
		05.2003	05.2010	ATE	1	54	25/Ø288 -312		X224619	X224620
		05.2003	05.2010	ATE	1	57	25-30/Ø345		X224725	X224726
		05.2003	05.2010	ATE	1	57	30/Ø340		X224741	X224742
		05.2003	05.2010	BOSCH	1	38	10/Ø272		X275065	X275066
		05.2003	05.2010	GIRL-TRW	1	38	10/Ø253		X375293	X375294
		05.2003	05.2010	GIRL-TRW	1	38	12/Ø282		X375377	X375378
2.0 FSI		05.2003	06.2008	ATE	1	54	22/Ø256 -280		X224455	X224456
		05.2003	06.2008	ATE	1	54	25/Ø288 -312		X224619	X224620
		05.2003	06.2008	ATE	1	57	25-30/Ø345		X224725	X224726
		05.2003	06.2008	ATE	1	57	30/Ø340		X224741	X224742
		05.2003	06.2008	BOSCH	1	38	10/Ø272		X275065	X275066
		05.2003	06.2008	GIRL-TRW	1	38	10/Ø253		X375293	X375294
		05.2003	06.2008	GIRL-TRW	1	38	12/Ø282		X375377	X375378
2.0 TDI		05.2003	08.2012	ATE	1	54	22/Ø256 -280		X224455	X224456
		05.2003	08.2012	ATE	1	54	25/Ø288 -312		X224619	X224620
		05.2003	08.2012	ATE	1	57	25-30/Ø345		X224725	X224726
		05.2003	08.2012	ATE	1	57	30/Ø340		X224741	X224742
		05.2003	08.2012	BOSCH	1	38	10/Ø272		X275065	X275066
		05.2003	08.2012	GIRL-TRW	1	38	10/Ø253		X375293	X375294
		05.2003	08.2012	GIRL-TRW	1	38	12/Ø282		X375377	X375378

Affectations par Marques

Vehicule application - Zuordnung nach Marke und Fahrzeuge - Applicazione per marca e veicolo - Aplicacion por marca y vehiculo



AUDI



A3 (8P1)

2.0 TDI 16V		05.2003	08.2012	ATE	1	54	22/Ø256 -280		X224455	X224456
		05.2003	08.2012	ATE	1	54	25/Ø288 -312		X224619	X224620
		05.2003	08.2012	ATE	1	57	25-30/Ø345		X224725	X224726
		05.2003	08.2012	ATE	1	57	30/Ø340		X224741	X224742
		05.2003	08.2012	BOSCH	1	38	10/Ø272		X275065	X275066
		05.2003	08.2012	GIRL-TRW	1	38	10/Ø253		X375293	X375294
		05.2003	08.2012	GIRL-TRW	1	38	12/Ø282		X375377	X375378
2.0 TDI 16V quattro		08.2004	08.2012	ATE	1	54	22/Ø256 -280		X224455	X224456
		08.2004	08.2012	ATE	1	54	25/Ø288 -312		X224619	X224620
		08.2004	08.2012	ATE	1	57	25-30/Ø345		X224725	X224726
		08.2004	08.2012	ATE	1	57	30/Ø340		X224741	X224742
		08.2004	08.2012	BOSCH	1	38	10/Ø272		X275065	X275066
		08.2004	08.2012	GIRL-TRW	1	41	12/Ø282		X375313	X375314
		08.2004	08.2012	GIRL-TRW	1	41	22		X375379	X375380
2.0 TDI quattro		01.2006	05.2007	ATE	1	54	22/Ø256 -280		X224455	X224456
		01.2006	05.2007	ATE	1	54	25/Ø288 -312		X224619	X224620
		01.2006	05.2007	ATE	1	57	25-30/Ø345		X224725	X224726
		01.2006	05.2007	ATE	1	57	30/Ø340		X224741	X224742
		01.2006	05.2007	GIRL-TRW	1	41	12/Ø282		X375313	X375314
		01.2006	05.2007	GIRL-TRW	1	41	22		X375379	X375380
		03.2006	08.2012	BOSCH	1	38	10/Ø272		X275065	X275066
2.0 TFSI		09.2004	08.2012	ATE	1	54	22/Ø256 -280		X224455	X224456
		09.2004	08.2012	ATE	1	54	25/Ø288 -312		X224619	X224620
		09.2004	08.2012	ATE	1	57	25-30/Ø345		X224725	X224726
		09.2004	08.2012	ATE	1	57	30/Ø340		X224741	X224742
		09.2004	08.2012	BOSCH	1	38	10/Ø272		X275065	X275066
		09.2004	08.2012	GIRL-TRW	1	38	10/Ø253		X375293	X375294
		09.2004	08.2012	GIRL-TRW	1	38	12/Ø282		X375377	X375378
2.0 TFSI quattro		09.2004	08.2012	ATE	1	54	22/Ø256 -280		X224455	X224456
		09.2004	08.2012	ATE	1	54	25/Ø288 -312		X224619	X224620
		09.2004	08.2012	ATE	1	57	25-30/Ø345		X224725	X224726
		09.2004	08.2012	ATE	1	57	30/Ø340		X224741	X224742
		09.2004	08.2012	BOSCH	1	38	10		X275065	X275066
		09.2004	08.2012	GIRL-TRW	1	41	12		X375313	X375314
		09.2004	08.2012	GIRL-TRW	1	41	22		X375379	X375380
3.2 V6 quattro		07.2003	05.2009	ATE	1	54	22/Ø256 -280		X224455	X224456
		07.2003	05.2009	ATE	1	54	25/Ø288 -312		X224619	X224620
		07.2003	05.2009	ATE	1	57	25-30/Ø345		X224725	X224726
		07.2003	05.2009	ATE	1	57	30/Ø340		X224741	X224742
		07.2003	05.2009	BOSCH	1	38	10		X275065	X275066
		07.2003	05.2009	GIRL-TRW	1	41	12		X375313	X375314
		07.2003	05.2009	GIRL-TRW	1	41	22		X375379	X375380

Affectations par Marques

Vehicule application - Zuordnung nach Marke und Fahrzeuge - Applicazione per marca e veicolo - Aplicacion por marca y vehiculo



AUDI



A3 (8P7)

Tout / All / Alle / Tutti / Todos		04.2008	05.2013	ATE	1	54	22/Ø256 -280		X224455	X224456
		04.2008	05.2013	ATE	1	54	25/Ø288 -312		X224619	X224620
		04.2008	05.2013	BOSCH	1	38	10/Ø272		X275065	X275066
		04.2008	05.2013	GIRL-TRW	1	38	10/Ø253		X375293	X375294
		04.2008	05.2013	GIRL-TRW	1	38	12/Ø282		X375377	X375378

A3 (8PA)

1.2 TSI		04.2010	03.2013	BOSCH	1	38	10/Ø272		X275065	X275066
		04.2010	03.2013	GIRL-TRW	1	38	10/Ø253		X375293	X375294
		04.2010	03.2013	GIRL-TRW	1	38	12/Ø282		X375377	X375378
1.4 TFSI		09.2007	03.2013	BOSCH	1	38	10/Ø272		X275065	X275066
		09.2007	03.2013	GIRL-TRW	1	38	10/Ø253		X375293	X375294
		09.2007	03.2013	GIRL-TRW	1	38	12/Ø282		X375377	X375378
1.6		09.2004	03.2013	BOSCH	1	38	10/Ø272		X275065	X275066
		09.2004	03.2013	GIRL-TRW	1	38	10/Ø253		X375293	X375294
		09.2004	03.2013	GIRL-TRW	1	38	12/Ø282		X375377	X375378
1.6 E-Power		01.2011	03.2013	BOSCH	1	38	10/Ø272		X275065	X275066
		01.2011	03.2013	GIRL-TRW	1	38	10/Ø253		X375293	X375294
		01.2011	03.2013	GIRL-TRW	1	38	12/Ø282		X375377	X375378
1.6 FSI		09.2004	09.2007	BOSCH	1	38	10/Ø272		X275065	X275066
		09.2004	09.2007	GIRL-TRW	1	38	10/Ø253		X375293	X375294
		09.2004	09.2007	GIRL-TRW	1	38	12/Ø282		X375377	X375378
1.6 TDI		05.2009	08.2012	BOSCH	1	38	10/Ø272		X275065	X275066
		05.2009	08.2012	GIRL-TRW	1	38	10/Ø253		X375293	X375294
		05.2009	08.2012	GIRL-TRW	1	38	12/Ø282		X375377	X375378
1.8 TFSI		11.2006	03.2013	BOSCH	1	38	10/Ø272		X275065	X275066
		11.2006	03.2013	GIRL-TRW	1	38	10/Ø253		X375293	X375294
		11.2006	03.2013	GIRL-TRW	1	38	12/Ø282		X375377	X375378
1.8 TFSI quattro		07.2008	03.2013	BOSCH	1	38	10		X275065	X275066
		07.2008	03.2013	GIRL-TRW	1	41	12		X375313	X375314
		07.2008	03.2013	GIRL-TRW	1	41	22		X375379	X375380
1.9 TDI		09.2004	05.2010	BOSCH	1	38	10/Ø272		X275065	X275066
		09.2004	05.2010	GIRL-TRW	1	38	10/Ø253		X375293	X375294
		09.2004	05.2010	GIRL-TRW	1	38	12/Ø282		X375377	X375378
2.0 FSI		09.2004	06.2008	BOSCH	1	38	10/Ø272		X275065	X275066
		09.2004	06.2008	GIRL-TRW	1	38	10/Ø253		X375293	X375294
		09.2004	06.2008	GIRL-TRW	1	38	12/Ø282		X375377	X375378
2.0 TDI		09.2004	03.2013	BOSCH	1	38	10/Ø272		X275065	X275066
		09.2004	03.2013	GIRL-TRW	1	38	10/Ø253		X375293	X375294
		09.2004	03.2013	GIRL-TRW	1	38	12/Ø282		X375377	X375378
2.0 TDI 16V		09.2004	03.2013	BOSCH	1	38	10/Ø272		X275065	X275066
		09.2004	03.2013	GIRL-TRW	1	38	10/Ø253		X375293	X375294
		09.2004	03.2013	GIRL-TRW	1	38	12/Ø282		X375377	X375378

X=1 : SNRA - X=2 : EAI - X=3 : SERA - X=4 : SEEAC - X=5 : NEOTO - X=6 : STARTCAR

Affectations par Marques

Vehicule application - Zuordnung nach Marke und Fahrzeuge - Applicazione per marca e veicolo - Aplicacion por marca y vehiculo



AUDI



A3 (8PA)

2.0 TDI 16V quattro		11.2005	03.2013	BOSCH	1	38	10		X275065	X275066
		11.2005	03.2013	GIRL-TRW	1	41	12		X375313	X375314
		11.2005	03.2013	GIRL-TRW	1	41	22		X375379	X375380
2.0 TDI quattro		01.2006	03.2013	GIRL-TRW	1	41	12		X375313	X375314
		01.2006	03.2013	GIRL-TRW	1	41	22		X375379	X375380
		03.2006	03.2013	BOSCH	1	38	10		X275065	X275066
2.0 TFSI		09.2004	03.2013	BOSCH	1	38	10/Ø272		X275065	X275066
		09.2004	03.2013	GIRL-TRW	1	38	10/Ø253		X375293	X375294
		09.2004	03.2013	GIRL-TRW	1	38	12/Ø282		X375377	X375378
2.0 TFSI quattro		09.2004	03.2013	BOSCH	1	38	10		X275065	X275066
		09.2004	03.2013	GIRL-TRW	1	41	12		X375313	X375314
		09.2004	03.2013	GIRL-TRW	1	41	22		X375379	X375380
3.2 V6 quattro		09.2004	05.2009	BOSCH	1	38	10		X275065	X275066
		09.2004	05.2009	GIRL-TRW	1	41	12		X375313	X375314
		09.2004	05.2009	GIRL-TRW	1	41	22		X375379	X375380
Tout / All / Alle / Tutti / Todos		09.2004	03.2013	ATE	1	54	22/Ø256 -280		X224455	X224456
		09.2004	03.2013	ATE	1	54	25/Ø288 -312		X224619	X224620
		09.2004	03.2013	ATE	1	57	25-30/Ø345		X224725	X224726
		09.2004	03.2013	ATE	1	57	30/Ø340		X224741	X224742

A3 (8V)

Tout / All / Alle / Tutti / Todos		04.2012		GIRL-TRW	1	57	25/Ø288		X374777	X374778
		04.2012		GIRL-TRW	1	57	25/Ø312		X374759	X374760
		04.2012		GIRL-TRW	1	60	30/Ø340		X374781	X374782
		04.2012		ATE	1	38	10/Ø272		X227001	X227002
		04.2012		ATE	1	42	22/Ø310		X227005	X227006

A4 (8D2,8D5, B5)

Tout / All / Alle / Tutti / Todos		11.1994	11.2000	ATE	1	57	15		X224435	X224436
		11.1994	11.2000	ATE	1	57	25/Ø288 -312		X224433	X224434
		11.1994	11.2000	GIRL-TRW	1	54	13		X374383	X374384
		11.1994	11.2000	GIRL-TRW	1	54	22		X374435	X374436
		11.1994	02.1997	GIRL-TRW	1	38	10	Fe	X375085	X375086
		03.1997	11.2000	GIRL-TRW	1	38	10/Ø245	Al	X375165	X375166
Tout / All / Alle / Tutti / Todos (Quattro)		01.1995	11.2000	GIRL-TRW	1	38	10	Fe	X375087	X375088
		01.1995	11.2000	GIRL-TRW	1	43	10	Al	X375415	X375416

A4 (8E2, 8E5, B6)

Tout / All / Alle / Tutti / Todos		11.2000	12.2004	ATE	1	57	25/Ø288 -312		X224433	X224434
		11.2000	12.2004	ATE	1	57	25/Ø288 -312		X224833	X224834
		11.2000	12.2004	GIRL-TRW	1	54	22		X374435	X374436
		11.2000	12.2004	GIRL-TRW	1	38	10		X375251	X375252

Affectations par Marques

Vehicule application - Zuordnung nach Marke und Fahrzeuge - Applicazione per marca e veicolo - Aplicacion por marca y vehiculo



AUDI

A4 (8EC, 8ED, B7)

Tout / All / Alle / Tutti / Todos		11.2004	06.2008	ATE	1	57	25/Ø288-312		X224433	X224434
		11.2004	06.2008	ATE	1	57	25/Ø288-312		X224833	X224834
		11.2004	06.2008	ATE	1	60	30/Ø321		X224749	X224750
		11.2004	06.2008	GIRL-TRW	1	54	22		X374435	X374436
		11.2004	06.2008	GIRL-TRW	1	38	10		X375251	X375252
		11.2004	06.2008	GIRL-TRW	1	41	12		X375389	X375390

A4 (8H7, B6, 8HE, B7)

Tout / All / Alle / Tutti / Todos		04.2002	12.2005	ATE	1	57	25/Ø288-312		X224433	X224434
		04.2002	03.2009	ATE	1	60	30/Ø321		X224749	X224750
		01.2006	03.2009	ATE	1	57	25/Ø288-312		X224833	X224834
		04.2002	03.2009	GIRL-TRW	1	38	10		X375251	X375252
		04.2002	03.2009	GIRL-TRW	1	41	12		X375389	X375390

A4 (8K2, 8K5, B8)

Tout / All / Alle / Tutti / Todos		11.2007	12.2012	ATE	1	57	25		X224785	X224786
		11.2007	12.2012	GIRL-TRW	1	57	30/Ø320		X374675	X374676
		11.2007	12.2012	GIRL-TRW	1	57	30/Ø345		X374717	X374718
		11.2007	12.2012	GIRL-TRW	1	43	12		X377027	X377028

A4 (8KH, B8)

Tout / All / Alle / Tutti / Todos		04.2009	12.2015	ATE	1	57	25		X224785	X224786
		04.2009	12.2015	GIRL-TRW	1	57	30/Ø320		X374675	X374676
		04.2009	12.2015	GIRL-TRW	1	57	30/Ø345		X374717	X374718
		04.2009	12.2015	GIRL-TRW	1	43	12		X377027	X377028

A5 (8F7/8T3/8TA)

Tout / All / Alle / Tutti / Todos		06.2007		ATE	1	57	25		X224785	X224786
		06.2007		GIRL-TRW	1	57	30/Ø320		X374675	X374676
		06.2007		GIRL-TRW	1	57	30/Ø345		X374717	X374718
		06.2007		GIRL-TRW	1	43	12		X377027	X377028

A6 (4A, C4)

Tout / All / Alle / Tutti / Todos		06.1994	10.1997	ATE	1	57	15		X224239	X224240
		06.1994	10.1997	ATE	1	57	25		X224241	X224242
		06.1994	10.1997	GIRL-TRW	1	38	10/Ø245		X375063	X375064
Tout / All / Alle / Tutti / Todos (Quattro)		06.1994	10.1997	GIRL-TRW	1	38	10		X375049	X375050
		06.1994	10.1997	GIRL-TRW	1	38	10		X375129	X375130

A6 (4B2, C5)

1.8		01.1997	01.2005	ATE	1	57	25/Ø288-312		X224433	X224434
		01.1997	01.2005	ATE	1	57	25/Ø288-312		X224833	X224834
1.8 T		01.1997	01.2005	ATE	1	57	25/Ø288-312		X224433	X224434
		01.1997	01.2005	ATE	1	57	25/Ø288-312		X224833	X224834
		01.1997	01.2005	ATE	1	60	30		X224887	X224888

Affectations par Marques

Vehicule application - Zuordnung nach Marke und Fahrzeuge - Applicazione per marca e veicolo - Aplicacion por marca y vehiculo



AUDI



A6 (4B2, C5)

1.8 T quattro		01.1997	10.2000	ATE	1	57	25/Ø288-312		X224433	X224434
		01.1997	10.2000	ATE	1	57	25/Ø288-312		X224833	X224834
		01.1997	01.2005	ATE	1	60	30		X224887	X224888
		01.1997	10.2000	GIRL-TRW	2	43	30/Ø321		X374609	X374610
1.9 TDI		01.1997	04.2001	ATE	1	57	25/Ø288-312		X224433	X224434
		01.1997	04.2001	ATE	1	57	25/Ø288-312		X224833	X224834
		01.1997	01.2005	ATE	1	60	30		X224887	X224888
2.0		01.1997	05.2004	ATE	1	57	25/Ø288-312		X224433	X224434
		01.1997	05.2004	ATE	1	57	25/Ø288-312		X224833	X224834
		01.1997	05.2004	ATE	1	60	30		X224887	X224888
2.4		01.1997	09.2001	ATE	1	57	25/Ø288-312		X224433	X224434
		01.1997	09.2001	ATE	1	57	25/Ø288-312		X224833	X224834
		01.1997	05.2004	ATE	1	60	30		X224887	X224888
2.4 quattro		01.1997	01.2005	ATE	1	57	25/Ø288-312		X224433	X224434
		01.1997	01.2005	ATE	1	57	25/Ø288-312		X224833	X224834
		01.1997	05.2004	ATE	1	60	30		X224887	X224888
		01.1997	07.1999	GIRL-TRW	2	43	30	->4BX060000	X374757	X374758
		08.1999	01.2005	GIRL-TRW	2	43	30/Ø321	4BX060001->	X374609	X374610
2.5 TDI		01.1997	04.2001	ATE	1	57	25/Ø288-312		X224433	X224434
		01.1997	04.2001	ATE	1	57	25/Ø288-312		X224833	X224834
		01.1997	05.2004	ATE	1	60	30		X224887	X224888
2.5 TDI quattro		01.1997	05.2001	ATE	1	57	25/Ø288-312		X224433	X224434
		01.1997	05.2001	ATE	1	57	25/Ø288-312		X224833	X224834
		01.1997	05.2004	ATE	1	60	30		X224887	X224888
		01.1997	05.2001	GIRL-TRW	2	43	30/Ø321		X374609	X374610
2.7 quattro		01.1997	07.2004	ATE	1	57	25/Ø288-312		X224433	X224434
2.7 T		01.1997	08.2000	GIRL-TRW	2	43	30/Ø321		X374609	X374610
2.7 T quattro		01.1997	01.2005	ATE	1	57	25/Ø288-312		X224433	X224434
		01.1997	01.2005	ATE	1	57	25/Ø288-312		X224833	X224834
		01.1997	01.2005	GIRL-TRW	2	43	30/Ø321		X374609	X374610
2.8		01.1997	01.2005	ATE	1	57	25/Ø288-312		X224433	X224434
		01.1997	01.2005	ATE	1	57	25/Ø288-312		X224833	X224834
2.8 quattro		01.1997	05.2001	ATE	1	57	25/Ø288-312		X224433	X224434
		01.1997	05.2001	ATE	1	57	25/Ø288-312		X224833	X224834
		01.1997	05.2001	GIRL-TRW	2	43	30/Ø321		X374609	X374610
3.0		01.1997	07.2004	ATE	1	57	25/Ø288-312		X224433	X224434
		01.1997	07.2004	ATE	1	57	25/Ø288-312		X224833	X224834
		01.1997	07.2004	ATE	1	60	30		X224887	X224888
3.0 quattro		01.1997	01.2005	ATE	1	57	25/Ø288-312		X224433	X224434
		01.1997	01.2005	ATE	1	57	25/Ø288-312		X224833	X224834
		01.1997	01.2005	ATE	1	60	30		X224887	X224888

Affectations par Marques

Vehicule application - Zuordnung nach Marke und Fahrzeuge - Applicazione per marca e veicolo - Aplicacion por marca y vehiculo



AUDI



A6 (4B2, C5)

4.2 quattro		01.1997	01.2005	ATE	1	57	25/Ø288-312		X224433	X224434
		01.1997	01.2005	ATE	1	57	25/Ø288-312		X224833	X224834
		01.1997	01.2005	ATE	1	60	30		X224887	X224888
		01.1997	01.2005	GIRL-TRW	2	43	30/Ø321		X374609	X374610
Tout / All / Alle / Tutti / Todos		01.1997	01.2005	GIRL-TRW	1	38	10/Ø245		X375165	X375166
		01.1997	01.2005	GIRL-TRW	1	43	22		X375309	X375310
Tout / All / Alle / Tutti / Todos (Quattro)		01.1997	01.2005	GIRL-TRW	1	38	10		X375203	X375204
		01.1997	01.2005	GIRL-TRW	1	43	22		X375309	X375310

A6 (4B5, C5)

Tout / All / Alle / Tutti / Todos		12.1997	01.2005	ATE	1	57	25/Ø288-312		X224433	X224434
		12.1997	01.2005	ATE	1	57	25/Ø288-312		X224833	X224834
		12.1997	01.2005	ATE	1	60	30		X224887	X224888
		12.1997	01.2005	GIRL-TRW	2	43	30/Ø321		X374609	X374610
		12.1997	01.2005	GIRL-TRW	1	38	10/Ø245		X375165	X375166
		12.1997	01.2005	GIRL-TRW	1	43	22		X375309	X375310
Tout / All / Alle / Tutti / Todos (Quattro)		12.1997	01.2005	GIRL-TRW	1	38	10		X375203	X375204
		12.1997	01.2005	GIRL-TRW	1	43	22		X375309	X375310

A6 (4F2, 4F5, C6)

Tout / All / Alle / Tutti / Todos		05.2004	08.2011	ATE	1	57	25/Ø288-312		X224433	X224434
		05.2004	08.2011	ATE	1	57	25/Ø288-312		X224833	X224834
		05.2004	08.2011	ATE	1	60	30/Ø321		X224749	X224750
		05.2004	08.2011	ATE	1	60	30/Ø345		X224651	X224652
		05.2004	08.2011	ATE	2	42	34/Ø360		X224737	X224738
		05.2004	08.2011	GIRL-TRW	1	41	12		X377013	X377014
		05.2004	08.2011	GIRL-TRW	1	41	12		X377007	X377008
		05.2004	08.2011	GIRL-TRW	1	43	22		X377025	X377026

A6 (4FH, C6)

Tout / All / Alle / Tutti / Todos		05.2006	08.2011	ATE	1	60	30/Ø321		X224749	X224750
		05.2006	08.2011	ATE	1	60	30/Ø345		X224651	X224652
		05.2006	08.2011	GIRL-TRW	1	41	12		X377013	X377014
		05.2006	08.2011	GIRL-TRW	1	41	12		X377007	X377008
		05.2006	08.2011	GIRL-TRW	1	43	22		X377025	X377026

A6 (4G2, 4G5, C7)

Tout / All / Alle / Tutti / Todos		11.2010		ATE	2	42	34/Ø356		X224857	X224858
		11.2010		GIRL-TRW	1	60	30/Ø320		X374733	X374734
		11.2010		GIRL-TRW	1	60	30/Ø345		X374735	X374736
		11.2010		GIRL-TRW	1	43	12/Ø300		X377043	X377044
		11.2010		GIRL-TRW	1	43	22/Ø330		X377045	X377046
		11.2010		GIRL-TRW	1	43	30/Ø370		X377049	X377050

A6 (4GC, 4GD, C7)

Tout / All / Alle / Tutti / Todos		05.2014		ATE	2	42	34/Ø356		X224857	X224858
		05.2014		GIRL-TRW	1	43	22/Ø330		X377045	X377046

X=1 : SNRA - X=2 : EAI - X=3 : SERA - X=4 : SEEC - X=5 : NEOTO - X=6 : STARTCAR

Affectations par Marques

Vehicule application - Zuordnung nach Marke und Fahrzeuge - Applicazione per marca e veicolo - Aplicacion por marca y vehiculo



AUDI



A6 (4GH)

3.0 TDI/TFSI quattro		01.2012	12.2014	ATE	2	42	34/Ø356		X224857	X224858
		01.2012	12.2014	GIRL-TRW	1	60	30/Ø345		X374735	X374736
		01.2012	12.2014	GIRL-TRW	1	43	22/Ø330		X377045	X377046

A6 (4GJ)

Tout / All / Alle / Tutti / Todos		01.2012		ATE	2	42	34/Ø356		X224857	X224858
		01.2012		GIRL-TRW	1	43	22/Ø330		X377045	X377046

A7 (4GA, 4GF)

Tout / All / Alle / Tutti / Todos		10.2010		ATE	2	42	34/Ø356		X224857	X224858
		10.2010		GIRL-TRW	1	60	30/Ø320		X374733	X374734
		10.2010		GIRL-TRW	1	43	12/Ø300		X377043	X377044
		10.2010		GIRL-TRW	1	43	22/Ø330		X377045	X377046

A8 (4D2, 4D8)

2.5 TDI		01.1997	04.2000	GIRL-TRW	2	43	30		X374407	X374408
		01.1997	09.2002	GIRL-TRW	2	43	30/Ø321		X374609	X374610
		09.2000	09.2002	GIRL-TRW	2	43	30		X374757	X374758
		01.1997	09.2002	GIRL-TRW	1	38	10		X375049	X375050
		01.1997	09.2002	GIRL-TRW	1	38	10		X375129	X375130
2.5 TDI quattro		07.1997	04.2000	GIRL-TRW	2	43	30		X374651	X374652
		07.1997	12.1998	GIRL-TRW	2	43	30		X374407	X374408
		07.1997	04.2000	GIRL-TRW	2	43	30/Ø321		X374609	X374610
		09.2000	09.2002	ATE	2	42	34/Ø360		X224737	X224738
		09.2000	09.2002	GIRL-TRW	1	43	22	Alu.	X375189	X375190
2.8		03.1994	09.2002	GIRL-TRW	2	43	30		X374407	X374408
		04.1996	09.2002	GIRL-TRW	2	43	30/Ø321		X374609	X374610
		04.1996	09.2002	GIRL-TRW	1	43	20	Fonte	X375139	X375140
2.8 quattro		03.1994	09.2002	GIRL-TRW	2	43	30		X374407	X374408
		04.1996	09.2002	GIRL-TRW	2	43	30		X374651	X374652
		04.1996	10.1998	GIRL-TRW	1	43	20	Fonte	X375139	X375140
		11.1998	09.2002	GIRL-TRW	1	43	22	Alu.	X375189	X375190
3.3 TDI quattro		06.2000	09.2002	ATE	2	42	34/Ø360		X224737	X224738
		06.2000	09.2002	GIRL-TRW	1	43	22	Alu.	X375189	X375190
3.7		07.1995	12.1998	GIRL-TRW	2	43	30		X374407	X374408
		11.1998	09.2002	GIRL-TRW	2	43	30		X374651	X374652
		11.1998	09.2002	GIRL-TRW	2	43	30/Ø321		X374609	X374610
		07.1995	11.1998	GIRL-TRW	1	43	20	Fonte	X375139	X375140
		12.1998	09.2002	GIRL-TRW	1	43	22	Alu.	X375189	X375190
3.7 quattro		07.1995	11.1998	GIRL-TRW	2	43	30		X374651	X374652
		07.1995	12.1998	GIRL-TRW	2	43	30		X374407	X374408
		11.1998	09.2002	GIRL-TRW	2	43	30/Ø321		X374609	X374610
		07.1995	11.1998	GIRL-TRW	1	43	20	Fonte	X375139	X375140
		12.1998	09.2002	GIRL-TRW	1	43	22	Alu.	X375189	X375190

Affectations par Marques

Vehicule application - Zuordnung nach Marke und Fahrzeuge - Applicazione per marca e veicolo - Aplicacion por marca y vehiculo



AUDI



A8 (4D2, 4D8)

4.2 quattro		03.1994	09.2002	GIRL-TRW	2	43	30		X374407	X374408	
		11.1998	09.2002	GIRL-TRW	2	43	30/Ø321		X374609	X374610	
		02.1999	04.2000	GIRL-TRW	2	43	30		X374651	X374652	
		03.1994	11.1998	GIRL-TRW	1	43	20		Fonte	X375139	X375140
		12.1998	09.2002	GIRL-TRW	1	43	22		Alu.	X375189	X375190
6.0 W12 quattro		01.2001	09.2002	ATE	2	42	34/Ø360			X224737	X224738
		01.2001	09.2002	GIRL-TRW	1	43	22		Alu.	X375189	X375190

A8 (4E_)

Tout / All / Alle / Tutti / Todos		05.2003	07.2010	ATE	1	60	30/Ø321			X224749	X224750
		05.2003	07.2010	ATE	1	60	30/Ø323			X224907	X224908
		08.2007	07.2010	ATE	2	42	34/Ø360			X224737	X224738
		05.2003	07.2010	GIRL-TRW	1	45				X377053	X377054
		05.2003	07.2010	GIRL-TRW	1	43	22/Ø280			X377023	X377024
		05.2003	07.2010	GIRL-TRW	1	43	22/Ø336			X377017	X377018

A8 (4H_)

Tout / All / Alle / Tutti / Todos		11.2009		ATE	2	42	34/Ø356			X224857	X224858
		11.2009		GIRL-TRW	1	43				X377051	X377052
		11.2009		GIRL-TRW	1	43	22			X377067	X377068

ALLROAD (4BH, C5)

Tout / All / Alle / Tutti / Todos		05.2000	08.2005	ATE	1	60	30			X224887	X224888
		05.2000	08.2005	GIRL-TRW	2	43	30/Ø321			X374609	X374610
		05.2000	08.2005	GIRL-TRW	1	38	10			X375203	X375204
		05.2000	08.2005	GIRL-TRW	1	43	22			X375309	X375310

CABRIOLET (8G7, B4)

1.8		01.1997	08.2000	GIRL-TRW	1	38	10/Ø245	#ID: 4060 4061		X375063	X375064
1.9 TDI		06.1995	08.2000	GIRL-TRW	1	38	10/Ø245	#ID: 4060 4061		X375063	X375064
2.0 16V		06.1995	07.1996	GIRL-TRW	1	38	10/Ø245	#ID: 4060 4061		X375063	X375064
2.0 E		01.1993	07.1998	GIRL-TRW	1	38	10/Ø245	#ID: 4060 4061		X375063	X375064
2.3 E		05.1991	07.1994	GIRL-TRW	1	38	10/Ø245	#ID: 2618 2619		X375005	X375006
		05.1991	07.1994	GIRL-TRW	1	38	10/Ø245	#ID: 4060 4061		X375063	X375064
2.6		06.1993	08.2000	GIRL-TRW	1	38	10/Ø245	#ID: 4060 4061		X375063	X375064
		06.1993	08.2000	GIRL-TRW	1	38	10/Ø245	#ID: 460 461		X375047	X375048
2.8		11.1992	08.2000	GIRL-TRW	2	40/45	25			X374361	X374362
		11.1992	08.2000	GIRL-TRW	1	38	10/Ø245	#ID: 4060 4061		X375063	X375064
		11.1992	08.2000	GIRL-TRW	1	38	10/Ø245	#ID: 460 461		X375047	X375048
Tout / All / Alle / Tutti / Todos		01.1993	08.2000	ATE	1	54	22			X224181	X224182
		01.1993	08.2000	GIRL-TRW	1	54	22			X374359	X374360

COUPE (81, 85)

1.6		07.1980	08.1981	GIRL-TRW	1	48	12			X374081	X374082
1.8 GT		09.1982	10.1988	GIRL-TRW	1	48	12			X374081	X374082

Affectations par Marques

Vehicule application - Zuordnung nach Marke und Fahrzeuge - Applicazione per marca e veicolo - Aplicacion por marca y vehiculo



AUDI



COUPE (81, 85)

1.8 GT quattro		12.1984	10.1988	ATE	1	54	22		X224181	X224182
		12.1984	10.1988	GIRL-TRW	1	54	22		X374133	X374134
		12.1984	10.1988	GIRL-TRW	1	38	10/Ø245	#ID: 2618 2619	X375005	X375006
		12.1984	10.1988	GIRL-TRW	1	38	10/Ø245	#ID: 4060 4061	X375063	X375064
1.9		08.1980	07.1983	GIRL-TRW	1	48	12		X374081	X374082
2.0		09.1983	07.1984	GIRL-TRW	1	48	12		X374081	X374082
		09.1983	04.1988	GIRL-TRW	1	54	13		X374037	X374038
2.1 GT		01.1981	08.1984	GIRL-TRW	1	48	12		X374081	X374082
		01.1981	08.1984	GIRL-TRW	1	36	10		X375003	X375004
2.2 GT		07.1981	10.1988	GIRL-TRW	1	54	13		X374037	X374038
		07.1981	10.1988	GIRL-TRW	1	36	10		X375003	X375004
2.2 quattro		10.1984	10.1988	GIRL-TRW	1	54	13		X374037	X374038
		10.1984	10.1988	GIRL-TRW	1	36	10		X375021	X375022
2.3 quattro		01.1987	10.1988	GIRL-TRW	1	54	13		X374037	X374038
		01.1987	10.1988	GIRL-TRW	1	36	10		X375021	X375022

COUPE (89, 8B)

1.8		08.1989	07.1991	ATE	1	54	22		X224181	X224182
2.0		05.1989	12.1996	ATE	1	54	22		X224181	X224182
		05.1989	12.1996	GIRL-TRW	1	54	22		X374359	X374360
2.0 16 V		01.1992	07.1994	ATE	1	54	22		X224181	X224182
		08.1992	12.1996	GIRL-TRW	1	54	22		X374359	X374360
2.0 20 V		08.1989	07.1991	ATE	1	54	22		X224181	X224182
2.0 20 V quattro		08.1989	07.1991	GIRL-TRW	2	40/45	25		X374361	X374362
2.2 quattro		11.1988	07.1991	ATE	1	54	22		X224181	X224182
		11.1988	07.1991	GIRL-TRW	1	54	22		X374359	X374360
2.3		10.1988	12.1996	ATE	1	54	22		X224181	X224182
2.3 20V quattro		11.1988	07.1991	GIRL-TRW	2	40/45	25		X374361	X374362
2.3 quattro		11.1988	12.1996	ATE	1	54	22		X224181	X224182
		11.1988	12.1996	GIRL-TRW	1	54	22		X374359	X374360
2.6		08.1992	12.1996	GIRL-TRW	1	54	22		X374359	X374360
		08.1992	07.1994	GIRL-TRW	2	40/45	25		X374361	X374362
2.6 quattro		08.1992	04.1995	ATE	1	54	22		X224181	X224182
		08.1992	04.1995	GIRL-TRW	1	54	22		X374359	X374360
2.8		09.1991	05.1996	GIRL-TRW	2	40/45	25		X374361	X374362
2.8 quattro		08.1991	12.1996	GIRL-TRW	2	40/45	25		X374361	X374362
S2 quattro		09.1990	12.1996	GIRL-TRW	2	40/45	25		X374361	X374362
Tout / All / Alle / Tutti / Todos		05.1989	12.1996	GIRL-TRW	1	38	10/Ø245	#ID: 2618 2619	X375005	X375006
		05.1989	12.1996	GIRL-TRW	1	38	10/Ø245	#ID: 4060 4061	X375063	X375064
Tout / All / Alle / Tutti / Todos (Quattro)		05.1989	12.1996	GIRL-TRW	1	38	10		X375049	X375050

Q3 (8U)

Tout / All / Alle / Tutti / Todos		06.2011		ATE	1	57	25		X224819	X224820
		06.2011		GIRL-TRW	1	38	12		X377001	X377002

X=1 : SNRA - X=2 : EAI - X=3 : SERA - X=4 : SEEAC - X=5 : NEOTO - X=6 : STARTCAR

Affectations par Marques

Vehicule application - Zuordnung nach Marke und Fahrzeuge - Applicazione per marca e veicolo - Aplicacion por marca y vehiculo



AUDI



Q5 (8R)

Tout / All / Alle / Tutti / Todos		11.2008		GIRL-TRW	1	60	30/Ø345		X374735	X374736
		11.2008		GIRL-TRW	1	43	12		X377027	X377028
		11.2008		GIRL-TRW	1	43	22/Ø330		X377063	X377064

Q7 (4L)

Tout / All / Alle / Tutti / Todos		03.2006		BREMBO	6	30/ 34/ 38	34		X284089	X284090
		03.2006	08.2015	BREMBO	4	28/30	28/Ø330		X285063	X285064
		03.2006	12.2009	BREMBO	4	28/32	28/Ø358		X285095	X285096
		03.2006	08.2015	BREMBO	4	28/32	30/Ø370		X285109	X285110
		01.2010	08.2015	BREMBO	4	30	28/Ø358		X285073	X285074

QUATTRO (85)

Tout / All / Alle / Tutti / Todos		07.1980	07.1991	GIRL-TRW	1	54	22		X374133	X374134
		07.1980	07.1991	GIRL-TRW	1	36	10		X375021	X375022
		07.1980	07.1991	GIRL-TRW	1	43	20		X375023	X375024
		07.1980	07.1991	GIRL-TRW	1	43	20		X375131	X375132

RS3 (8PA)

RS3 quattro		01.2011	12.2012	GIRL-TRW	1	41	22		X375379	X375380
-------------	--	---------	---------	----------	---	----	----	--	---------	---------

RS4 (8EC, B7)

RS4 quattro		09.2005	06.2008	GIRL-TRW	1	43	10/Ø245		X375487	X375488
-------------	--	---------	---------	----------	---	----	---------	--	---------	---------

RS4 (8ED, B7)

RS4 quattro		09.2005	06.2008	GIRL-TRW	1	43	10/Ø245		X375487	X375488
-------------	--	---------	---------	----------	---	----	---------	--	---------	---------

RS4 (8H7, B6, 8HE, B7)

RS4 quattro		06.2006	03.2009	GIRL-TRW	1	43	10/Ø245		X375487	X375488
-------------	--	---------	---------	----------	---	----	---------	--	---------	---------

RS5 (8F7/8T3/8TA)

RS5 quattro		03.2010		ATE	1	57	25		X224785	X224786
		03.2010		GIRL-TRW	1	57	30/Ø320		X374675	X374676
		03.2010		GIRL-TRW	1	57	30/Ø345		X374717	X374718
		03.2010		GIRL-TRW	1	43	22/Ø330		X377063	X377064

RS6 (4F2, C6)

RS6 quattro		09.2008	08.2010	GIRL-TRW	1	45	28/Ø356		X377057	X377058
-------------	--	---------	---------	----------	---	----	---------	--	---------	---------

RS6 (4F5, C6)

RS6 quattro		04.2008	08.2010	GIRL-TRW	1	45	28/Ø356		X377057	X377058
-------------	--	---------	---------	----------	---	----	---------	--	---------	---------

RS6 (4G5, C7)

RS6 quattro		01.2013		GIRL-TRW	1	43	22/Ø356		X377047	X377048
		01.2013		GIRL-TRW	1	43	30/Ø370		X377049	X377050

RS7 (4GA)

RS7 quattro		10.2013		GIRL-TRW	1	43	22/Ø356		X377047	X377048
		10.2013		GIRL-TRW	1	43	30/Ø370		X377049	X377050











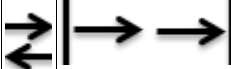



































S2 (8C, B4)

S2 quattro		02.1993	07.1995	GIRL-TRW	2	40/45	25		X374361	X374362
		02.1993	07.1995	GIRL-TRW	1	38	10		X375051	X375052

X=1 : SNRA - X=2 : EAI - X=3 : SERA - X=4 : SEEC - X=5 : NEOTO - X=6 : STARTCAR

Affectations par Marques

Vehicule application - Zuordnung nach Marke und Fahrzeuge - Applicazione per marca e veicolo - Aplicacion por marca y vehiculo

										
 AUDI 										
S3 (8L1)										
S3 quattro		03.1999	05.2003	ATE	1	54	25/Ø288 -312	X224249	X224250	
		03.1999	05.2003	GIRL-TRW	1	38	22	X375255	X375256	
S3 (8P1)										
S3 quattro		11.2006	08.2012	ATE	1	54	22/Ø256 -280	X224455	X224456	
		11.2006	08.2012	ATE	1	54	25/Ø288 -312	X224619	X224620	
		11.2006	08.2012	ATE	1	57	25-30/Ø345	X224725	X224726	
		11.2006	08.2012	ATE	1	57	30/Ø340	X224741	X224742	
		11.2006	08.2012	BOSCH	1	38	10	X275065	X275066	
		11.2006	08.2012	GIRL-TRW	1	41	12	X375313	X375314	
		11.2006	08.2012	GIRL-TRW	1	41	22	X375379	X375380	
S3 (8PA)										
S3 quattro		06.2008	03.2013	BOSCH	1	38	10	X275065	X275066	
		06.2008	03.2013	GIRL-TRW	1	41	12	X375313	X375314	
		06.2008	03.2013	GIRL-TRW	1	41	22	X375379	X375380	
S4 (4A, C4)										
S4 Turbo quattro		08.1991	06.1994	ATE	1	60	25	X224467	X224468	
		08.1991	06.1994	GIRL-TRW	2	43	30	X374385	X374386	
		08.1991	06.1994	GIRL-TRW	1	38	10		X375049	X375050
		08.1991	06.1994	GIRL-TRW	1	38	10		X375129	X375130
		09.1991	06.1994	GIRL-TRW	1	43	20		X375023	X375024
		09.1991	06.1994	GIRL-TRW	1	43	20		X375131	X375132
S4 V8 quattro		10.1992	06.1994	ATE	1	60	25	X224467	X224468	
		10.1992	06.1994	GIRL-TRW	2	43	30	X374385	X374386	
		10.1992	06.1994	GIRL-TRW	1	36	10		X375021	X375022
		10.1992	06.1994	GIRL-TRW	1	43	20		X375023	X375024
		10.1992	06.1994	GIRL-TRW	1	43	20		X375131	X375132
S4 (8D5, B5)										
S4 quattro		09.1997	12.1998	GIRL-TRW	2	43	30	X374757	X374758	
		01.1999	09.2001	GIRL-TRW	2	43	30	X374609	X374610	
		09.1997	09.2001	GIRL-TRW	1	38	10		X375087	X375088
		09.1997	09.2001	GIRL-TRW	1	43	10		X375415	X375416
S4 (8E2, B6)										
S4 quattro		03.2003	12.2004	ATE	1	60	30	X224651	X224652	
		03.2003	12.2004	GIRL-TRW	1	43	22	X375391	X375392	
S4 (8E5, B6)										
S4 quattro		03.2003	12.2004	ATE	1	60	30	X224651	X224652	
		03.2003	12.2004	GIRL-TRW	1	43	22	X375391	X375392	
S4 (8EC, B7)										
S4 quattro		11.2004	05.2006	ATE	1	60	30	X224651	X224652	
		11.2004	05.2006	GIRL-TRW	1	43	22	X375391	X375392	

Affectations par Marques

Vehicule application - Zuordnung nach Marke und Fahrzeuge - Applicazione per marca e veicolo - Aplicacion por marca y vehiculo



AUDI



S4 (8ED, B7)

S4 quattro		11.2004	06.2008	ATE	1	60	30		X224651	X224652
		11.2004	06.2008	GIRL-TRW	1	43	22		X375391	X375392

S4 (8H7, B6, 8HE, B7)

S4 quattro		03.2004	03.2009	ATE	1	57	25/Ø288-312		X224433	X224434
		03.2004	03.2009	ATE	1	57	25/Ø288-312		X224833	X224834
		03.2004	03.2009	ATE	1	60	30/Ø321		X224749	X224750
		03.2004	05.2006	ATE	1	60	30/Ø345		X224651	X224652
		03.2004	05.2006	GIRL-TRW	1	43	22		X375391	X375392

S4 (8K2, B8)

S4 quattro		11.2008		GIRL-TRW	1	43	22/Ø330		X377063	X377064
------------	--	---------	--	----------	---	----	---------	--	---------	---------

S4 (8K5, B8)

S4 quattro		11.2008		GIRL-TRW	1	43	22/Ø330		X377063	X377064
------------	--	---------	--	----------	---	----	---------	--	---------	---------

S4 quattro (8D2, B5)

S4 quattro		09.1997	12.1998	GIRL-TRW	2	43	30		X374757	X374758
		01.1999	09.2001	GIRL-TRW	2	43	30		X374609	X374610
		09.1997	09.2001	GIRL-TRW	1	38	10	Fe	X375087	X375088
		09.1997	09.2001	GIRL-TRW	1	43	10	Al	X375415	X375416

S5 (8F7/8T3/8TA)

S5 quattro		06.2007		ATE	1	57	25		X224785	X224786
		06.2007		GIRL-TRW	1	57	30/Ø320		X374675	X374676
		06.2007		GIRL-TRW	1	57	30/Ø345		X374717	X374718
		06.2007		GIRL-TRW	1	43	22/Ø330		X377063	X377064

S6 (4A, C4)

S6 4.2 quattro		06.1994	10.1997	ATE	1	57	25		X224241	X224242
		06.1994	10.1997	GIRL-TRW	2	43	30		X374385	X374386
		06.1994	12.1997	GIRL-TRW	1	38	10/Ø245	#ID: 4060 4061	X375063	X375064
		06.1994	10.1997	GIRL-TRW	1	43	20		X375023	X375024
		06.1994	10.1997	GIRL-TRW	1	43	20		X375131	X375132
S6 Plus quattro		04.1996	10.1997	GIRL-TRW	2	43	30		X374765	X374766
S6 Turbo quattro		06.1994	10.1997	ATE	1	57	25		X224241	X224242
		06.1994	10.1997	GIRL-TRW	2	43	30		X374385	X374386
		06.1994	10.1997	GIRL-TRW	1	43	20		X375023	X375024
		06.1994	10.1997	GIRL-TRW	1	43	20		X375131	X375132

S6 (4B2, 4B5, C5)

S6 quattro		09.1999	01.2005	ATE	1	57	25/Ø288-312		X224433	X224434
		09.1999	01.2005	ATE	1	57	25/Ø288-312		X224833	X224834
		09.1999	01.2005	ATE	1	60	30		X224887	X224888
		09.1999	01.2005	GIRL-TRW	2	43	30/Ø321		X374609	X374610
		09.1999	01.2005	GIRL-TRW	1	43	22		X375309	X375310

S6 (4F2,4F5, C6)

S6 quattro		03.2006	03.2011	GIRL-TRW	1	43	22		X377025	X377026
------------	--	---------	---------	----------	---	----	----	--	---------	---------

X=1 : SNRA - X=2 : EAI - X=3 : SERA - X=4 : SEEC - X=5 : NEOTO - X=6 : STARTCAR

Affectations par Marques

Vehicule application - Zuordnung nach Marke und Fahrzeuge - Applicazione per marca e veicolo - Aplicacion por marca y vehiculo



AUDI



S6 (4G2, 4G5, C7)

S6 quattro		02.2012	04.2015	ATE	2	42	34/Ø356		X224857	X224858
		02.2012	04.2015	GIRL-TRW	1	60	30/Ø320		X374733	X374734
		02.2012	04.2015	GIRL-TRW	1	60	30/Ø345		X374735	X374736
		02.2012	04.2015	GIRL-TRW	1	43	12/Ø300		X377043	X377044
		02.2012	04.2015	GIRL-TRW	1	43	22/Ø330		X377045	X377046
		02.2012	04.2015	GIRL-TRW	1	43	30/Ø370		X377049	X377050

S7 (4GA)

S7 quattro		02.2012	03.2015	ATE	2	42	34/Ø356		X224857	X224858
		02.2012	03.2015	GIRL-TRW	1	60	30/Ø320		X374733	X374734
		02.2012	03.2015	GIRL-TRW	1	60	30/Ø345		X374735	X374736
		02.2012	03.2015	GIRL-TRW	1	43	12/Ø300		X377043	X377044
		02.2012	03.2015	GIRL-TRW	1	43	22/Ø330		X377045	X377046
		02.2012	03.2015	GIRL-TRW	1	43	30/Ø370		X377049	X377050

S8 (4D2, 4D8)

S 8 quattro		07.1996	12.1998	GIRL-TRW	2	43	30		X374651	X374652
		06.1999	09.2002	GIRL-TRW	2	43	30		X374407	X374408
		07.1996	12.1998	GIRL-TRW	1	43	20		X375139	X375140
		01.1999	09.2002	GIRL-TRW	1	43	22		X375189	X375190

TT (8J3, 8J9)

1.8 TFSI		06.2008	06.2014	GIRL-TRW	1	38	12		X375377	X375378
2.0 quattro		05.2008	06.2014	GIRL-TRW	1	41	22		X375379	X375380
2.0 TDI quattro		06.2008	06.2014	GIRL-TRW	1	41	12		X375313	X375314
		06.2008	06.2014	GIRL-TRW	1	41	22		X375379	X375380
2.0 TFSI		08.2006	06.2010	GIRL-TRW	1	38	12		X375377	X375378
2.0 TFSI quattro		05.2008	06.2010	GIRL-TRW	1	41	22		X375379	X375380
		06.2008	06.2010	GIRL-TRW	1	41	12		X375313	X375314
2.5 TFSI RS quattro		07.2009	06.2014	GIRL-TRW	1	41	22		X375379	X375380
3.2 V6 quattro		08.2006	06.2010	GIRL-TRW	1	41	12		X375313	X375314
		08.2006	06.2010	GIRL-TRW	1	41	22		X375379	X375380
Tout / All / Alle / Tutti / Todos		08.2006	06.2014	ATE	1	54	25/Ø288 -312		X224619	X224620
		08.2006	06.2014	ATE	1	57	30/Ø340		X224741	X224742

TT (8N3, 8N9)

1.8 T		10.1998	06.2006	GIRL-TRW	1	38	9		X375143	X375144
		10.1998	06.2006	GIRL-TRW	1	38	9		X375275	X375276
1.8 T quattro		10.1998	06.2006	GIRL-TRW	1	38	22		X375255	X375256
		10.1998	06.2006	GIRL-TRW	1	41	9		X375193	X375194
3.2 VR6 quattro		07.2003	06.2006	GIRL-TRW	1	38	22		X375255	X375256
Tout / All / Alle / Tutti / Todos		10.1998		ATE	1	54	25		X224249	X224250

TT (FV3)

1.8 TFSI		09.2014		GIRL-TRW	1	57	25		X374759	X374760
2.0 TDI		09.2014		GIRL-TRW	1	57	25		X374759	X374760
2.0 TFSI		09.2014		GIRL-TRW	1	57	25		X374759	X374760

X=1 : SNRA - X=2 : EAI - X=3 : SERA - X=4 : SEEC - X=5 : NEOTO - X=6 : STARTCAR

Affectations par Marques

Vehicule application - Zuordnung nach Marke und Fahrzeuge - Applicazione per marca e veicolo - Aplicacion por marca y vehiculo



AUDI



TT (FV3)

2.0 TFSI quattro		09.2014		GIRL-TRW	1	57	25		X374759	X374760
2.0 TTS		09.2014		GIRL-TRW	1	57	25		X374759	X374760
2.0 TTS quattro		09.2014		GIRL-TRW	1	57	25		X374759	X374760
Tout / All / Alle / Tutti / Todos		09.2014		ATE	1	38	10		X227001	X227002

V8 (44_, 4C_)

3.6 quattro		10.1988	11.1993	GIRL-TRW	1	43	20		X375023	X375024
		10.1988	11.1993	GIRL-TRW	1	43	20		X375131	X375132
4.2 quattro		10.1991	02.1994	GIRL-TRW	1	43	20		X375023	X375024
		10.1991	02.1994	GIRL-TRW	1	43	20		X375131	X375132
Tout / All / Alle / Tutti / Todos		10.1988	02.1994	ATE	1	60	25		X224467	X224468



AUSTIN



ALLEGRO

Tout / All / Alle / Tutti / Todos		12.1979	12.1984	GIRL-TRW	2	51	9,5		X374071	X374072
-----------------------------------	--	---------	---------	----------	---	----	-----	--	---------	---------

ALLEGRO (ADO 67)

Tout / All / Alle / Tutti / Todos		05.1973	12.1983	GIRL-TRW	2	51	9,5		X374071	X374072
-----------------------------------	--	---------	---------	----------	---	----	-----	--	---------	---------

METRO

Tout / All / Alle / Tutti / Todos		10.1980	08.1990	LOCK	4	36	20,7		X464001	X464002
-----------------------------------	--	---------	---------	------	---	----	------	--	---------	---------

MINI

Tout / All / Alle / Tutti / Todos		10.1967	06.1993	LOCK	2	51	9,5		X464025	X464026
-----------------------------------	--	---------	---------	------	---	----	-----	--	---------	---------



AUTO UNION



1000 SPORT

Tout / All / Alle / Tutti / Todos		01.1962	12.1964	ATE	2	48			X224537	X224538
-----------------------------------	--	---------	---------	-----	---	----	--	--	---------	---------

DKW F102

Tout / All / Alle / Tutti / Todos		03.1964	09.1967	ATE	2	48			X224525	X224526
-----------------------------------	--	---------	---------	-----	---	----	--	--	---------	---------

DKW F12

Tout / All / Alle / Tutti / Todos		10.1963	08.1966	ATE	2	42			X224649	X224650
-----------------------------------	--	---------	---------	-----	---	----	--	--	---------	---------



AUTOBIANCHI



A 112

Tout / All / Alle / Tutti / Todos		07.1971	12.1976	BENDIX	1	48	10		X254033	X254034
		07.1971	12.1985	BENDIX	1	48			X254247	X254248
		01.1974	12.1985	BENDIX	1	48	10,8		X254189	X254190
		01.1976	12.1985	BENDIX	1	48	10		X254023	X254024

PRIMULA

Tout / All / Alle / Tutti / Todos		01.1964	01.1966	BENDIX	1	48			X254247	X254248
		02.1966	12.1970	BENDIX	1	48			X254249	X254250
		01.1964	12.1970	BENDIX	1	32			X255081	X255082

X=1 : SNRA - X=2 : EAI - X=3 : SERA - X=4 : SEEAC - X=5 : NEOTO - X=6 : STARTCAR

Affectations par Marques

Vehicule application - Zuordnung nach Marke und Fahrzeuge - Applicazione per marca e veicolo - Aplicacion por marca y vehiculo



BEDFORD



CF2 VAN 220 - 250 - 280

Tout / All / Alle / Tutti / Todos		01.1984	12.1988	LOCK	2	57	14,5		X464087	X464088
-----------------------------------	--	---------	---------	------	---	----	------	--	---------	---------



BENTLEY



ARNAGE II

6.8 V8		02.1999	10.2009	ATE	2	44			X224747	X224748
--------	--	---------	---------	-----	---	----	--	--	---------	---------

CONTINENTAL

6.75 V8 S		05.1994	12.1995	ATE	2	60			X224657	X224658
-----------	--	---------	---------	-----	---	----	--	--	---------	---------



BMW



1 (E81)

116 d		11.2008	09.2012	GIRL-TRW	1	54	22/Ø284		X374619	X374620
		01.2011	12.2011	BREMBO	6	28/ 32/ 36	24		X284159	X284160
		11.2008	09.2012	GIRL-TRW	1	40	10		X375325	X375326
116 i		03.2007	09.2012	BREMBO	6	28/ 32/ 36	24		X284159	X284160
		03.2007	09.2012	GIRL-TRW	1	54	22/Ø284		X374619	X374620
		03.2007	09.2012	ATE	1	42	20	#ID: 911	X225367	X225368
		03.2007	09.2012	GIRL-TRW	1	40	10		X375325	X375326
118 d		09.2006	09.2012	BREMBO	6	28/ 32/ 36	24		X284159	X284160
		09.2006	09.2012	GIRL-TRW	1	54	22/Ø284		X374619	X374620
		09.2006	09.2012	ATE	1	40	20	#ID: 933	X225335	X225336
		09.2006	09.2012	ATE	1	42	20	#ID: 911	X225367	X225368
118 i		09.2006	09.2012	BREMBO	6	28/ 32/ 36	24		X284159	X284160
		09.2006	09.2012	GIRL-TRW	1	54	22/Ø284		X374619	X374620
		09.2006	09.2012	ATE	1	42	20	#ID: 911	X225367	X225368
		09.2006	09.2012	GIRL-TRW	1	40	10		X375325	X375326
120 d		09.2006	09.2012	ATE	1	54	24/Ø300		X224803	X224804
		09.2006	09.2012	BREMBO	6	28/ 32/ 36	24		X284159	X284160
		09.2006	09.2012	ATE	1	40	20	#ID: 933	X225335	X225336
		09.2006	09.2012	ATE	1	42	20	#ID: 911	X225367	X225368
120 i		09.2006	09.2012	ATE	1	54	24/Ø300		X224803	X224804
		09.2006	09.2012	BREMBO	6	28/ 32/ 36	24		X284159	X284160
		09.2006	09.2012	ATE	1	42	20	#ID: 911	X225367	X225368
		09.2006	09.2012	GIRL-TRW	1	40	10		X375325	X375326
123 d		03.2007	09.2012	ATE	1	54	24/Ø300		X224803	X224804
		03.2007	09.2012	BREMBO	6	28/ 32/ 36	24		X284159	X284160
		03.2007	09.2012	ATE	1	42	20	#ID: 911	X225367	X225368
130 i		09.2006	09.2012	ATE	1	54	24/Ø300		X224803	X224804
		09.2006	09.2012	BREMBO	6	28/ 32/ 36	24		X284159	X284160
		09.2006	09.2012	ATE	1	42	20	#ID: 911	X225367	X225368

Affectations par Marques

Vehicule application - Zuordnung nach Marke und Fahrzeuge - Applicazione per marca e veicolo - Aplicacion por marca y vehiculo



BMW



1 (E82)

118 d		09.2009	10.2013	BREMBO	6	28/ 32/ 36	24			X284159	X284160
		09.2009	10.2013	GIRL-TRW	1	54	22/Ø284			X374619	X374620
		09.2009	10.2013	ATE	1	40	20		#ID: 933	X225335	X225336
		09.2009	10.2013	ATE	1	42	20		#ID: 911	X225367	X225368
120 d		10.2007	10.2013	ATE	1	54	24/Ø300			X224803	X224804
		10.2007	10.2013	BREMBO	6	28/ 32/ 36	24			X284159	X284160
		10.2007	10.2013	ATE	1	40	20		#ID: 933	X225335	X225336
		10.2007	10.2013	ATE	1	42	20		#ID: 911	X225367	X225368
120 i		09.2009	10.2013	ATE	1	54	24/Ø300			X224803	X224804
		09.2009	10.2013	BREMBO	6	28/ 32/ 36	24			X284159	X284160
		09.2009	10.2013	ATE	1	40	20		#ID: 933	X225335	X225336
		09.2009	10.2013	ATE	1	42	20		#ID: 911	X225367	X225368
123 d		10.2007	10.2013	ATE	1	54	24/Ø300			X224803	X224804
		10.2007	10.2013	BREMBO	6	28/ 32/ 36	24			X284159	X284160
		10.2007	10.2013	ATE	1	42	20		#ID: 911	X225367	X225368
125 i		10.2007	10.2013	ATE	1	54	24/Ø300			X224803	X224804
		10.2007	10.2013	BREMBO	6	28/ 32/ 36	24			X284159	X284160
		10.2007	10.2013	ATE	1	40	20		#ID: 933	X225335	X225336
		10.2007	10.2013	ATE	1	42	20		#ID: 911	X225367	X225368
135 i		10.2007	10.2013	BREMBO	6	28/ 32/ 36	24			X284159	X284160
M		04.2011	06.2012	ATE	1	46	24			X225309	X225310
		04.2011	06.2012	ATE	1	46	24			X225435	X225436

1 (E87)

116 d		12.2008	09.2012	GIRL-TRW	1	54	22/Ø284			X374619	X374620
		01.2011	12.2011	BREMBO	6	28/ 32/ 36	24			X284159	X284160
		12.2008	09.2012	GIRL-TRW	1	40	10			X375325	X375326
116 i		11.2003	09.2012	BREMBO	6	28/ 32/ 36	24			X284159	X284160
		11.2003	09.2012	GIRL-TRW	1	54	22/Ø284			X374619	X374620
		11.2003	09.2012	ATE	1	42	20		#ID: 911	X225367	X225368
		11.2003	09.2012	GIRL-TRW	1	40	10			X375325	X375326
118 d		11.2003	09.2012	BREMBO	6	28/ 32/ 36	24			X284159	X284160
		11.2003	09.2012	GIRL-TRW	1	54	22/Ø284			X374619	X374620
		11.2003	09.2012	ATE	1	40	20		#ID: 933	X225335	X225336
		11.2003	09.2012	ATE	1	42	20		#ID: 911	X225367	X225368
		11.2003	09.2012	GIRL-TRW	1	40	10			X375325	X375326
118 i		07.2004	02.2008	BREMBO	6	28/ 32/ 36	24			X284159	X284160
		07.2004	02.2008	GIRL-TRW	1	54	22/Ø284			X374619	X374620
		07.2004	02.2008	ATE	1	42	20		#ID: 911	X225367	X225368
		07.2004	02.2008	GIRL-TRW	1	40	10			X375325	X375326

Affectations par Marques

Vehicule application - Zuordnung nach Marke und Fahrzeuge - Applicazione per marca e veicolo - Aplicacion por marca y vehiculo



BMW



1 (E87)

120 d		11.2003	09.2012	ATE	1	54	22/Ø292		X224659	X224660
		11.2003	09.2012	ATE	1	54	24/Ø300		X224803	X224804
		11.2003	09.2012	BREMBO	6	28/ 32/ 36	24		X284159	X284160
		11.2003	09.2012	ATE	1	40	20	#ID: 933	X225335	X225336
		11.2003	09.2012	ATE	1	42	20	#ID: 911	X225367	X225368
120 i		11.2003	09.2012	ATE	1	54	22/Ø292		X224659	X224660
		11.2003	09.2012	ATE	1	54	24/Ø300		X224803	X224804
		11.2003	09.2012	BREMBO	6	28/ 32/ 36	24		X284159	X284160
		11.2003	09.2012	GIRL-TRW	1	54	22/Ø284		X374619	X374620
		11.2003	09.2012	ATE	1	42	20	#ID: 911	X225367	X225368
		11.2003	09.2012	GIRL-TRW	1	40	10		X375325	X375326
123 d		03.2007	09.2012	ATE	1	54	24/Ø300		X224803	X224804
		03.2007	09.2012	BREMBO	6	28/ 32/ 36	24		X284159	X284160
		03.2007	09.2012	ATE	1	42	20	#ID: 911	X225367	X225368
130 i		03.2005	09.2012	ATE	1	54	24/Ø300		X224803	X224804
		03.2005	09.2012	BREMBO	6	28/ 32/ 36	24		X284159	X284160
		03.2005	09.2012	ATE	1	42	20	#ID: 911	X225367	X225368

1 (E88)

118 d		09.2008	12.2013	BREMBO	6	28/ 32/ 36	24		X284159	X284160
		09.2008	12.2013	GIRL-TRW	1	54	22/Ø284		X374619	X374620
118 i		03.2008	12.2013	BREMBO	6	28/ 32/ 36	24		X284159	X284160
		03.2008	12.2013	GIRL-TRW	1	54	22/Ø284		X374619	X374620
120 d		03.2008	12.2012	ATE	1	54	24/Ø300		X224803	X224804
		03.2008	12.2012	BREMBO	6	28/ 32/ 36	24		X284159	X284160
120 i		03.2008	12.2013	ATE	1	54	24/Ø300		X224803	X224804
		03.2008	12.2013	BREMBO	6	28/ 32/ 36	24		X284159	X284160
123 d		09.2008	12.2013	ATE	1	54	24/Ø300		X224803	X224804
		09.2008	12.2013	BREMBO	6	28/ 32/ 36	24		X284159	X284160
125 i		03.2008	12.2013	ATE	1	54	24/Ø300		X224803	X224804
		03.2008	12.2013	BREMBO	6	28/ 32/ 36	24		X284159	X284160
135 i		03.2008	08.2013	BREMBO	6	28/ 32/ 36	24		X284159	X284160
Tout / All / Alle / Tutti / Todos		09.2008	12.2013	ATE	1	40	20	#ID: 933	X225335	X225336
		09.2008	12.2013	ATE	1	42	20	#ID: 911	X225367	X225368

1 (F20, F21)

114 d		07.2012		BOSCH	1	54	22/Ø284		X274133	X274134
114 i		11.2011		BOSCH	1	54	22/Ø284		X274133	X274134
116 d		12.2010	02.2015	BOSCH	1	54	22/Ø284		X274133	X274134
116 i		12.2010		BOSCH	1	54	22/Ø284		X274133	X274134
118 d		12.2010		BOSCH	1	54	22/Ø284		X274133	X274134
118 d xDrive		07.2013		BOSCH	1	54	22/Ø300		X274129	X274130
118 i		11.2010		BOSCH	1	54	22/Ø300		X274129	X274130
120 d		12.2010		BOSCH	1	54	22/Ø300		X274129	X274130

X=1 : SNRA - X=2 : EAI - X=3 : SERA - X=4 : SEEAC - X=5 : NEOTO - X=6 : STARTCAR

Affectations par Marques

Vehicule application - Zuordnung nach Marke und Fahrzeuge - Applicazione per marca e veicolo - Aplicacion por marca y vehiculo



BMW



1 (F20, F21)

120 d xDrive		02.2012		BOSCH	1	54	22/Ø300		X274129	X274130
120 i		03.2015		BOSCH	1	54	22/Ø300		X274129	X274130
125 d		08.2011		BOSCH	1	57	24/Ø312 -330		X274135	X274136
125 i		08.2011		BOSCH	1	57	24/Ø312 -330		X274135	X274136
Tout / All / Alle / Tutti / Todos		12.2010		BOSCH	1	42	20/Ø300		X275079	X275080

02 (E10)

1502		01.1975	12.1976	ATE	2	48	10		X224369	X224370
1600 Ti		09.1967	11.1969	ATE	2	48	10		X224323	X224324
		09.1967	11.1969	ATE	4	34	10		X224039	X224040
1600/2		12.1967	12.1971	ATE	2	48	10		X224323	X224324
		12.1967	12.1971	ATE	4	34	10		X224039	X224040
1600-2		12.1967	10.1971	ATE	2	48	10		X224323	X224324
		12.1967	10.1971	ATE	4	34	10		X224039	X224040
1602		04.1971	07.1975	ATE	2	48	10		X224323	X224324
		04.1971	07.1975	ATE	4	34	10		X224039	X224040
2002		02.1968	07.1975	ATE	2	48	10		X224323	X224324
		02.1968	07.1975	ATE	4	34	10		X224039	X224040
2002 Ti		06.1968	04.1972	ATE	4	40	12,7		X224023	X224024

2 (F22, F87)

Tout / All / Alle / Tutti / Todos		10.2012		BOSCH	1	54	22/Ø284		X274133	X274134
		10.2012		BOSCH	1	57	24/Ø312 -330		X274135	X274136
		10.2012		BOSCH	1	42	20/Ø300		X275079	X275080

2 (F23)

Tout / All / Alle / Tutti / Todos		11.2014		BOSCH	1	54	22/Ø284		X274133	X274134
		11.2014		BOSCH	1	57	24/Ø312 -330		X274135	X274136
		11.2014		BOSCH	1	42	20/Ø300		X275079	X275080

3 (E21)

Tout / All / Alle / Tutti / Todos		08.1975	08.1977	ATE	2	48	12,7		X224095	X224096
		08.1975	08.1977	GIRL-TRW	2	48	12,7		X374125	X374126
		01.1978	03.1984	ATE	1	33	10		X225041	X225042

3 (E30)

316		09.1982	12.1987	ATE	1	48	22		X224199	X224200
		09.1982	12.1987	ATE	2	48	12,7		X224095	X224096
		09.1982	12.1987	GIRL-TRW	1	48	12,7		X374015	X374016
		09.1982	12.1987	GIRL-TRW	1	48	22		X374017	X374018
		09.1982	12.1987	GIRL-TRW	2	48	12,7		X374125	X374126
		09.1982	12.1987	ATE	1	33	10		X225047	X225048

Affectations par Marques

Vehicule application - Zuordnung nach Marke und Fahrzeuge - Applicazione per marca e veicolo - Aplicacion por marca y vehiculo



BMW



3 (E30)

316 (Ecotronic)		09.1983	12.1990	ATE	1	48	22		X224199	X224200
		09.1983	12.1987	ATE	2	48	12,7		X224095	X224096
		09.1983	12.1990	GIRL-TRW	1	48	12,7		X374015	X374016
		09.1983	12.1990	GIRL-TRW	1	48	22		X374017	X374018
		09.1983	12.1987	GIRL-TRW	2	48	12,7		X374125	X374126
		09.1983	12.1990	ATE	1	33	10		X225047	X225048
316 i		08.1987	06.1991	ATE	1	48	22		X224199	X224200
		08.1987	06.1991	GIRL-TRW	1	48	12,7		X374015	X374016
		08.1987	06.1994	GIRL-TRW	1	48	22		X374017	X374018
		08.1987	06.1991	ATE	1	33	10		X225047	X225048
		06.1991	06.1994	ATE	1	35	10		X225097	X225098
318 i		09.1982	11.1990	ATE	1	48	22		X224199	X224200
		09.1982	11.1990	GIRL-TRW	1	48	12,7		X374015	X374016
		09.1982	11.1990	GIRL-TRW	1	48	22		X374017	X374018
		09.1982	11.1990	ATE	1	33	10		X225047	X225048
		09.1987	06.1994	ATE	1	35	10		X225097	X225098
318 is		09.1989	08.1991	ATE	1	48	22		X224199	X224200
		09.1989	08.1991	GIRL-TRW	1	48	12,7		X374015	X374016
		09.1989	08.1991	GIRL-TRW	1	48	22		X374017	X374018
		09.1989	08.1991	ATE	1	33	10		X225047	X225048
320 i		09.1982	10.1993	ATE	1	48	22		X224199	X224200
		09.1982	10.1993	GIRL-TRW	1	48	22		X374017	X374018
		09.1982	10.1993	ATE	1	33	10		X225047	X225048
		01.1988	12.1991	ATE	1	35	10		X225097	X225098
320 is		05.1988	12.1990	ATE	1	48	22		X224199	X224200
		05.1988	12.1990	GIRL-TRW	1	48	22		X374017	X374018
		05.1988	12.1990	ATE	1	33	10		X225047	X225048
323 i		09.1982	08.1986	GIRL-TRW	1	48	22		X374017	X374018
		09.1982	08.1986	ATE	1	33	10		X225047	X225048
324 d		09.1985	08.1990	ATE	1	48	22		X224199	X224200
		09.1985	08.1990	GIRL-TRW	1	48	22		X374017	X374018
		09.1985	08.1990	ATE	1	33	10		X225047	X225048
324 td		09.1987	08.1990	ATE	1	48	22		X224199	X224200
		09.1987	08.1990	GIRL-TRW	1	48	22		X374017	X374018
		09.1987	08.1990	ATE	1	33	10		X225047	X225048
		01.1988	06.1993	ATE	1	35	10		X225097	X225098
325 e 2.7		10.1983	10.1987	ATE	1	48	22		X224199	X224200
		10.1983	10.1987	GIRL-TRW	1	48	22		X374017	X374018
		10.1983	10.1987	ATE	1	33	10		X225047	X225048
325 i		09.1983	12.1990	ATE	1	48	22		X224199	X224200
		09.1983	12.1990	GIRL-TRW	1	48	22		X374017	X374018
		09.1983	12.1990	ATE	1	33	10		X225047	X225048
		07.1987	03.1993	ATE	1	35	10		X225097	X225098

Affectations par Marques

Vehicule application - Zuordnung nach Marke und Fahrzeuge - Applicazione per marca e veicolo - Aplicacion por marca y vehiculo



BMW



3 (E30)

325 i X		03.1986	08.1990	GIRL-TRW	1	48	22		X374017	X374018
		03.1986	08.1990	ATE	1	33	10		X225047	X225048
		06.1988	10.1993	ATE	1	35	19		X225103	X225104
M3 2.3		07.1986	02.1988	ATE	1	54	25		X224425	X224426
		07.1986	02.1988	ATE	1	38	12		X225077	X225078
M3 EVO I 2.3		10.1988	10.1990	ATE	1	54	25		X224425	X224426
		10.1988	10.1990	ATE	1	38	12		X225077	X225078
M3 EVO II 2.5		01.1990	01.1992	ATE	1	54	25		X224425	X224426
		01.1990	01.1992	ATE	1	38	12		X225077	X225078

3 (E36)

316 g		03.1994	08.2000	ATE	1	34	10		X225177	X225178
316 i		09.1990	04.1999	ATE	1	36	10		X225107	X225108
		03.1994	08.2000	ATE	1	34	10		X225177	X225178
		01.1996	10.1999	ATE	1	38	10		X225175	X225176
318 i		12.1990	02.1998	ATE	1	36	10		X225107	X225108
		01.1994	10.1999	ATE	1	38	10		X225175	X225176
318 is		03.1992	08.1996	ATE	1	36	10		X225107	X225108
318 tds		01.1995	08.2000	ATE	1	34	10		X225177	X225178
		01.1995	02.1998	ATE	1	36	10		X225107	X225108
		01.1995	10.1999	ATE	1	38	10		X225175	X225176
318 ti		11.1994	08.2000	ATE	1	34	10		X225177	X225178
320 i		09.1990	04.1999	ATE	1	34	10		X225105	X225106
		09.1990	09.1994	ATE	1	36	10		X225107	X225108
		12.1993	10.1999	ATE	1	38	10		X225175	X225176
323 i		03.1995	04.1999	ATE	1	36	10		X225107	X225108
		03.1995	10.1999	ATE	1	38	19		X225173	X225174
323 i 2.5		03.1995	02.1998	ATE	1	36	10		X225107	X225108
		03.1995	02.1998	ATE	1	38	19		X225173	X225174
323 ti		08.1997	08.2000	ATE	1	34	10		X225177	X225178
325 i		09.1990	03.1995	ATE	1	36	10		X225107	X225108
		03.1993	03.1995	ATE	1	38	19		X225173	X225174
325 td		09.1991	02.1998	ATE	1	34	10		X225105	X225106
		09.1991	02.1998	ATE	1	36	10		X225107	X225108
325 tds		05.1993	02.1998	ATE	1	36	10		X225107	X225108
		01.1995	10.1999	ATE	1	38	10		X225175	X225176
328 i		01.1995	04.1999	ATE	1	36	10		X225107	X225108
		01.1995	10.1999	ATE	1	38	19		X225173	X225174
M3		10.1992	03.1995	ATE	1	60	28/Ø302-315		X224291	X224292
		10.1992	04.1999	ATE	1	40	20		X225171	X225172
Tout / All / Alle / Tutti / Todos		09.1990	08.2000	ATE	1	54	12		X224261	X224262
		09.1990	08.2000	ATE	1	54	22		X224263	X224264

Affectations par Marques

Vehicule application - Zuordnung nach Marke und Fahrzeuge - Applicazione per marca e veicolo - Aplicacion por marca y vehiculo



BMW



3 (E46)											
316 Ci		04.2000	10.2003	ATE	1	54	22			X224263	X224264
		04.2000	10.2003	ATE	1	40	10			X225217	X225218
316 i		09.1998	02.2005	ATE	1	54	22			X224263	X224264
		09.1998	02.2005	ATE	1	40	10			X225217	X225218
		09.1998	02.2005	ATE	1	40	19			X225209	X225210
316 ti		06.2001	02.2005	ATE	1	54	22			X224263	X224264
		06.2001	02.2005	ATE	1	40	10			X225217	X225218
318 Ci		11.1999	09.2001	ATE	1	54	22			X224263	X224264
		11.1999	09.2001	ATE	1	40	10			X225217	X225218
		09.2001	07.2003	ATE	1	40	19			X225209	X225210
318 d		09.2001	02.2003	ATE	1	54	22			X224263	X224264
		09.2001	02.2003	ATE	1	40	19			X225209	X225210
318 i		02.1998	06.2001	ATE	1	54	22			X224263	X224264
		02.1998	09.2001	ATE	1	40	10			X225217	X225218
		02.1998	06.2001	ATE	1	40	19			X225209	X225210
318 td		03.2003	02.2005	ATE	1	54	22			X224263	X224264
		03.2003	02.2005	ATE	1	40	19			X225209	X225210
318 ti		09.2001	02.2005	ATE	1	54	22			X224263	X224264
		09.2001	02.2005	ATE	1	40	19			X225209	X225210
320 Cd		11.2003	02.2007	ATE	1	54	22			X224263	X224264
		11.2003	02.2007	ATE	1	40	19			X225209	X225210
320 Ci		08.1999	02.2007	ATE	1	54	22			X224263	X224264
		08.1999	02.2007	ATE	1	40	19			X225209	X225210
320 d		02.1998	06.2001	ATE	1	54	22			X224263	X224264
		02.1998	06.2001	ATE	1	40	19			X225209	X225210
320 i		03.1998	02.2005	ATE	1	54	22			X224263	X224264
		03.1998	02.2005	ATE	1	40	19			X225209	X225210
320 td		09.2001	02.2005	ATE	1	54	22			X224263	X224264
		09.2001	02.2005	ATE	1	40	19			X225209	X225210
323 Ci		04.1999	09.2000	ATE	1	54	22			X224263	X224264
		04.1999	09.2000	ATE	1	40	19			X225209	X225210
323 i		03.1998	09.2000	ATE	1	54	22			X224263	X224264
		03.1998	09.2000	ATE	1	40	19			X225209	X225210
325 Ci		09.2000	02.2007	ATE	1	54	22			X224263	X224264
		09.2000	02.2007	ATE	1	40	19			X225209	X225210
325 i		09.2000	02.2005	ATE	1	54	22			X224263	X224264
		09.2000	02.2005	ATE	1	57	25			X224555	X224556
		09.2000	02.2005	ATE	1	40	19			X225209	X225210
		09.2000	02.2005	ATE	1	40	22			X225361	X225362
		09.2000	02.2005	ATE	1	42	22			X225271	X225272
325 ti		06.2001	02.2005	ATE	1	54	22			X224263	X224264
		06.2001	02.2005	ATE	1	40	19			X225209	X225210

Affectations par Marques

Vehicule application - Zuordnung nach Marke und Fahrzeuge - Applicazione per marca e veicolo - Aplicacion por marca y vehiculo

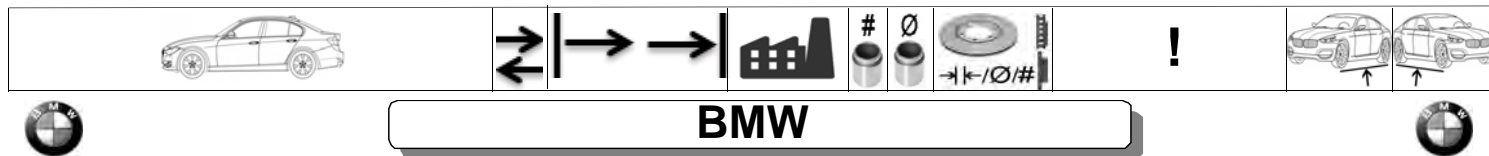

3 (E46)

325 xi		09.2000	02.2005	ATE	1	54	22		X224263	X224264
		09.2000	02.2005	ATE	1	57	25		X224555	X224556
		09.2000	02.2005	ATE	1	40	19		X225209	X225210
		09.2000	02.2005	ATE	1	40	22		X225361	X225362
328 Ci		04.1999	06.2000	ATE	1	54	22		X224263	X224264
		04.1999	06.2000	ATE	1	40	19		X225209	X225210
328 i		02.1998	06.2000	ATE	1	54	22		X224263	X224264
		02.1998	06.2000	ATE	1	40	19		X225209	X225210
330 Cd		03.2003	02.2007	ATE	1	57	25		X224555	X224556
		03.2003	02.2007	ATE	1	42	22		X225271	X225272
330 Ci		06.2000	02.2007	ATE	1	57	25		X224555	X224556
		06.2000	02.2007	ATE	1	42	22		X225271	X225272
330 d		10.1999	02.2003	ATE	1	57	25		X224555	X224556
		10.1999	02.2003	ATE	1	42	22		X225271	X225272
330 i		06.2000	02.2005	ATE	1	57	25		X224555	X224556
		06.2000	02.2005	ATE	1	42	22		X225271	X225272
330 xd		06.2000	02.2003	ATE	1	57	25		X224555	X224556
		06.2000	02.2003	ATE	1	40	22		X225361	X225362
330 xi		06.2000	02.2005	ATE	1	57	25		X224555	X224556
		06.2000	02.2005	ATE	1	40	22		X225361	X225362
M3		06.2000	02.2007	ATE	1	60	28		X224849	X224850
M3 3.2		06.2000	11.2004	ATE	1	42	20		X225419	X225420
		06.2000		ATE	1	46	20		X225421	X225422
M3 CSL		06.2003		ATE	1	46	20		X225421	X225422

3 (E90)

316 d		07.2009	12.2011	ATE	1	54	24/Ø300		X224803	X224804
		07.2009	12.2011	ATE	1	42	20/Ø300		X225367	X225368
		07.2009	12.2011	GIRL-TRW	1	40	10		X375325	X375326
316 i		02.2006	02.2007	ATE	1	54	22/Ø292		X224659	X224660
		02.2006	12.2011	ATE	1	54	24/Ø300		X224803	X224804
		02.2006	12.2011	BREMBO	6	28/ 32/ 36	24		X284159	X284160
		02.2006	12.2011	ATE	1	42	20/Ø300		X225367	X225368
		02.2006	12.2011	GIRL-TRW	1	40	10		X375325	X375326
318 d		09.2005	06.2007	ATE	1	54	22/Ø292		X224659	X224660
		09.2005	12.2011	ATE	1	54	24/Ø300		X224803	X224804
		09.2005	06.2007	ATE	1	57	24/Ø300		X224805	X224806
		09.2005	06.2007	ATE	1	57	24/Ø312		X224753	X224754
		09.2005	06.2007	BREMBO	6	28/ 32/ 36	24		X284159	X284160
		09.2005	06.2007	ATE	1	42	20/Ø300		X225367	X225368
		09.2005	06.2007	GIRL-TRW	1	40	10		X375325	X375326

Affectations par Marques

Vehicule application - Zuordnung nach Marke und Fahrzeuge - Applicazione per marca e veicolo - Aplicacion por marca y vehiculo



BMW



3 (E90)

318 i		09.2005	03.2007	ATE	1	54	22/Ø292		X224659	X224660
		09.2005	12.2011	ATE	1	54	24/Ø300	Fe	X224803	X224804
		09.2005	03.2007	ATE	1	57	24/Ø300	Al	X224805	X224806
		09.2005	03.2007	ATE	1	57	24/Ø312		X224753	X224754
		09.2005	12.2011	BREMBO	6	28/ 32/ 36	24		X284159	X284160
		09.2005	12.2011	ATE	1	42	20/Ø300		X225367	X225368
		09.2005	03.2007	GIRL-TRW	1	40	10		X375325	X375326
320 d		01.2005	06.2007	ATE	1	57	24/Ø300	Al	X224805	X224806
		01.2005	06.2007	ATE	1	57	24/Ø312		X224753	X224754
		01.2005	06.2007	ATE	1	57	24/Ø330	Al	X224699	X224700
		01.2005	06.2007	BREMBO	6	28/ 32/ 36	24		X284159	X284160
		01.2005	06.2007	ATE	1	42	20/Ø300		X225367	X225368
		01.2005	06.2007	ATE	1	44	22/Ø336		X225353	X225354
320 d xDrive		07.2008	12.2011	ATE	1	57	24/Ø300	Al	X224805	X224806
		07.2008	12.2011	ATE	1	57	24/Ø312		X224753	X224754
		07.2008	12.2011	ATE	1	57	24/Ø330	Al	X224699	X224700
		07.2008	12.2011	ATE	1	42	20/Ø300		X225367	X225368
		07.2008	12.2011	ATE	1	44	22/Ø336		X225353	X225354
320 i		01.2005	03.2007	ATE	1	54	22/Ø292		X224659	X224660
		01.2005	12.2011	ATE	1	57	24/Ø300	Al	X224805	X224806
		01.2005	12.2011	ATE	1	57	24/Ø312		X224753	X224754
		03.2007	12.2011	ATE	1	54	24/Ø300	Fe	X224803	X224804
		01.2005	12.2011	ATE	1	42	20/Ø300		X225367	X225368
		01.2005	03.2007	GIRL-TRW	1	40	10		X375325	X375326
320 si		05.2006	06.2007	ATE	1	57	24/Ø300	Al	X224805	X224806
		05.2006	06.2007	ATE	1	57	24/Ø312		X224753	X224754
		05.2006	06.2007	ATE	1	42	20/Ø300		X225367	X225368
320 xd		09.2007	12.2011	ATE	1	57	24/Ø300	Al	X224805	X224806
		09.2007	12.2011	ATE	1	57	24/Ø312		X224753	X224754
		09.2007	12.2011	ATE	1	57	24/Ø330	Al	X224699	X224700
		09.2007	12.2011	ATE	1	42	20/Ø300		X225367	X225368
		09.2007	12.2011	ATE	1	44	22/Ø336		X225353	X225354
323 i		04.2006	06.2007	ATE	1	57	24/Ø300	Al	X224805	X224806
		04.2006	06.2007	ATE	1	57	24/Ø312		X224753	X224754
		04.2006	06.2007	BREMBO	6	28/ 32/ 36	24		X284159	X284160
		04.2006	06.2007	ATE	1	42	20/Ø300		X225367	X225368
325 d		09.2006	12.2011	ATE	1	57	24/Ø330	Al	X224699	X224700
		09.2006	12.2011	ATE	1	57	30/Ø348		X224739	X224740
		09.2006	12.2011	BREMBO	6	28/ 32/ 36	24		X284159	X284160
		09.2006	12.2011	ATE	1	44	22/Ø336		X225353	X225354

Affectations par Marques

Vehicule application - Zuordnung nach Marke und Fahrzeuge - Applicazione per marca e veicolo - Aplicacion por marca y vehiculo



BMW



3 (E90)

325 i		01.2005	12.2011	ATE	1	57	24/Ø300	[A]	X224805	X224806
		01.2005	12.2011	ATE	1	57	24/Ø312		X224753	X224754
		01.2005	12.2011	ATE	1	57	24/Ø330	[A]	X224699	X224700
		01.2005	12.2011	BREMBO	6	28/ 32/ 36	24		X284159	X284160
		01.2005	12.2011	ATE	1	42	20/Ø300		X225367	X225368
		01.2005	12.2011	ATE	1	44	22/Ø336		X225353	X225354
325 i xDrive		09.2008	12.2011	ATE	1	57	24/Ø300	[A]	X224805	X224806
		09.2008	12.2011	ATE	1	57	24/Ø312		X224753	X224754
		09.2008	12.2011	ATE	1	57	24/Ø330	[A]	X224699	X224700
		09.2008	12.2011	ATE	1	42	20/Ø300		X225367	X225368
		09.2008	12.2011	ATE	1	44	22/Ø336		X225353	X225354
325 xi		01.2005	12.2011	ATE	1	57	24/Ø300	[A]	X224805	X224806
		01.2005	12.2011	ATE	1	57	24/Ø312		X224753	X224754
		01.2005	12.2011	ATE	1	57	24/Ø330	[A]	X224699	X224700
		01.2005	12.2011	ATE	1	42	20/Ø300		X225367	X225368
		01.2005	12.2011	ATE	1	44	22/Ø336		X225353	X225354
330 d		09.2005	09.2007	ATE	1	57	24/Ø330	[A]	X224699	X224700
		09.2005	12.2011	ATE	1	57	30/Ø348		X224739	X224740
		01.2009	12.2011	BREMBO	6	28/ 32/ 36	24		X284159	X284160
		09.2005	08.2008	ATE	1	44	22/Ø336		X225353	X225354
330 d xDrive		01.2009	12.2011	ATE	1	57	24/Ø330	[A]	X224699	X224700
		01.2009	08.2009	ATE	1	57	30/Ø348		X224739	X224740
		01.2009	12.2011	ATE	1	44	22/Ø336		X225353	X225354
330 i		01.2005	12.2011	ATE	1	57	24/Ø330	[A]	X224699	X224700
		01.2005	12.2011	ATE	1	57	30/Ø348		X224739	X224740
		01.2005	12.2011	BREMBO	6	28/ 32/ 36	24		X284159	X284160
		01.2005	12.2011	ATE	1	44	22/Ø336		X225353	X225354
330 i xDrive		09.2008	12.2011	ATE	1	57	24/Ø330	[A]	X224699	X224700
		09.2008	12.2011	ATE	1	57	30/Ø348		X224739	X224740
		09.2008	12.2011	ATE	1	44	22/Ø336		X225353	X225354
330 xd		09.2005	09.2007	ATE	1	57	24/Ø330	[A]	X224699	X224700
		09.2005	12.2011	ATE	1	57	30/Ø348		X224739	X224740
		09.2005	08.2008	ATE	1	44	22/Ø336		X225353	X225354
330 xi		01.2005	12.2011	ATE	1	57	24/Ø330	[A]	X224699	X224700
		01.2005	12.2011	ATE	1	57	30/Ø348		X224739	X224740
		01.2005	12.2011	ATE	1	44	22/Ø336		X225353	X225354
335 d		09.2006	12.2011	ATE	1	57	30/Ø348		X224739	X224740
		09.2006	12.2011	ATE	1	44	22/Ø336		X225353	X225354
335 i		09.2006	12.2011	ATE	1	57	30/Ø348		X224739	X224740
		09.2006	12.2011	ATE	1	44	22/Ø336		X225353	X225354
335 i xDrive		09.2008	12.2011	ATE	1	57	30/Ø348		X224739	X224740
		09.2008	12.2011	ATE	1	44	22/Ø336		X225353	X225354

Affectations par Marques

Vehicule application - Zuordnung nach Marke und Fahrzeuge - Applicazione per marca e veicolo - Aplicacion por marca y vehiculo



BMW



3 (E90)











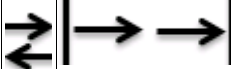



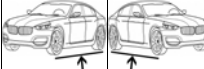

































335 xi		09.2007	12.2011	ATE	1	57	30/Ø348		X224739	X224740
		09.2007	12.2011	ATE	1	44	22/Ø336		X225353	X225354
M3 4.0		03.2007	12.2011	ATE	1	46	24		X225309	X225310
		03.2007	12.2011	ATE	1	46	24		X225435	X225436

3 (E91)

316 d		09.2009	06.2012	ATE	1	54	24/Ø300	Fe	X224803	X224804
		09.2009	06.2012	ATE	1	42	20/Ø300		X225367	X225368
316 i		05.2008	05.2012	ATE	1	54	24/Ø300	Fe	X224803	X224804
		05.2008	05.2012	BREMBO	6	28/ 32/ 36	24		X284159	X284160
		05.2008	05.2012	ATE	1	42	20/Ø300		X225367	X225368
318 d		09.2005	06.2012	ATE	1	57	24/Ø300	Al	X224805	X224806
		09.2005	06.2012	ATE	1	57	24/Ø312		X224753	X224754
		07.2007	06.2012	BREMBO	6	28/ 32/ 36	24		X284159	X284160
		09.2005	06.2012	ATE	1	42	20/Ø300		X225367	X225368
318 i		01.2006	12.2011	ATE	1	54	24/Ø300	Fe	X224803	X224804
		01.2006	12.2011	ATE	1	57	24/Ø300	Al	X224805	X224806
		01.2006	12.2011	ATE	1	57	24/Ø312		X224753	X224754
		01.2006	12.2011	ATE	1	42	20/Ø300		X225367	X225368
320 d		09.2005	06.2007	ATE	1	57	24/Ø300	Al	X224805	X224806
		09.2005	06.2007	ATE	1	57	24/Ø312		X224753	X224754
		09.2005	06.2007	ATE	1	57	24/Ø330	Al	X224699	X224700
		09.2005	06.2007	BREMBO	6	28/ 32/ 36	24		X284159	X284160
		09.2005	06.2007	ATE	1	42	20/Ø300		X225367	X225368
		09.2005	06.2007	ATE	1	44	22/Ø336		X225353	X225354
320 d xDrive		09.2008	06.2012	ATE	1	57	24/Ø300	Al	X224805	X224806
		09.2008	06.2012	ATE	1	57	24/Ø312		X224753	X224754
		09.2008	06.2012	ATE	1	57	24/Ø330	Al	X224699	X224700
		09.2008	06.2012	ATE	1	42	20/Ø300		X225367	X225368
		09.2008	06.2012	ATE	1	44	22/Ø336		X225353	X225354
320 i		09.2005	06.2012	ATE	1	57	24/Ø300	Al	X224805	X224806
		09.2005	06.2012	ATE	1	57	24/Ø312		X224753	X224754
		09.2005	06.2012	BREMBO	6	28/ 32/ 36	24		X284159	X284160
		09.2005	06.2012	ATE	1	42	20/Ø300		X225367	X225368
320 xd		09.2007	08.2008	ATE	1	57	24/Ø300	Al	X224805	X224806
		09.2007	08.2008	ATE	1	57	24/Ø312		X224753	X224754
		09.2007	08.2008	ATE	1	57	24/Ø330	Al	X224699	X224700
		09.2007	08.2008	ATE	1	42	20/Ø300		X225367	X225368
		09.2007	08.2008	ATE	1	44	22/Ø336		X225353	X225354
323 i		04.2006	06.2007	ATE	1	57	24/Ø300	Al	X224805	X224806
		04.2006	06.2007	ATE	1	57	24/Ø312		X224753	X224754
		04.2006	06.2007	BREMBO	6	28/ 32/ 36	24		X284159	X284160
		04.2006	06.2007	ATE	1	42	20/Ø300		X225367	X225368

Affectations par Marques

Vehicule application - Zuordnung nach Marke und Fahrzeuge - Applicazione per marca e veicolo - Aplicacion por marca y vehiculo

      	
 <div style="border: 1px solid black; padding: 5px; text-align: center; font-weight: bold; font-size: 1.2em;">BMW</div> 	
3 (E91)	
325 d	 09.2006 06.2012 ATE 1 57 24/Ø330 A X224699 X224700
	 09.2006 06.2012 ATE 1 57 30/Ø348 X224739 X224740
	 04.2010 06.2012 BREMBO 6 ^{28/ 32/} ₃₆ 24 X284159 X284160
	 09.2006 06.2012 ATE 1 44 22/Ø336 X225353 X225354
325 i	 09.2005 06.2007 ATE 1 57 24/Ø300 A X224805 X224806
	 09.2005 06.2007 ATE 1 57 24/Ø312 X224753 X224754
	 09.2005 06.2007 ATE 1 57 24/Ø330 A X224699 X224700
	 09.2005 06.2007 BREMBO 6 ^{28/ 32/} ₃₆ 24 X284159 X284160
	 09.2005 06.2007 ATE 1 42 20/Ø300 X225367 X225368
	 09.2005 06.2007 ATE 1 44 22/Ø336 X225353 X225354
325 i xDrive	 09.2008 06.2012 ATE 1 57 24/Ø330 A X224699 X224700
	 09.2008 06.2012 ATE 1 44 22/Ø336 X225353 X225354
325 xi	 09.2005 06.2007 ATE 1 57 24/Ø300 A X224805 X224806
	 09.2005 06.2007 ATE 1 57 24/Ø312 X224753 X224754
	 09.2005 06.2007 ATE 1 57 24/Ø330 A X224699 X224700
	 09.2005 06.2007 ATE 1 42 20/Ø300 X225367 X225368
	 09.2005 06.2007 ATE 1 44 22/Ø336 X225353 X225354
330 d	 09.2005 08.2008 ATE 1 57 30/Ø348 X224739 X224740
	 01.2009 06.2012 ATE 1 57 24/Ø330 A X224699 X224700
	 09.2005 08.2008 ATE 1 44 22/Ø336 X225353 X225354
330 d xDrive	 01.2009 06.2012 ATE 1 57 24/Ø330 A X224699 X224700
	 01.2009 06.2012 ATE 1 57 30/Ø348 X224739 X224740
	 01.2009 06.2012 ATE 1 44 22/Ø336 X225353 X225354
330 i	 09.2005 06.2012 ATE 1 57 24/Ø330 A X224699 X224700
	 09.2005 08.2009 ATE 1 57 30/Ø348 X224739 X224740
	 09.2007 06.2012 BREMBO 6 ^{28/ 32/} ₃₆ 24 X284159 X284160
	 09.2005 06.2012 ATE 1 44 22/Ø336 X225353 X225354
330 i xDrive	 09.2008 06.2012 ATE 1 57 24/Ø330 A X224699 X224700
	 09.2008 06.2012 ATE 1 57 30/Ø348 X224739 X224740
	 09.2008 06.2012 ATE 1 44 22/Ø336 X225353 X225354
330 xd	 09.2005 09.2007 ATE 1 57 24/Ø330 A X224699 X224700
	 09.2005 06.2012 ATE 1 57 30/Ø348 X224739 X224740
	 09.2005 08.2008 ATE 1 44 22/Ø336 X225353 X225354
330 xi	 09.2005 06.2012 ATE 1 57 24/Ø330 A X224699 X224700
	 09.2005 08.2009 ATE 1 57 30/Ø348 X224739 X224740
	 09.2005 06.2012 ATE 1 44 22/Ø336 X225353 X225354
335 d	 09.2006 06.2012 ATE 1 57 30/Ø348 X224739 X224740
	 09.2006 06.2012 ATE 1 44 22/Ø336 X225353 X225354
335 i	 09.2006 06.2012 ATE 1 57 30/Ø348 X224739 X224740
	 09.2006 06.2012 ATE 1 44 22/Ø336 X225353 X225354
335 i xDrive	 09.2008 06.2012 ATE 1 57 30/Ø348 X224739 X224740
	 09.2008 06.2012 ATE 1 44 22/Ø336 X225353 X225354

Affectations par Marques

Vehicule application - Zuordnung nach Marke und Fahrzeuge - Applicazione per marca e veicolo - Aplicacion por marca y vehiculo



BMW



3 (E91)

335 xi		09.2007	06.2012	ATE	1	57	30/Ø348		X224739	X224740
		09.2007	06.2012	ATE	1	44	22/Ø336		X225353	X225354

3 (E92)

316 i		09.2007	12.2013	ATE	1	54	24/Ø300	Fe	X224803	X224804
		09.2007	12.2013	BREMBO	6	28/ 32/ 36	24		X284159	X284160
		09.2007	12.2013	ATE	1	42	20/Ø300		X225367	X225368
		09.2007	12.2013	GIRL-TRW	1	40	10		X375325	X375326
318 i		03.2010	12.2013	ATE	1	54	24/Ø300	Fe	X224803	X224804
		03.2010	12.2013	BREMBO	6	28/ 32/ 36	24		X284159	X284160
		03.2010	12.2013	ATE	1	42	20/Ø300		X225367	X225368
320 d		01.2007	08.2009	ATE	1	57	24/Ø300	Al	X224805	X224806
		01.2007	08.2009	ATE	1	57	24/Ø312		X224753	X224754
		03.2007	08.2009	BREMBO	6	28/ 32/ 36	24		X284159	X284160
		01.2007	08.2009	ATE	1	42	20/Ø300		X225367	X225368
320 d xDrive		09.2008	07.2011	ATE	1	57	24/Ø300	Al	X224805	X224806
		09.2008	07.2011	ATE	1	57	24/Ø312		X224753	X224754
		09.2008	07.2011	ATE	1	42	20/Ø300		X225367	X225368
320 i		11.2006	06.2007	ATE	1	54	24/Ø300	Fe	X224803	X224804
		11.2006	06.2007	BREMBO	6	28/ 32/ 36	24		X284159	X284160
		11.2006	06.2007	ATE	1	42	20/Ø300		X225367	X225368
320 xd		03.2007	08.2008	ATE	1	57	24/Ø300	Al	X224805	X224806
		03.2007	08.2008	ATE	1	57	24/Ø312		X224753	X224754
		03.2007	08.2008	ATE	1	42	20/Ø300		X225367	X225368
323 i		06.2006	08.2008	ATE	1	57	24/Ø300	Al	X224805	X224806
		06.2006	08.2008	ATE	1	57	24/Ø312		X224753	X224754
		06.2006	08.2008	BREMBO	6	28/ 32/ 36	24		X284159	X284160
		06.2006	08.2008	ATE	1	42	20/Ø300		X225367	X225368
325 d		03.2007	03.2010	ATE	1	57	24/Ø330	Al	X224699	X224700
		03.2007	03.2010	BREMBO	6	28/ 32/ 36	24		X284159	X284160
		03.2007	03.2010	ATE	1	44	22/Ø336		X225353	X225354
325 i		09.2006	12.2013	ATE	1	57	24/Ø300	Al	X224805	X224806
		09.2006	12.2013	ATE	1	57	24/Ø312		X224753	X224754
		09.2006	12.2013	ATE	1	57	24/Ø330	Al	X224699	X224700
		09.2006	12.2013	BREMBO	6	28/ 32/ 36	24		X284159	X284160
		09.2006	12.2013	ATE	1	42	20/Ø300		X225367	X225368
325 i xDrive		09.2008	12.2013	ATE	1	57	24/Ø330	Al	X224699	X224700
		09.2008	12.2013	ATE	1	42	20/Ø300		X225367	X225368
325 xi		09.2006	12.2013	ATE	1	57	24/Ø300	Al	X224805	X224806
		09.2006	12.2013	ATE	1	57	24/Ø312		X224753	X224754
		09.2006	09.2007	ATE	1	57	24/Ø330	Al	X224699	X224700
		09.2006	12.2013	ATE	1	42	20/Ø300		X225367	X225368

Affectations par Marques

Vehicule application - Zuordnung nach Marke und Fahrzeuge - Applicazione per marca e veicolo - Aplicacion por marca y vehiculo



BMW



3 (E92)

330 d		09.2006	08.2008	ATE	1	57	30/Ø348		X224739	X224740
		01.2009	12.2013	ATE	1	57	24/Ø330	[A]	X224699	X224700
		09.2006	08.2008	ATE	1	44	22/Ø336		X225353	X225354
330 d xDrive		01.2009	12.2013	ATE	1	57	24/Ø330	[A]	X224699	X224700
		01.2009	12.2013	ATE	1	44	22/Ø336		X225353	X225354
330 i		09.2006	12.2013	ATE	1	57	24/Ø330	[A]	X224699	X224700
		09.2006	12.2013	ATE	1	57	30/Ø348		X224739	X224740
		09.2006	12.2013	BREMBO	6	28/ 32/ 36	24		X284159	X284160
		09.2006	12.2013	ATE	1	44	22/Ø336		X225353	X225354
330 i xDrive		09.2008	12.2013	ATE	1	57	24/Ø330	[A]	X224699	X224700
		09.2008	12.2013	ATE	1	44	22/Ø336		X225353	X225354
330 xd		09.2006	08.2008	ATE	1	57	30/Ø348		X224739	X224740
		01.2009	12.2013	ATE	1	57	24/Ø330	[A]	X224699	X224700
		09.2006	08.2008	ATE	1	44	22/Ø336		X225353	X225354
330 xi		09.2006	12.2013	ATE	1	57	24/Ø330	[A]	X224699	X224700
		09.2006	12.2013	ATE	1	44	22/Ø336		X225353	X225354
335 d		09.2006	12.2013	ATE	1	57	30/Ø348		X224739	X224740
		09.2006	12.2013	ATE	1	44	22/Ø336		X225353	X225354
335 i		09.2006	12.2013	ATE	1	57	30/Ø348		X224739	X224740
		09.2006	12.2013	ATE	1	44	22/Ø336		X225353	X225354
335 i xDrive		09.2008	12.2013	ATE	1	57	30/Ø348		X224739	X224740
		09.2008	12.2013	ATE	1	44	22/Ø336		X225353	X225354
335 xi		09.2006	12.2013	ATE	1	57	30/Ø348		X224739	X224740
		09.2006	12.2013	ATE	1	44	22/Ø336		X225353	X225354
M		03.2007	12.2013	ATE	1	46	24		X225309	X225310
		03.2007	12.2013	ATE	1	46	24		X225435	X225436

3 (E93)

318 i		03.2010	12.2013	ATE	1	54	24/Ø300	[Fe]	X224803	X224804
		03.2010	12.2013	BREMBO	6	28/ 32/ 36	24		X284159	X284160
		03.2010	12.2013	ATE	1	42	20/Ø300		X225367	X225368
320 d		03.2007	12.2011	ATE	1	57	24/Ø300	[A]	X224805	X224806
		03.2007	12.2011	ATE	1	57	24/Ø312		X224753	X224754
		03.2007	12.2011	BREMBO	6	28/ 32/ 36	24		X284159	X284160
		03.2007	12.2011	ATE	1	42	20/Ø300		X225367	X225368
320 i		01.2007	12.2013	ATE	1	57	24/Ø300	[A]	X224805	X224806
		01.2007	12.2013	ATE	1	57	24/Ø312		X224753	X224754
		01.2007	12.2013	BREMBO	6	28/ 32/ 36	24		X284159	X284160
		01.2007	12.2013	ATE	1	42	20/Ø300		X225367	X225368
325 d		03.2007	12.2013	ATE	1	57	24/Ø330	[A]	X224699	X224700
		03.2007	12.2013	BREMBO	6	28/ 32/ 36	24		X284159	X284160
		02.2010	12.2013	ATE	1	57	30/Ø348		X224739	X224740
		03.2007	12.2013	ATE	1	44	22/Ø336		X225353	X225354

X=1 : SNRA - X=2 : EAI - X=3 : SERA - X=4 : SEEAC - X=5 : NEOTO - X=6 : STARTCAR

Affectations par Marques

Vehicule application - Zuordnung nach Marke und Fahrzeuge - Applicazione per marca e veicolo - Aplicacion por marca y vehiculo



BMW



3 (E93)

325 i		10.2006	12.2013	ATE	1	57	24/Ø330		X224699	X224700
		10.2006	12.2013	BREMBO	6	28/ 32/ 36	24		X284159	X284160
		03.2007	12.2013	ATE	1	57	24/Ø300		X224805	X224806
		03.2007	12.2013	ATE	1	57	24/Ø312		X224753	X224754
		10.2006	12.2013	ATE	1	42	20/Ø300		X225367	X225368
330 d		03.2007	03.2010	ATE	1	57	30/Ø348		X224739	X224740
		01.2009	12.2013	ATE	1	57	24/Ø330		X224699	X224700
		03.2007	03.2010	ATE	1	44	22/Ø336		X225353	X225354
330 i		03.2007	12.2013	ATE	1	57	24/Ø330		X224699	X224700
		03.2007	09.2009	ATE	1	57	30/Ø348		X224739	X224740
		03.2007	12.2013	BREMBO	6	28/ 32/ 36	24		X284159	X284160
		03.2007	12.2013	ATE	1	44	22/Ø336		X225353	X225354
335 i		03.2007	12.2013	ATE	1	57	30/Ø348		X224739	X224740
		03.2007	12.2013	ATE	1	44	22/Ø336		X225353	X225354
M3		03.2007	12.2013	ATE	1	46	24		X225309	X225310
		03.2007	12.2013	ATE	1	46	24		X225435	X225436

3 (F30, F35, F80)

Tout / All / Alle / Tutti / Todos		11.2011		BOSCH	1	54	22/Ø300		X274129	X274130
		11.2011		BOSCH	1	57	24/Ø312 -330		X274135	X274136
		10.2011		BOSCH	1	42	20/Ø300		X275079	X275080

3 (F31)

Tout / All / Alle / Tutti / Todos		06.2012		BOSCH	1	54	22/Ø300		X274129	X274130
		06.2012		BOSCH	1	57	24/Ø312 -330		X274135	X274136
		06.2012		BOSCH	1	42	20/Ø300		X275079	X275080

3 (F34)

Tout / All / Alle / Tutti / Todos		03.2013		BOSCH	1	54	22/Ø300		X274129	X274130
		03.2013		BOSCH	1	57	24/Ø312 -330		X274135	X274136
		03.2013		BOSCH	1	42	20/Ø300		X275079	X275080

4 (F32, F33, F36, F82, F83)

Tout / All / Alle / Tutti / Todos		07.2013		BOSCH	1	54	22/Ø300		X274129	X274130
		07.2013		BOSCH	1	57	24/Ø312 -330		X274135	X274136
		07.2013		BOSCH	1	42	20/Ø300		X275079	X275080

5 (E12)

518		07.1974	07.1976	ATE	4	40	12,7		X224135	X224136
		07.1974	05.1981	ATE	4	40	22		X224137	X224138
520		08.1972	07.1976	ATE	4	40	12,7		X224135	X224136
		08.1972	08.1977	ATE	4	40	22		X224137	X224138
520 i		08.1972	05.1977	ATE	4	40	22		X224137	X224138
		10.1975	07.1976	ATE	4	40	12,7		X224135	X224136
520/6		09.1977	05.1981	ATE	4	40	22		X224137	X224138
525		08.1973	05.1981	ATE	4	40	22		X224137	X224138
528		01.1975	08.1977	ATE	4	40	22		X224137	X224138

X=1 : SNRA - X=2 : EAI - X=3 : SERA - X=4 : SEEC - X=5 : NEOTO - X=6 : STARTCAR

Affectations par Marques

Vehicule application - Zuordnung nach Marke und Fahrzeuge - Applicazione per marca e veicolo - Aplicacion por marca y vehiculo



BMW



5 (E12)

528 i		04.1977	08.1979	ATE	4	40	22		X224137	X224138
Tout / All / Alle / Tutti / Todos		08.1972	05.1981	ATE	2	42	9,7		X225007	X225008

5 (E28)

518		06.1981	08.1984	ATE	1	54	12,7		X224157	X224158
		06.1981	08.1984	ATE	1	57	22		X224169	X224170
518 i		09.1981	12.1987	ATE	1	54	12,7		X224157	X224158
		09.1981	12.1987	ATE	1	57	22		X224169	X224170
520 i		06.1981	12.1987	ATE	1	54	12,7		X224157	X224158
		06.1981	12.1987	ATE	1	57	22		X224169	X224170
524 d		03.1986	12.1987	ATE	1	57	22		X224169	X224170
524 td		09.1983	09.1984	ATE	1	54	12,7		X224157	X224158
		09.1983	12.1987	ATE	1	57	22		X224169	X224170
525 e		09.1981	12.1987	ATE	1	57	22		X224169	X224170
525 i		06.1981	12.1987	ATE	1	57	22		X224169	X224170
528 i		06.1981	05.1984	ATE	1	57	22		X224169	X224170
		06.1981	12.1987	ATE	1	57	25		X224159	X224160
535 i, M 535 i		01.1985	12.1987	ATE	1	57	25		X224159	X224160
M5		08.1985	12.1987	ATE	1	60	28		X224097	X224098
		08.1985	12.1987	ATE	4	40	30		X224457	X224458
		08.1985	12.1987	ATE	1	35	10		X225097	X225098
		08.1985	12.1987	ATE	1	35	19		X225103	X225104
Tout / All / Alle / Tutti / Todos		06.1981	12.1987	ATE	1	33	10		X225047	X225048

5 (E34)

518 g		11.1995	06.1996	ATE	1	60	12		X224207	X224208
		11.1995	06.1996	ATE	1	40	10	#ID: 40 / 10	X225099	X225100
518 i		08.1989	01.1997	ATE	1	60	12		X224207	X224208
		08.1989	09.1995	ATE	1	38	10	#ID: 38 / 10	X225061	X225062
		03.1993	01.1997	ATE	1	40	10	#ID: 40 / 10	X225099	X225100
520 i		01.1988	08.1991	ATE	1	60	12		X224207	X224208
		01.1988	01.1997	ATE	1	60	22		X224219	X224220
		01.1988	08.1991	ATE	1	38	10	#ID: 38 / 10	X225061	X225062
		11.1991	01.1997	ATE	1	40	10	#ID: 40 / 10	X225099	X225100
520 i 24V		09.1989	09.1995	ATE	1	60	12		X224207	X224208
		09.1989	09.1995	ATE	1	60	22		X224219	X224220
		09.1989	09.1995	ATE	1	38	10	#ID: 38 / 10	X225061	X225062
524 td		03.1988	09.1991	ATE	1	60	12		X224207	X224208
		03.1988	09.1991	ATE	1	38	10	#ID: 38 / 10	X225061	X225062
525 i		01.1988	06.1996	ATE	1	60	22		X224219	X224220
		01.1988	08.1991	ATE	1	38	10	#ID: 38 / 10	X225061	X225062
		11.1991	06.1996	ATE	1	40	10	#ID: 40 / 10	X225099	X225100
525 i 24V		09.1989	09.1995	ATE	1	60	22		X224219	X224220
		09.1989	09.1995	ATE	1	38	10	#ID: 38 / 10	X225061	X225062

X=1 : SNRA - X=2 : EAI - X=3 : SERA - X=4 : SEEAC - X=5 : NEOTO - X=6 : STARTCAR

Affectations par Marques

Vehicule application - Zuordnung nach Marke und Fahrzeuge - Applicazione per marca e veicolo - Aplicacion por marca y vehiculo



BMW



5 (E34)

525 ix		02.1992	06.1996	ATE	1	60	28/Ø302-315			X224291	X224292
		02.1992	06.1996	ATE	1	40	10	#ID: 40 / 10		X225099	X225100
525 ix 24V		10.1991	09.1995	ATE	1	60	28/Ø302-315			X224291	X224292
		10.1991	09.1995	ATE	1	38	10	#ID: 38 / 10		X225061	X225062
525 td		03.1993	01.1997	ATE	1	60	22			X224219	X224220
		04.1993	09.1995	ATE	1	60	12			X224207	X224208
		03.1993	01.1997	ATE	1	40	10	#ID: 40 / 10		X225099	X225100
		04.1993	09.1995	ATE	1	38	10	#ID: 38 / 10		X225061	X225062
525 tds		09.1991	09.1995	ATE	1	60	12			X224207	X224208
		12.1991	01.1997	ATE	1	60	22			X224219	X224220
		09.1991	09.1995	ATE	1	38	10	#ID: 38 / 10		X225061	X225062
		12.1991	01.1997	ATE	1	40	10	#ID: 40 / 10		X225099	X225100
530 i		01.1988	08.1991	ATE	1	60	22			X224219	X224220
		01.1988	08.1991	ATE	1	38	10	#ID: 38 / 10		X225061	X225062
530 i V8		09.1992	09.1995	ATE	1	60	22			X224219	X224220
		09.1992	09.1995	ATE	1	38	10	#ID: 38 / 10		X225061	X225062
		09.1992	01.1997	ATE	1	40	10	#ID: 40 / 10		X225099	X225100
535 i		01.1988	09.1995	ATE	1	60	22			X224219	X224220
		01.1988	09.1995	ATE	1	38	10	#ID: 38 / 10		X225061	X225062
540 i		09.1993	01.1997	ATE	1	60	28			X224097	X224098
		09.1993	01.1997	ATE	1	40	20			X225101	X225102
540 i V8		09.1992	09.1995	ATE	1	60	28			X224097	X224098
		09.1992	09.1995	ATE	1	40	20			X225101	X225102
M5 3.5		12.1987	12.1988	ATE	1	60	28			X224097	X224098
		12.1987	12.1988	ATE	1	38	10	#ID: 38 / 10		X225061	X225062
M5 3.6		10.1988	05.1992	ATE	1	60	28			X224097	X224098
		10.1988	05.1992	ATE	1	40	20			X225101	X225102
M5 3.6 CAT		10.1988	05.1992	ATE	1	60	28			X224097	X224098
		10.1988	05.1992	ATE	1	40	20			X225101	X225102
M5 3.8		03.1992	06.1994	ATE	1	60	28			X224097	X224098
		03.1992	01.1997	ATE	4	40/44	32			X224461	X224462
		03.1992	01.1997	ATE	1	40	20			X225181	X225182
		03.1992	06.1994	ATE	1	40	20			X225101	X225102

5 (E39)

520 d		02.2000	06.2003	ATE	1	60	22			X224443	X224444
		02.2000	06.2003	ATE	1	60	30			X224441	X224442
		02.2000	06.2003	ATE	1	40	10			X225169	X225170
		02.2000	06.2003	ATE	1	40	20			X225167	X225168
		02.2000	09.2003	ATE	1	42	20			X225283	X225284

Affectations par Marques

Vehicule application - Zuordnung nach Marke und Fahrzeuge - Applicazione per marca e veicolo - Aplicacion por marca y vehiculo



BMW



5 (E39)

520 i		01.1996	06.2003	ATE	1	60	22		X224443	X224444
		09.2000	06.2003	ATE	1	60	30		X224441	X224442
		01.1996	06.2003	ATE	1	40	10		X225169	X225170
		01.1996	06.2003	ATE	1	40	20		X225167	X225168
		01.1997	05.2004	ATE	1	42	20		X225283	X225284
523 i		11.1995	09.2000	ATE	1	60	22		X224443	X224444
		11.1995	09.2000	ATE	1	40	10		X225169	X225170
		11.1995	09.2000	ATE	1	40	20		X225167	X225168
		01.1997	09.2000	ATE	1	42	20		X225283	X225284
525 d		02.2000	06.2003	ATE	1	60	22		X224443	X224444
		02.2000	06.2003	ATE	1	60	30		X224441	X224442
		02.2000	06.2003	ATE	1	40	20		X225167	X225168
		02.2000	05.2004	ATE	1	42	20		X225283	X225284
525 i		09.2000	06.2003	ATE	1	60	22		X224443	X224444
		09.2000	06.2003	ATE	1	60	30		X224441	X224442
		09.2000	06.2003	ATE	1	40	20		X225167	X225168
		09.2000	05.2004	ATE	1	42	20		X225283	X225284
525 td		01.1997	06.2003	ATE	1	60	22		X224443	X224444
		01.1997	06.2003	ATE	1	40	10		X225169	X225170
		01.1997	06.2003	ATE	1	40	20		X225167	X225168
525 tds		01.1996	05.2004	ATE	1	60	22		X224443	X224444
		01.1996	06.2003	ATE	1	40	10		X225169	X225170
		01.1996	06.2003	ATE	1	40	20		X225167	X225168
		03.1997	05.2004	ATE	1	42	20		X225283	X225284
528 i		11.1995	09.2000	ATE	1	60	22		X224443	X224444
		11.1995	09.2000	ATE	1	40	20		X225167	X225168
		01.1997	09.2000	ATE	1	42	20		X225283	X225284
530 d		08.1998	09.2000	ATE	1	60	22		X224443	X224444
		09.2000	06.2003	ATE	1	60	30		X224441	X224442
		08.1998	06.2003	ATE	1	40	20		X225167	X225168
		08.1998	05.2004	ATE	1	42	20		X225283	X225284
530 i		09.2000	06.2003	ATE	1	60	30		X224441	X224442
		09.2000	06.2003	ATE	1	40	20		X225167	X225168
		09.2000	05.2004	ATE	1	42	20		X225283	X225284
535 i		04.1996	09.1997	ATE	1	60	22		X224443	X224444
		04.1996	06.2003	ATE	1	60	30		X224441	X224442
		04.1996	06.2003	ATE	1	40	20		X225167	X225168
540 i		04.1996	05.2004	ATE	1	60	30		X224441	X224442
		04.1996	06.2003	ATE	1	40	20		X225167	X225168
		01.1997	05.2004	ATE	1	42	20		X225283	X225284
M5		10.1998	06.2003	ATE	1	60	32		X224735	X224736
		10.1998	06.2003	ATE	1	42	20		X225365	X225366

Affectations par Marques

Vehicule application - Zuordnung nach Marke und Fahrzeuge - Applicazione per marca e veicolo - Aplicacion por marca y vehiculo



BMW



5 (E60)											
520 d		07.2005	07.2007	ATE	1	60	24/Ø310			X224629	X224630
		07.2005	07.2007	ATE	1	60	30/Ø324			X224695	X224696
		07.2005	07.2007	ATE	1	42	20/Ø320			X225323	X225324
520 i		07.2003	05.2005	ATE	1	60	24/Ø310			X224629	X224630
		07.2003	05.2005	ATE	1	60	30/Ø324			X224695	X224696
		07.2003	05.2005	ATE	1	42	20/Ø320			X225323	X225324
523 i		07.2005	02.2007	ATE	1	60	24/Ø310			X224629	X224630
		07.2005	02.2007	ATE	1	60	30/Ø324			X224695	X224696
		07.2005	02.2007	ATE	1	42	20/Ø320			X225323	X225324
525 d		06.2004	02.2007	ATE	1	60	24/Ø310			X224629	X224630
		06.2004	02.2007	ATE	1	60	30/Ø324			X224695	X224696
		01.2007	03.2010	ATE	1	60	30/Ø348			X224697	X224698
		06.2004	02.2007	ATE	1	42	20/Ø320			X225323	X225324
		01.2007	03.2010	ATE	1	46	24/Ø345			X225309	X225310
525 d xDrive		09.2008	03.2010	ATE	1	60	30/Ø324			X224767	X224768
		09.2008	03.2010	ATE	1	42	20/Ø320			X225323	X225324
525 i		09.2003	05.2005	ATE	1	60	24/Ø310			X224629	X224630
		09.2003	05.2005	ATE	1	60	30/Ø324			X224695	X224696
		01.2007	03.2010	ATE	1	60	30/Ø348			X224697	X224698
		09.2003	05.2005	ATE	1	42	20/Ø320			X225323	X225324
		01.2007	03.2010	ATE	1	46	24/Ø345			X225309	X225310
525 i xDrive		09.2008	03.2010	ATE	1	60	30/Ø324			X224767	X224768
		09.2008	03.2010	ATE	1	42	20/Ø320			X225323	X225324
525 xd		01.2007	03.2010	ATE	1	60	30/Ø324			X224767	X224768
		01.2007	03.2010	ATE	1	42	20/Ø320			X225323	X225324
525 xi		07.2005	02.2007	ATE	1	60	30/Ø324			X224767	X224768
		07.2005	02.2007	ATE	1	42	20/Ø320			X225323	X225324
530 d		07.2003	08.2005	ATE	1	60	30/Ø324			X224695	X224696
		07.2003	08.2005	ATE	1	60	30/Ø348			X224697	X224698
		07.2003	08.2005	ATE	1	42	20/Ø320			X225323	X225324
		07.2003	08.2005	ATE	1	46	24/Ø345			X225309	X225310
530 d xDrive		09.2008	03.2010	ATE	1	60	30/Ø324			X224767	X224768
		09.2008	03.2010	ATE	1	42	20/Ø320			X225323	X225324
530 i		07.2003	05.2005	ATE	1	60	30/Ø324			X224695	X224696
		07.2005	01.2009	ATE	1	60	30/Ø348			X224697	X224698
		07.2003	05.2005	ATE	1	42	20/Ø320			X225323	X225324
		07.2005	01.2009	ATE	1	46	24/Ø345			X225309	X225310
530 i xDrive		09.2008	03.2010	ATE	1	60	30/Ø324			X224767	X224768
		09.2008	03.2010	ATE	1	42	20/Ø320			X225323	X225324
530 xd		07.2005	02.2007	ATE	1	60	30/Ø324			X224767	X224768
		07.2005	02.2007	ATE	1	42	20/Ø320			X225323	X225324
530 xi		07.2005	01.2009	ATE	1	60	30/Ø324			X224767	X224768
		07.2005	01.2009	ATE	1	42	20/Ø320			X225323	X225324

X=1 : SNRA - X=2 : EAI - X=3 : SERA - X=4 : SEEAC - X=5 : NEOTO - X=6 : STARTCAR

Affectations par Marques

Vehicule application - Zuordnung nach Marke und Fahrzeuge - Applicazione per marca e veicolo - Aplicacion por marca y vehiculo



BMW



5 (E60)

535 d		09.2004	02.2007	ATE	2	42	36/Ø348		X224645	X224646
		09.2004	02.2007	ATE	1	46	24/Ø345		X225309	X225310
540 i		07.2005	03.2010	ATE	1	60	30/Ø348		X224697	X224698
		07.2005	03.2010	ATE	1	46	24/Ø345		X225309	X225310
545 i		09.2003	08.2005	ATE	1	60	30/Ø348		X224697	X224698
		09.2003	08.2005	ATE	1	46	24/Ø345		X225309	X225310
550 i		07.2005	03.2010	ATE	1	60	30/Ø348		X224697	X224698
		07.2005	03.2010	ATE	2	42	36/Ø348		X224645	X224646
		07.2005	03.2010	ATE	1	46	24/Ø345		X225309	X225310
M5		09.2004	03.2010	ATE	1	46	24/Ø345		X225309	X225310
		09.2004	03.2010	ATE	1	46	24/Ø345		X225435	X225436

5 (E61)

520 d		07.2005	07.2007	ATE	1	60	24/Ø310		X224629	X224630
		07.2005	07.2007	ATE	1	60	30/Ø324		X224695	X224696
		07.2005	07.2007	ATE	1	38	11		X225375	X225376
520 i		07.2007	08.2010	ATE	1	60	24/Ø310		X224629	X224630
		07.2007	08.2010	ATE	1	60	30/Ø324		X224695	X224696
		07.2007	08.2010	ATE	1	38	11		X225375	X225376
523 i		07.2005	12.2010	ATE	1	60	24/Ø310		X224629	X224630
		07.2005	12.2010	ATE	1	60	30/Ø324		X224695	X224696
		07.2005	12.2010	ATE	1	38	11		X225375	X225376
525 d		06.2004	12.2010	ATE	1	60	24/Ø310		X224629	X224630
		06.2004	12.2010	ATE	1	60	30/Ø324		X224695	X224696
		01.2007	05.2010	ATE	1	60	30/Ø348		X224697	X224698
		06.2004	12.2010	ATE	1	38	11		X225375	X225376
		01.2007	05.2010	ATE	1	46	24		X225363	X225364
525 d xDrive		09.2008	05.2010	ATE	1	60	30/Ø324		X224767	X224768
		09.2008	05.2010	ATE	1	38	11		X225375	X225376
525 i		06.2004	05.2005	ATE	1	60	24/Ø310		X224629	X224630
		06.2004	05.2005	ATE	1	60	30/Ø324		X224695	X224696
		01.2007	12.2010	ATE	1	60	30/Ø348		X224697	X224698
		06.2004	05.2005	ATE	1	38	11		X225375	X225376
		01.2007	12.2010	ATE	1	46	24		X225363	X225364
525 i xDrive		09.2008	03.2010	ATE	1	60	30/Ø324		X224767	X224768
		09.2008	03.2010	ATE	1	38	11		X225375	X225376
525 xd		01.2007	12.2010	ATE	1	60	30/Ø324		X224767	X224768
		01.2007	12.2010	ATE	1	38	11		X225375	X225376
525 xi		07.2005	02.2007	ATE	1	60	30/Ø324		X224767	X224768
		07.2005	02.2007	ATE	1	38	11		X225375	X225376
530 d		06.2004	08.2005	ATE	1	60	30/Ø324		X224695	X224696
		06.2004	08.2005	ATE	1	60	30/Ø348		X224697	X224698
		06.2004	08.2005	ATE	1	38	11		X225375	X225376
		06.2004	08.2005	ATE	1	46	24		X225363	X225364

X=1 : SNRA - X=2 : EAI - X=3 : SERA - X=4 : SEEC - X=5 : NEOTO - X=6 : STARTCAR

Affectations par Marques

Vehicule application - Zuordnung nach Marke und Fahrzeuge - Applicazione per marca e veicolo - Aplicacion por marca y vehiculo



BMW



5 (E61)

530 d xDrive		09.2008	03.2010	ATE	1	60	30/Ø324		X224767	X224768
		09.2008	03.2010	ATE	1	38	11		X225375	X225376
530 i		07.2005	05.2010	ATE	1	60	30/Ø324		X224695	X224696
		07.2005	05.2010	ATE	1	60	30/Ø348		X224697	X224698
		07.2005	05.2010	ATE	1	38	11		X225375	X225376
		07.2005	05.2010	ATE	1	46	24		X225363	X225364
530 i xDrive		09.2008	03.2010	ATE	1	60	30/Ø324		X224767	X224768
		09.2008	03.2010	ATE	1	38	11		X225375	X225376
530 xd		07.2005	02.2007	ATE	1	60	30/Ø324		X224767	X224768
		07.2005	02.2007	ATE	1	38	11		X225375	X225376
530 xi		07.2005	01.2009	ATE	1	60	30/Ø324		X224767	X224768
		07.2005	01.2009	ATE	1	38	11		X225375	X225376
535 d		09.2004	02.2007	ATE	2	42	36/Ø348		X224645	X224646
		09.2004	02.2007	ATE	1	46	24		X225363	X225364
545 i		06.2004	08.2005	ATE	1	60	30/Ø348		X224697	X224698
		06.2004	08.2005	ATE	1	46	24		X225363	X225364
550 i		07.2005	12.2010	ATE	1	60	30/Ø348		X224697	X224698
		07.2005	12.2010	ATE	2	42	36/Ø348		X224645	X224646
		07.2005	12.2010	ATE	1	46	24		X225363	X225364
M		02.2007	04.2010	ATE	1	46	24		X225363	X225364

5 (F07)

Tout / All / Alle / Tutti / Todos		10.2009		ATE	1	60	30		X224771	X224772
		10.2009		ATE	1	60	36		X224773	X224774

5 (F10, F18)

518 d		01.2013		ATE	1	60	24/Ø330		X224769	X224770
		01.2013		GIRL-TRW	1	44	20		X377029	X377030
520 d		03.2010		ATE	1	60	24/Ø330		X224769	X224770
		03.2010		GIRL-TRW	1	44	20		X377029	X377030
520 d xDrive		02.2013		ATE	1	60	24/Ø330		X224769	X224770
		02.2013		GIRL-TRW	1	44	20		X377029	X377030
520 i		09.2011		ATE	1	60	24/Ø330		X224769	X224770
		09.2011		GIRL-TRW	1	44	20		X377029	X377030
523 i		03.2010		ATE	1	60	24/Ø330		X224769	X224770
		03.2010		GIRL-TRW	1	44	20		X377029	X377030
525 d		03.2010	03.2011	ATE	1	60	30/Ø348		X224771	X224772
		03.2010		ATE	1	60	36		X224773	X224774
		09.2011		ATE	1	60	24/Ø330		X224769	X224770
		03.2010	06.2013	GIRL-TRW	1	44	20		X377029	X377030
		03.2010	06.2013	GIRL-TRW	1	44	24		X377037	X377038
525 d xDrive		09.2011		ATE	1	60	24/Ø330		X224769	X224770
		09.2011		ATE	1	60	30/Ø348		X224771	X224772
		09.2011		GIRL-TRW	1	44	20		X377029	X377030

X=1 : SNRA - X=2 : EAI - X=3 : SERA - X=4 : SEEAC - X=5 : NEOTO - X=6 : STARTCAR

Affectations par Marques

Vehicule application - Zuordnung nach Marke und Fahrzeuge - Applicazione per marca e veicolo - Aplicacion por marca y vehiculo

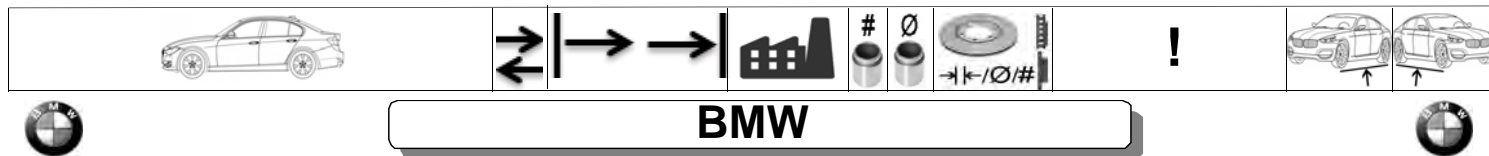

5 (F10, F18)

528 i		03.2010		ATE	1	60	24/Ø330		X224769	X224770
		03.2010		ATE	1	60	30/Ø348		X224771	X224772
		03.2010		ATE	1	60	36		X224773	X224774
		03.2010		GIRL-TRW	1	44	20		X377029	X377030
528 i xDrive		09.2011		ATE	1	60	24/Ø330		X224769	X224770
		09.2011		ATE	1	60	30/Ø348		X224771	X224772
		09.2011		ATE	1	60	36		X224773	X224774
		09.2011		GIRL-TRW	1	44	20		X377029	X377030
530 d		03.2010		ATE	1	60	30/Ø348		X224771	X224772
		03.2010		ATE	1	60	36		X224773	X224774
		03.2010		GIRL-TRW	1	44	20		X377029	X377030
		03.2010		GIRL-TRW	1	44	24		X377037	X377038
530 d xDrive		09.2011		ATE	1	60	30/Ø348		X224771	X224772
		09.2011		GIRL-TRW	1	44	20		X377029	X377030
		09.2011		GIRL-TRW	1	44	24		X377037	X377038
530 i		09.2011	07.2013	ATE	1	60	30/Ø348		X224771	X224772
		09.2011	07.2013	ATE	1	60	36		X224773	X224774
		09.2011	07.2013	GIRL-TRW	1	44	20		X377029	X377030
		09.2011	07.2013	GIRL-TRW	1	44	24		X377037	X377038
535 d		09.2010	06.2013	ATE	1	60	36		X224773	X224774
		09.2010	06.2013	GIRL-TRW	1	44	24		X377037	X377038
535 d xDrive		09.2011		ATE	1	60	36		X224773	X224774
		09.2011		GIRL-TRW	1	44	24		X377037	X377038
535 i		03.2010		ATE	1	60	36		X224773	X224774
		03.2010		GIRL-TRW	1	44	20		X377029	X377030
535 i xDrive		03.2010		ATE	1	60	36		X224773	X224774
		03.2010		GIRL-TRW	1	44	20		X377029	X377030
550 i		03.2010		ATE	1	60	36		X224773	X224774
		03.2010		GIRL-TRW	1	44	24		X377037	X377038
550 i xDrive		09.2010		ATE	1	60	36		X224773	X224774
		09.2010		GIRL-TRW	1	44	24		X377037	X377038
ActiveHybrid		09.2011		ATE	1	60	30/Ø348		X224771	X224772
		09.2011		ATE	1	60	36		X224773	X224774
		09.2011		GIRL-TRW	1	44	20		X377029	X377030
		09.2011		GIRL-TRW	1	44	24		X377037	X377038
M5 550 d xDrive		01.2012		ATE	1	60	36		X224773	X224774
		01.2012		GIRL-TRW	1	44	24		X377037	X377038

5 (F11)

518 d		01.2013		ATE	1	60	24/Ø330		X224769	X224770
		01.2013		ATE	1	60	30/Ø348		X224771	X224772
		01.2013		GIRL-TRW	1	44	20		X377029	X377030
		01.2013		GIRL-TRW	1	44	24		X377037	X377038

X=1 : SNRA - X=2 : EAI - X=3 : SERA - X=4 : SEEAC - X=5 : NEOTO - X=6 : STARTCAR

Affectations par Marques

Vehicule application - Zuordnung nach Marke und Fahrzeuge - Applicazione per marca e veicolo - Aplicacion por marca y vehiculo



BMW



5 (F11)

520 d		04.2010		ATE	1	60	24/Ø330		X224769	X224770
		09.2010		ATE	1	60	30/Ø348		X224771	X224772
		04.2010		GIRL-TRW	1	44	20		X377029	X377030
		09.2010		GIRL-TRW	1	44	24		X377037	X377038
520 d xDrive		02.2013		ATE	1	60	24/Ø330		X224769	X224770
		02.2013		ATE	1	60	30/Ø348		X224771	X224772
		02.2013		GIRL-TRW	1	44	20		X377029	X377030
		02.2013		GIRL-TRW	1	44	24		X377037	X377038
520 i		09.2011		ATE	1	60	24/Ø330		X224769	X224770
		09.2011		GIRL-TRW	1	44	20		X377029	X377030
523 i		04.2010	12.2011	ATE	1	60	24/Ø330		X224769	X224770
		04.2010	12.2011	GIRL-TRW	1	44	20		X377029	X377030
525 d		09.2010	06.2013	ATE	1	60	24/Ø330		X224769	X224770
		09.2010	06.2013	ATE	1	60	30/Ø348		X224771	X224772
		09.2010	06.2013	ATE	1	60	36		X224773	X224774
		09.2010	06.2013	GIRL-TRW	1	44	20		X377029	X377030
		09.2011		GIRL-TRW	1	44	24		X377037	X377038
525 d xDrive		09.2011		ATE	1	60	24/Ø330		X224769	X224770
		09.2011		ATE	1	60	30/Ø348		X224771	X224772
		09.2011		ATE	1	60	36		X224773	X224774
		09.2011		GIRL-TRW	1	44	20		X377029	X377030
		09.2011		GIRL-TRW	1	44	24		X377037	X377038
528 i		09.2010	06.2013	ATE	1	60	30/Ø348		X224771	X224772
		09.2011		ATE	1	60	24/Ø330		X224769	X224770
		09.2011		ATE	1	60	36		X224773	X224774
		09.2010	06.2013	GIRL-TRW	1	44	20		X377029	X377030
528 i xDrive		09.2011		ATE	1	60	24/Ø330		X224769	X224770
		09.2011		ATE	1	60	30/Ø348		X224771	X224772
		09.2011		ATE	1	60	36		X224773	X224774
		09.2011		GIRL-TRW	1	44	20		X377029	X377030
530 d		09.2010		ATE	1	60	30/Ø348		X224771	X224772
		09.2011		ATE	1	60	36		X224773	X224774
		09.2010		GIRL-TRW	1	44	20		X377029	X377030
		09.2010		GIRL-TRW	1	44	24		X377037	X377038
530 d xDrive		09.2011		ATE	1	60	30/Ø348		X224771	X224772
		09.2011		GIRL-TRW	1	44	20		X377029	X377030
		09.2011		GIRL-TRW	1	44	24		X377037	X377038
530 i		09.2011	07.2013	ATE	1	60	24/Ø330		X224769	X224770
		09.2011	07.2013	ATE	1	60	30/Ø348		X224771	X224772
		09.2011	07.2013	ATE	1	60	36		X224773	X224774
		09.2011	07.2013	GIRL-TRW	1	44	20		X377029	X377030
535 d		09.2010	06.2013	ATE	1	60	36		X224773	X224774
		09.2010	06.2013	GIRL-TRW	1	44	24		X377037	X377038

Affectations par Marques

Vehicule application - Zuordnung nach Marke und Fahrzeuge - Applicazione per marca e veicolo - Aplicacion por marca y vehiculo



BMW



5 (F11)

535 d xDrive		09.2011		ATE	1	60	36		X224773	X224774
		09.2011		GIRL-TRW	1	44	24		X377037	X377038
535 i		09.2010		ATE	1	60	36		X224773	X224774
		09.2010		GIRL-TRW	1	44	20		X377029	X377030
535 i xDrive		09.2011		ATE	1	60	30/Ø348		X224771	X224772
		09.2011		ATE	1	60	36		X224773	X224774
		09.2011		GIRL-TRW	1	44	20		X377029	X377030
		09.2011		GIRL-TRW	1	44	24		X377037	X377038
550 i		09.2010		ATE	1	60	36		X224773	X224774
		09.2010		GIRL-TRW	1	44	24		X377037	X377038
M5 550 d xDrive		01.2012		ATE	1	60	36		X224773	X224774
		01.2012		GIRL-TRW	1	44	24		X377037	X377038

6 (E24)

628 CSi		09.1979	08.1987	ATE	1	33	10		X225047	X225048
		09.1979	05.1982	ATE	2	42	19		X225033	X225034
630 CS		04.1976	08.1978	ATE	2	42	19		X225033	X225034
633 CSi		09.1978	08.1984	ATE	2	42	19		X225033	X225034
635 CSi		06.1978	09.1990	ATE	1	33	10		X225047	X225048
		06.1978	05.1982	ATE	2	42	19		X225033	X225034
M 635 CSi		03.1983	10.1989	ATE	1	35	10		X225097	X225098
		03.1983	10.1989	ATE	1	35	19		X225103	X225104
Tout / All / Alle / Tutti / Todos		04.1976	09.1990	ATE	4	40	22		X224137	X224138

6 (E63)

630 i		09.2004	12.2010	ATE	1	60	30/Ø324		X224695	X224696
		07.2007	12.2010	ATE	1	60	30/Ø348		X224697	X224698
		09.2004	12.2010	ATE	1	42	20/Ø320		X225323	X225324
		07.2007	12.2010	ATE	1	46	24/Ø345		X225309	X225310
635 d		07.2007	12.2010	ATE	2	42	36/Ø348		X224645	X224646
		07.2007	12.2010	ATE	1	46	24/Ø345		X225309	X225310
645 Ci		01.2004	12.2010	ATE	1	60	30/Ø348		X224697	X224698
		01.2004	12.2010	ATE	1	46	24/Ø345		X225309	X225310
650 i		07.2005	12.2010	ATE	1	60	30/Ø348		X224697	X224698
		07.2005	12.2010	ATE	2	42	36/Ø348		X224645	X224646
		07.2005	12.2010	ATE	1	46	24/Ø345		X225309	X225310
M6		09.2005	12.2010	ATE	1	46	24/Ø345		X225309	X225310
		09.2005	12.2010	ATE	1	46	24/Ø345		X225435	X225436

6 (E64)

630 i		09.2004	12.2010	ATE	1	60	30/Ø324		X224695	X224696
		07.2007	12.2010	ATE	1	60	30/Ø348		X224697	X224698
		09.2004	12.2010	ATE	1	42	20/Ø320		X225323	X225324
		07.2007	12.2010	ATE	1	46	24/Ø345		X225309	X225310

X=1 : SNRA - X=2 : EAI - X=3 : SERA - X=4 : SEEAC - X=5 : NEOTO - X=6 : STARTCAR

Affectations par Marques

Vehicule application - Zuordnung nach Marke und Fahrzeuge - Applicazione per marca e veicolo - Aplicacion por marca y vehiculo



BMW



6 (E64)

635 d		07.2007	12.2010	ATE	2	42	36/Ø348		X224645	X224646
		07.2007	12.2010	ATE	1	46	24/Ø345		X225309	X225310
645 Ci		04.2004	12.2010	ATE	1	60	30/Ø348		X224697	X224698
		04.2004	12.2010	ATE	1	46	24/Ø345		X225309	X225310
650 i		07.2005	12.2010	ATE	1	60	30/Ø348		X224697	X224698
		07.2005	12.2010	ATE	2	42	36/Ø348		X224645	X224646
		07.2005	12.2010	ATE	1	46	24/Ø345		X225309	X225310
M6		07.2006	12.2010	ATE	1	46	24/Ø345		X225309	X225310
		07.2006	12.2010	ATE	1	46	24/Ø345		X225435	X225436

6 (F06, F12, F13)

640 d		11.2010		ATE	1	60	36		X224773	X224774
640 d xDrive		09.2011		ATE	1	60	36		X224773	X224774
640 i		11.2010		ATE	1	60	30		X224771	X224772
		11.2010		ATE	1	60	36		X224773	X224774
640 i xDrive		01.2013		ATE	1	60	30		X224771	X224772
		01.2013		ATE	1	60	36		X224773	X224774
650 i		11.2010		ATE	1	60	36		X224773	X224774
650 i xDrive		06.2011		ATE	1	60	36		X224773	X224774
Tout / All / Alle / Tutti / Todos		11.2010		GIRL-TRW	1	44	24		X377037	X377038

7 (E23)

728		05.1977	08.1979	ATE	4	40	22		X224141	X224142
728 i		07.1978	09.1982	ATE	4	40	22		X224141	X224142
		10.1982	08.1986	ATE	4	40	25		X224117	X224118
730		05.1977	08.1979	ATE	4	40	22		X224141	X224142
732 i		09.1979	09.1982	ATE	4	40	22		X224141	X224142
		10.1982	08.1986	ATE	4	40	25		X224117	X224118
733 i		05.1977	08.1979	ATE	4	40	22		X224141	X224142
735 i		09.1979	09.1982	ATE	4	40	22		X224141	X224142
		10.1982	08.1986	ATE	4	40	25		X224117	X224118
745 i		05.1983	08.1986	ATE	4	40	25		X224117	X224118
Tout / All / Alle / Tutti / Todos		05.1977	08.1986	ATE	1	33	10		X225047	X225048
		05.1977	08.1986	ATE	2	33	10		X225043	X225044

7 (E32)

730 i,iL		12.1986	09.1994	ATE	1	60	22		X224219	X224220
		12.1986	11.1987	ATE	1	60	28		X224097	X224098
		12.1986	09.1994	ATE	1	38	10	#ID: 38 / 10	X225061	X225062
		12.1986	11.1987	ATE	1	38	12		X225077	X225078
730 i,iL V8		04.1992	09.1994	ATE	1	60	22		X224219	X224220
		04.1992	09.1994	ATE	1	38	10	#ID: 38 / 10	X225061	X225062
735 i,iL		09.1986	09.1992	ATE	1	60	28		X224097	X224098
		09.1986	09.1992	ATE	1	38	12		X225077	X225078

X=1 : SNRA - X=2 : EAI - X=3 : SERA - X=4 : SEEAC - X=5 : NEOTO - X=6 : STARTCAR

Affectations par Marques

Vehicule application - Zuordnung nach Marke und Fahrzeuge - Applicazione per marca e veicolo - Aplicacion por marca y vehiculo



BMW



7 (E32)

740 i,iL V8		04.1992	09.1994	ATE	1	60	28		X224097	X224098
		04.1992	09.1994	ATE	1	40	20		X225101	X225102
750 i,iL V12		09.1987	09.1994	ATE	1	60	28		X224097	X224098
		09.1987	09.1994	ATE	4	40/44	28/30		X224459	X224460
		09.1987	01.1990	ATE	1	38	20		X225095	X225096
		09.1987	09.1994	ATE	1	40	20		X225101	X225102

7 (E38)

725 tds		04.1996	05.2000	BREMBO	4	40/44	28		X284057	X284058
		04.1996	05.2000	ATE	1	40	12		X225179	X225180
728 i,iL		08.1995	11.2001	BREMBO	4	40/44	28		X284057	X284058
		08.1995	11.2001	ATE	1	40	12		X225179	X225180
730 d		08.1998	08.1999	BREMBO	4	40/44	28		X284057	X284058
		08.1998	08.1999	ATE	1	40	12		X225179	X225180
730 i,iL		10.1994	11.2001	BREMBO	4	40/44	28		X284057	X284058
		10.1994	11.2001	ATE	1	40	12		X225179	X225180
735 i,iL		01.1996	11.2001	BREMBO	4	40/44	28		X284057	X284058
		01.1996	11.2001	ATE	1	40	12		X225179	X225180
740 d		05.1999	11.2001	ATE	2	42	32		X224499	X224500
		05.1999	11.2001	ATE	1	40	20		X225189	X225190
740 i,iL		10.1994	11.2001	ATE	1	60	30		X224441	X224442
		10.1994	11.2001	ATE	1	40	12		X225179	X225180
750 i,iL		12.1994	02.2001	ATE	2	42	32		X224499	X224500
		12.1994	02.2001	ATE	1	40	20		X225189	X225190

7 (E65, E66, E67)

730 d		10.2002	12.2009	ATE	1	60	30/Ø324		X224695	X224696
		10.2002	12.2009	ATE	1	60	30/Ø348		X224697	X224698
		10.2002	12.2009	ATE	1	46	20/Ø324		X225393	X225394
		10.2002	12.2009	ATE	1	46	24/Ø345		X225309	X225310
730 i,Li		03.2003	02.2005	ATE	1	60	30/Ø324		X224695	X224696
		03.2003	02.2005	ATE	1	46	20/Ø324		X225393	X225394
730 Ld		07.2005	08.2008	ATE	1	60	30/Ø348		X224697	X224698
		07.2005	08.2008	ATE	1	46	24/Ø345		X225309	X225310
735 i,Li		11.2001	12.2009	ATE	1	60	30/Ø324		X224695	X224696
		11.2001	12.2009	ATE	1	46	20/Ø324		X225393	X225394
740 d		10.2002	12.2009	ATE	1	60	30/Ø348		X224697	X224698
		10.2002	12.2009	ATE	1	46	24/Ø345		X225309	X225310
740 i,Li		07.2005	03.2007	ATE	1	60	30/Ø324		X224695	X224696
		07.2005	12.2009	ATE	1	60	30/Ø348		X224697	X224698
		07.2005	03.2007	ATE	1	46	20/Ø324		X225393	X225394
		07.2005	12.2009	ATE	1	46	24/Ø345		X225309	X225310
745 d		03.2005	12.2009	ATE	1	46	24/Ø345		X225309	X225310

X=1 : SNRA - X=2 : EAI - X=3 : SERA - X=4 : SEEAC - X=5 : NEOTO - X=6 : STARTCAR

Affectations par Marques

Vehicule application - Zuordnung nach Marke und Fahrzeuge - Applicazione per marca e veicolo - Aplicacion por marca y vehiculo



BMW



7 (E65, E66, E67)

745 i,Li		11.2001	02.2005	ATE	1	60	30/Ø348		X224697	X224698
		11.2001	02.2005	ATE	1	46	24/Ø345		X225309	X225310
750 i,Li		07.2005	12.2009	ATE	1	60	30/Ø348		X224697	X224698
		07.2005	12.2009	ATE	2	42	36/Ø348		X224645	X224646
		07.2005	12.2009	ATE	1	46	24/Ø345		X225309	X225310
760 i		11.2001	12.2009	ATE	1	60	30/Ø348		X224697	X224698
		11.2001	12.2009	ATE	2	42	36/Ø348		X224645	X224646
		11.2001	12.2009	ATE	1	46	24/Ø345		X225309	X225310
760 i,Li		01.2003	12.2009	ATE	1	60	30/Ø348		X224697	X224698
		01.2003	12.2009	ATE	2	42	36/Ø348		X224645	X224646
		01.2003	12.2009	ATE	1	46	24/Ø345		X225309	X225310

7 (F01, F02, F03, F04)

730 d		10.2008	12.2015	ATE	1	60	30		X224771	X224772
		10.2008	03.2011	ATE	1	60	36		X224773	X224774
730 d xDrive		07.2012	08.2015	ATE	1	60	36		X224773	X224774
730 i		06.2008	12.2015	ATE	1	60	30		X224771	X224772
		06.2008	12.2015	ATE	1	60	36		X224773	X224774
740 d		09.2009	06.2012	ATE	1	60	36		X224773	X224774
740 d xDrive		09.2009	12.2015	ATE	1	60	36		X224773	X224774
740 i		10.2008	08.2015	ATE	1	60	36		X224773	X224774
740 i xDrive		07.2012	08.2015	ATE	1	60	36		X224773	X224774
750 d xDrive		07.2012	08.2015	ATE	1	60	36		X224773	X224774
750 i		10.2008	08.2015	ATE	1	60	36		X224773	X224774
750 i xDrive		09.2009	06.2012	ATE	1	60	36		X224773	X224774
ActiveHybrid		10.2010	08.2015	ATE	1	60	36		X224773	X224774

8 (E31)

840 Ci		01.1996	12.1999	BREMBO	4	40/44	30		X284013	X284014
		01.1996	12.1999	ATE	1	40	12		X225081	X225082
840 i		02.1993	02.1996	BREMBO	4	40/44	30		X284013	X284014
		02.1993	02.1996	ATE	1	40	12		X225081	X225082
850 Ci		09.1994	12.1999	ATE	1	60	30		X224205	X224206
		09.1994	12.1999	ATE	1	40	12		X225081	X225082
850 CSi		04.1993	12.1996	ATE	4	40/44	32		X224461	X224462
		04.1993	12.1996	ATE	1	40	20		X225093	X225094
850 i,Ci		04.1990	10.1994	ATE	1	60	30		X224205	X224206
		04.1990	10.1994	BREMBO	4	40/44	30		X284013	X284014
		04.1990	10.1994	ATE	1	40	12		X225081	X225082

2000-3.2 (E9)

2.5 CS		09.1974	03.1976	ATE	2	42	9,5		X224011	X224012
2800 CS		01.1969	04.1971	ATE	2	42	9,5		X224011	X224012
3.0 CS		05.1971	03.1976	ATE	4	40	22		X224077	X224078
3.0 Csi		07.1971	03.1976	ATE	4	40	22		X224077	X224078

X=1 : SNRA - X=2 : EAI - X=3 : SERA - X=4 : SEEC - X=5 : NEOTO - X=6 : STARTCAR

Affectations par Marques

Vehicule application - Zuordnung nach Marke und Fahrzeuge - Applicazione per marca e veicolo - Aplicacion por marca y vehiculo



BMW



2000-3.2 (E9)

3.2 CSL		01.1974	12.1975	ATE	4	40	22		X224077	X224078
Tout / All / Alle / Tutti / Todos		05.1971	03.1976	ATE	2	42	19		X225033	X225034

2500-3.3 (E3)

Tout / All / Alle / Tutti / Todos		10.1968	12.1977	ATE	4	40	12,7		X224024	X224023
		10.1968	12.1977	ATE	4	40	22		X224077	X224078
		10.1968	12.1977	ATE	2	42	9,7		X225007	X225008

X1 (E84)

sDrive 16 d		04.2012		ATE	1	57	24/Ø312		X224753	X224754
		04.2012		ATE	1	42	20		X225367	X225368
sDrive 16 i		03.2013		ATE	1	57	24/Ø312		X224753	X224754
		03.2013		ATE	1	42	20		X225367	X225368
sDrive 18 d		03.2009		ATE	1	57	24/Ø312		X224753	X224754
		03.2009		ATE	1	42	20		X225367	X225368
sDrive 18 i		03.2009		ATE	1	57	24/Ø312		X224753	X224754
		03.2009		ATE	1	42	20		X225367	X225368
sDrive 20 d		10.2009		ATE	1	57	24/Ø312		X224753	X224754
		10.2009		ATE	1	42	20		X225367	X225368
sDrive 20 i		09.2011		ATE	1	57	24/Ø312		X224753	X224754
		09.2011		ATE	1	42	20		X225367	X225368
xDrive 18 d		03.2009		ATE	1	57	24/Ø312		X224753	X224754
		03.2009		ATE	1	42	20		X225367	X225368
xDrive 20 d		10.2009		ATE	1	57	24/Ø312		X224753	X224754
		10.2009		ATE	1	42	20		X225367	X225368
xDrive 20 i		09.2011		ATE	1	57	24/Ø312		X224753	X224754
		09.2011		ATE	1	42	20		X225367	X225368
xDrive 23 d		10.2009		ATE	1	57	24/Ø330		X224699	X224700
		10.2009		ATE	1	42	20		X225367	X225368
xDrive 25 d		10.2009		ATE	1	57	24/Ø312		X224753	X224754
		10.2009		ATE	1	42	20		X225367	X225368
xDrive 25 i		01.2010	12.2012	ATE	1	57	24/Ø330		X224699	X224700
		01.2010	12.2012	ATE	1	42	20		X225367	X225368
xDrive 28 i		10.2009		ATE	1	57	30/Ø348		X224739	X224740
		04.2011		ATE	1	57	24/Ø330		X224699	X224700
		10.2009		ATE	1	44	22		X225353	X225354
		04.2011		ATE	1	42	20		X225367	X225368

X3 (E83)

2.0 d		10.2004		ATE	1	57	25		X224555	X224556
2.0 i		07.2005		ATE	1	57	25		X224555	X224556
2.5 i		01.2004		ATE	1	57	25		X224555	X224556
2.5 si		09.2006		ATE	1	57	25		X224555	X224556
3.0 d		01.2004		ATE	1	57	25		X224555	X224556
3.0 i xDrive		01.2004		ATE	1	57	25		X224555	X224556

X=1 : SNRA - X=2 : EAI - X=3 : SERA - X=4 : SEEC - X=5 : NEOTO - X=6 : STARTCAR

Affectations par Marques

Vehicule application - Zuordnung nach Marke und Fahrzeuge - Applicazione per marca e veicolo - Aplicacion por marca y vehiculo

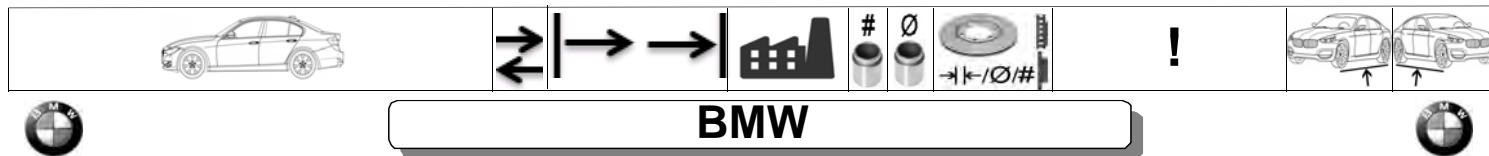

BMW

X3 (E83)

3.0 sd		09.2006		ATE	1	60	30		X224441	X224442
3.0 si		09.2006		ATE	1	57	25		X224555	X224556
Tout / All / Alle / Tutti / Todos		01.2004		ATE	1	42	22		X225271	X225272
xDrive 18 d		09.2008		ATE	1	57	25		X224555	X224556
xDrive 20 d		09.2008		ATE	1	57	25		X224555	X224556
xDrive 20 i		09.2008		ATE	1	57	25		X224555	X224556
xDrive 25 i		09.2008		ATE	1	57	25		X224555	X224556
xDrive 30 d		09.2008		ATE	1	57	25		X224555	X224556
xDrive 30 i		09.2008		ATE	1	57	25		X224555	X224556
xDrive 35 d		09.2008		ATE	1	60	30		X224441	X224442

X3 (F25)

Tout / All / Alle / Tutti / Todos		09.2010		GIRL-TRW	1	42	20/Ø330		X377071	X377072
-----------------------------------	--	---------	--	----------	---	----	---------	--	---------	---------

X4 (F26)

Tout / All / Alle / Tutti / Todos		04.2014		GIRL-TRW	1	42	20/Ø330		X377071	X377072
-----------------------------------	--	---------	--	----------	---	----	---------	--	---------	---------

X5 (E53)

3.0 d		05.2001	09.2003	ATE	1	60	30		X224441	X224442
3.0 i		05.2000	12.2006	ATE	1	60	30		X224441	X224442
4.4 i		05.2000	09.2003	ATE	1	60	30		X224441	X224442
		05.2000	09.2003	ATE	2	42	36		X224909	X224910
4.6 is		02.2002	12.2006	ATE	2	42	36		X224909	X224910
4.8 is		04.2004	12.2006	ATE	2	42	36		X224909	X224910
Tout / All / Alle / Tutti / Todos		05.2000	12.2006	ATE	1	42	12		X225307	X225308

X5 (E70)

3.0 d		02.2007	09.2008	ATE	1	60	30		X224811	X224812
		02.2007	09.2008	ATE	1	44	20/Ø320		X225399	X225400
		02.2007	09.2008	ATE	1	44	24/Ø345		X225433	X225434
3.0 sd		09.2007	08.2008	ATE	2	42	36		X224823	X224824
		09.2007	08.2008	ATE	1	44	24/Ø345		X225433	X225434
3.0 si		02.2007	09.2008	ATE	1	60	30		X224811	X224812
		02.2007	09.2008	ATE	1	44	20/Ø320		X225399	X225400
4.8 i xDrive		02.2007	09.2008	ATE	1	60	30		X224811	X224812
		02.2007	09.2008	ATE	2	42	36		X224823	X224824
		02.2007	09.2008	ATE	1	44	24/Ø345		X225433	X225434
M 50 d		08.2011	06.2013	ATE	1	44	24/Ø345		X225433	X225434
xDrive 30 d		09.2008	06.2012	ATE	1	60	30		X224811	X224812
		09.2008	06.2012	ATE	1	44	20/Ø320		X225399	X225400
xDrive 30 i		09.2008	03.2010	ATE	1	60	30		X224811	X224812
		09.2008	03.2010	ATE	1	44	20/Ø320		X225399	X225400
xDrive 35 d		09.2008	06.2010	ATE	1	60	30		X224811	X224812
		09.2008	06.2013	ATE	1	44	20/Ø320		X225399	X225400
		09.2008	09.2009	ATE	1	44	24/Ø345		X225433	X225434

X=1 : SNRA - X=2 : EAI - X=3 : SERA - X=4 : SEEAC - X=5 : NEOTO - X=6 : STARTCAR

Affectations par Marques

Vehicule application - Zuordnung nach Marke und Fahrzeuge - Applicazione per marca e veicolo - Aplicacion por marca y vehiculo



BMW



X5 (E70)

xDrive 35 i		09.2010	06.2013	ATE	1	60	30		X224811	X224812
		09.2010	06.2013	ATE	1	44	20/Ø320		X225399	X225400
xDrive 40 d		09.2010	06.2013	ATE	1	60	30		X224811	X224812
		09.2010	06.2013	ATE	1	44	20/Ø320		X225399	X225400
xDrive 48 i		09.2008	06.2013	ATE	1	60	30		X224811	X224812
		09.2008	06.2013	ATE	2	42	36		X224823	X224824
		09.2008	06.2013	ATE	1	44	24/Ø345		X225433	X225434
xDrive 50 i		06.2010	06.2013	ATE	2	42	36		X224823	X224824
		06.2010	06.2013	ATE	1	44	24/Ø345		X225433	X225434

X5 (F15, F85)

M5 50 d		11.2012		ATE	1	44	24/Ø345		X225433	X225434
sDrive 25 d		01.2013		ATE	1	60	30		X224811	X224812
		01.2013		ATE	1	44	20/Ø320		X225399	X225400
xDrive 25 d		01.2013		ATE	1	60	30		X224811	X224812
		01.2013		ATE	1	44	20/Ø320		X225399	X225400
xDrive 30 d		11.2012		ATE	1	60	30		X224811	X224812
		11.2012		ATE	1	44	20/Ø320		X225399	X225400
xDrive 35 i		01.2013		ATE	1	60	30		X224811	X224812
		01.2013		ATE	1	44	20/Ø320		X225399	X225400
		01.2013		ATE	1	44	24/Ø345		X225433	X225434
xDrive 40 d		12.2013		ATE	1	44	24/Ø345		X225433	X225434
xDrive 50 i		11.2012		ATE	2	42	36		X224823	X224824
		11.2012		ATE	1	44	24/Ø345		X225433	X225434

X6 (E71, E72)

30 d		05.2008	06.2014	ATE	1	60	30		X224811	X224812
		05.2008	06.2014	ATE	1	44	20/Ø320		X225399	X225400
		05.2008	06.2014	ATE	1	44	24/Ø345		X225433	X225434
35 d		05.2008	06.2014	ATE	2	42	36		X224823	X224824
		05.2008	06.2014	ATE	1	44	24/Ø345		X225433	X225434
35 i		05.2008	06.2014	ATE	1	60	30		X224811	X224812
		05.2008	06.2014	ATE	2	42	36		X224823	X224824
		05.2008	06.2014	ATE	1	44	24/Ø345		X225433	X225434
50 i		05.2008	06.2014	ATE	2	42	36		X224823	X224824
		05.2008	06.2014	ATE	1	44	24/Ø345		X225433	X225434
ActiveHybrid		10.2010	06.2014	ATE	1	44	24/Ø345		X225433	X225434
M6 50 d		08.2011	06.2014	ATE	1	44	24/Ø345		X225433	X225434
xDrive 30 d		09.2008	06.2014	ATE	1	60	30		X224811	X224812
		09.2008	06.2014	ATE	1	44	20/Ø320		X225399	X225400
		09.2008	06.2014	ATE	1	44	24/Ø345		X225433	X225434

Affectations par Marques

Vehicule application - Zuordnung nach Marke und Fahrzeuge - Applicazione per marca e veicolo - Aplicacion por marca y vehiculo

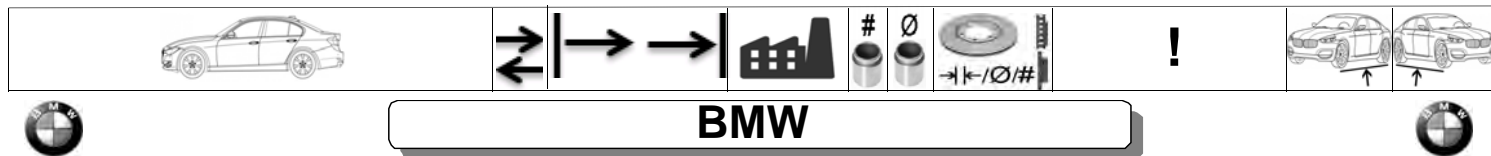

X6 (E71, E72)

xDrive 35 d		09.2008	06.2014	ATE	1	60	30		X224811	X224812
		09.2008	06.2014	ATE	2	42	36		X224823	X224824
		09.2008	06.2014	ATE	1	44	20/Ø320		X225399	X225400
		09.2008	10.2009	ATE	1	44	24/Ø345		X225433	X225434
xDrive 35 i		09.2008	06.2014	ATE	1	60	30		X224811	X224812
		09.2008	06.2014	ATE	2	42	36		X224823	X224824
		09.2008	06.2014	ATE	1	44	20/Ø320		X225399	X225400
		09.2008	10.2009	ATE	1	44	24/Ø345		X225433	X225434
xDrive 40 d		10.2010	06.2014	ATE	1	60	30		X224811	X224812
		10.2010	06.2014	ATE	1	44	20/Ø320		X225399	X225400
xDrive 50 i		09.2008	06.2014	ATE	2	42	36		X224823	X224824
		09.2008	06.2014	ATE	1	44	24/Ø345		X225433	X225434

Z1

2.5		06.1988	06.1991	ATE	1	48	22		X224199	X224200
		06.1988	06.1991	GIRL-TRW	1	48	22		X374017	X374018
Tout / All / Alle / Tutti / Todos		06.1988		ATE	1	36	10		X225107	X225108

Z3 (E36)

1.8		10.1995	10.1998	ATE	1	54	12		X224261	X224262
1.9		10.1995	01.2003	ATE	1	54	12		X224261	X224262
2.0		04.1999	07.2000	ATE	1	54	22		X224263	X224264
2.2		08.2000	01.2003	ATE	1	54	22		X224263	X224264
2.8		01.1996	09.1998	ATE	1	54	22		X224263	X224264
3.0		06.2000	07.2002	ATE	1	54	22		X224263	X224264
M3		03.1997	01.2003	ATE	1	60	28/Ø302-315		X224291	X224292
		03.1997	01.2003	ATE	1	40	20		X225171	X225172
Tout / All / Alle / Tutti / Todos		10.1995	01.2003	ATE	1	36	10		X225267	X225268

Z4 (E85)

2.0 i		04.2005	12.2009	ATE	1	54	22		X224263	X224264
		04.2005	12.2009	ATE	1	40	10		X225217	X225218
2.2 i		10.2003	12.2009	ATE	1	54	22		X224263	X224264
		10.2003	12.2009	ATE	1	40	10		X225217	X225218
2.5 i		02.2003	12.2009	ATE	1	54	22		X224263	X224264
		02.2003	12.2009	ATE	1	40	10		X225217	X225218
2.5 si		01.2006	12.2009	ATE	1	54	22		X224263	X224264
		01.2006	12.2009	ATE	1	40	19		X225209	X225210
3.0 i		02.2003	12.2009	ATE	1	54	22		X224263	X224264
		02.2003	12.2009	ATE	1	40	19		X225209	X225210
3.0 si		01.2006	12.2009	ATE	1	57	25		X224555	X224556
		01.2006	12.2009	ATE	1	40	19		X225209	X225210
M4		03.2006	12.2009	ATE	1	60	28		X224849	X224850
		03.2006	12.2009	ATE	1	46	20		X225421	X225422

Affectations par Marques

Vehicule application - Zuordnung nach Marke und Fahrzeuge - Applicazione per marca e veicolo - Aplicacion por marca y vehiculo



BMW



Z4 (E86)

3.0 si		03.2006	01.2009	ATE	1	57	25			X224555	X224556
		03.2006	01.2009	ATE	1	40	19			X225209	X225210
M4		03.2006	01.2009	ATE	1	60	28			X224849	X224850
		03.2006	01.2009	ATE	1	46	20			X225421	X225422

Z4 (E89)

sDrive 18 i		04.2013		ATE	1	57	24/Ø300	Al		X224805	X224806
		04.2013		ATE	1	57	24/Ø312	Fe		X224753	X224754
sDrive 20 i		09.2011		ATE	1	57	24/Ø300	Al		X224805	X224806
		09.2011		ATE	1	57	24/Ø312	Fe		X224753	X224754
sDrive 23 i		05.2009		ATE	1	57	24/Ø300	Al		X224805	X224806
		05.2009		ATE	1	57	24/Ø312	Fe		X224753	X224754
sDrive 28 i		09.2011		ATE	1	57	24/Ø330	Al		X224699	X224700
sDrive 30 i		05.2009		ATE	1	57	24/Ø330	Al		X224699	X224700
sDrive 35 i		05.2009		ATE	1	57	30/Ø348			X224739	X224740
sDrive 35 is		09.2010		ATE	1	57	30/Ø348			X224739	X224740
Tout / All / Alle / Tutti / Todos		05.2009		GIRL-TRW	1	42	20/Ø300	Al		X377075	X377076



BUICK



REGAL Without susp. Sport

Tout / All / Alle / Tutti / Todos		01.1989	12.1991	K/H	1	35				X795005	X795006
-----------------------------------	--	---------	---------	-----	---	----	--	--	--	---------	---------

SKYHAWK

Tout / All / Alle / Tutti / Todos		01.1982	12.1984	K/H	1	57				X794103	X794104
		01.1985	12.1989	K/H	1	57				X794001	X794002

SKYLARK

Tout / All / Alle / Tutti / Todos		01.1975	12.1976	K/H	1					X794005	X794006
		01.1977	12.1979	K/H	1					X794003	X794004
		01.1980	12.1984	K/H	1	57				X794103	X794104
		01.1985	12.1985	K/H	1	57				X794001	X794002



CADILLAC



ELDORADO

ELDORADO		01.1969	12.1978	K/H	1	74,6			2"15 / 16	X794047	X794048
		01.1976	12.1978	K/H	1	63,5			2"1 / 2	X795017	X795018
		01.1980	12.1985	K/H	1	54			2"1 / 8	X795003	X795004
		01.1986	12.1991	K/H	1	38,1			1"1 / 2	X795023	X795024

ESCALADE

Tout / All / Alle / Tutti / Todos		01.2002	12.2006	PBR	2	45				X595003	X595004
-----------------------------------	--	---------	---------	-----	---	----	--	--	--	---------	---------

Affectations par Marques

Vehicule application - Zuordnung nach Marke und Fahrzeuge - Applicazione per marca e veicolo - Aplicacion por marca y vehiculo



CADILLAC



SEVILLE											
SEVILLE 2"1/2		01.1980	12.1980	K/H	1	63,5				X794095	X794096
		01.1982	12.1985	K/H	1	63,5				X794095	X794096
		01.1992	12.1993	K/H	1	63,5				X794021	X794022
		01.1994	12.1996	K/H	1	63,5				X794017	X794018
		01.1977	12.1978	K/H	1	63,5				X795011	X795012
		01.1979	12.1979	K/H	1	63,5				X795029	X795030
SEVILLE 2"1/8		01.1980	12.1985	K/H	1	54				X795003	X795004
SEVILLE 2"15/16		01.1978	12.1978	K/H	1	74,6				X794003	X794004
		01.1979	12.1979	K/H	1	74,6				X794003	X794004
Tout / All / Alle / Tutti / Todos		01.1992	12.1996	AKE	1	38				X165179	X165180



CARBODIES



FX FAIRWAY											
2.7 TD		01.1987	12.1996	LOCK	4	41,3	24			X464109	X464110



CHEVROLET



ASTRA											
2.0		03.1999	12.2011	DAC	1	32	10			X325001	X325002
		03.1999	12.2011	DAC	1	32	10			X325003	X325004
Tout / All / Alle / Tutti / Todos		03.1999		DAC	1	54	24			X324001	X324002

AVEO (T200)											
Tout / All / Alle / Tutti / Todos		01.2004	05.2008	DAC	1	52	20			X324009	X324010

AVEO (T250, T255)											
Tout / All / Alle / Tutti / Todos		03.2006		DAC	1	52	20			X324009	X324010

AVEO (T300)											
Tout / All / Alle / Tutti / Todos		03.2011		BOSCH	1	60	26/Ø276			X274105	X274106
		03.2011		DAC	1	54	20/Ø236			X324021	X324022

CAPTIVA (C100, C140)											
Tout / All / Alle / Tutti / Todos		06.2006		MANDO	2	45	29			X484051	X484052
		06.2006		MANDO	1	40	20			X485019	X485020

CRUZE (J300/J305/J308)											
Tout / All / Alle / Tutti / Todos		05.2009		BOSCH	1	60	26/Ø276			X274105	X274106
		05.2009		BOSCH	1	60	26/Ø300			X274107	X274108
		05.2009		ATE	1	38	12/Ø268 -292			X225405	X225406
		05.2009		ATE	1	38	12/Ø268 -292			X225407	X225408

EPICA (KL1_)											
Tout / All / Alle / Tutti / Todos		06.2006		DAC	1	57	24			X324017	X324018
		01.2005		DAC	1	35	12			X325007	X325008

EVANDA											
Tout / All / Alle / Tutti / Todos		03.2005		DAC	1	57	24			X324011	X324012
		03.2005		DAC	1	35	12			X325007	X325008

X=1 : SNRA - X=2 : EAI - X=3 : SERA - X=4 : SEEC - X=5 : NEOTO - X=6 : STARTCAR

Affectations par Marques

Vehicule application - Zuordnung nach Marke und Fahrzeuge - Applicazione per marca e veicolo - Aplicacion por marca y vehiculo



CHEVROLET



KALOS

Tout / All / Alle / Tutti / Todos		03.2005		DAC	1	52	20		X324009	X324010
-----------------------------------	--	---------	--	-----	---	----	----	--	---------	---------

LACETTI

Tout / All / Alle / Tutti / Todos		03.2005		DAC	1	54	24		X324001	X324002
		03.2005		DAC	1	32	10		X325005	X325006

LANOS

1.4		11.2005	12.2010	ATE	1	48	20		X224195	X224196
1.6 16V		11.2005	12.2010	ATE	1	52	24		X224045	X224046

MATIZ (M200, M250)

Tout / All / Alle / Tutti / Todos		03.2005		DAC	1	48	12,6		X324013	X324014
		03.2005		DAC	1	48	12,6		X324015	X324016

NUBIRA

Tout / All / Alle / Tutti / Todos		01.2005		DAC	1	54	24		X324001	X324002
		01.2005		DAC	1	32	10		X325005	X325006

ORLANDO (J309)

Tout / All / Alle / Tutti / Todos		02.2011		BOSCH	1	60	26/Ø300		X274107	X274108
-----------------------------------	--	---------	--	-------	---	----	---------	--	---------	---------

REZZO

Tout / All / Alle / Tutti / Todos		03.2005		DAC	1	57	24		X324011	X324012
-----------------------------------	--	---------	--	-----	---	----	----	--	---------	---------

SPARK

Tout / All / Alle / Tutti / Todos		05.2005		DAC	1	48	12,6		X324013	X324014
		05.2005		DAC	1	48	12,6		X324015	X324016

SPARK (M300)

Tout / All / Alle / Tutti / Todos		03.2010		DAC	1	52	20		X324019	X324020
-----------------------------------	--	---------	--	-----	---	----	----	--	---------	---------

TRAX

Tout / All / Alle / Tutti / Todos		12.2012		BOSCH	1	60	26/Ø300		X274107	X274108
-----------------------------------	--	---------	--	-------	---	----	---------	--	---------	---------

VECTRA

2.0		03.1996	04.1998	DAC	1	32	10		X325001	X325002
		03.1996	04.1998	DAC	1	32	10		X325003	X325004
Tout / All / Alle / Tutti / Todos		03.1996	04.1998	DAC	1	54	24		X324001	X324002

VOLT

Tout / All / Alle / Tutti / Todos		11.2011		BOSCH	1	60	26/Ø300		X274107	X274108
-----------------------------------	--	---------	--	-------	---	----	---------	--	---------	---------



CHRYSLER



300 C (LX)

SRT8		09.2004	11.2012	BREMBO	4	44			X284167	X284168
		09.2004	11.2012	BREMBO	4	28/32			X285101	X285102
Tout / All / Alle / Tutti / Todos		09.2004	11.2012	PBR	1	60	28/Ø320		X594025	X594026
		09.2004	11.2012	PBR	2	42	28/Ø345		X594011	X594012

300 M (LR)

Tout / All / Alle / Tutti / Todos		07.1998		K/H	1	60	24		X404005	X404006
-----------------------------------	--	---------	--	-----	---	----	----	--	---------	---------

X=1 : SNRA - X=2 : EAI - X=3 : SERA - X=4 : SEEAC - X=5 : NEOTO - X=6 : STARTCAR

Affectations par Marques

Vehicule application - Zuordnung nach Marke und Fahrzeuge - Applicazione per marca e veicolo - Aplicacion por marca y vehiculo



CHRYSLER

CHRYSLER

CHRYSLER

CONCORDE

Tout / All / Alle / Tutti / Todos		10.1997		K/H	1	60	24		X404005	X404006
-----------------------------------	--	---------	--	-----	---	----	----	--	---------	---------

GRAND VOYAGER V (RT)

Tout / All / Alle / Tutti / Todos		10.2007		GIRL-TRW	1	66	28		X374729	X374730
		10.2007		GIRL-TRW	1	66	28		X374731	X374732
		10.2007		GIRL-TRW	1	43	12		X375451	X375452

PT CRUISER

Tout / All / Alle / Tutti / Todos		06.2000		GIRL-TRW	1	57	23		X374617	X374618
		06.2000		K/H	1	36	9		X405001	X405002

SEBRING (JS)

Tout / All / Alle / Tutti / Todos		07.2007	12.2010	AKE	1	57	26		X164317	X164318
		07.2007	12.2010	AKE	1	35	10/Ø262		X165193	X165194
		07.2007	12.2010	AKE	1	35	10/Ø302		X165187	X165188

VOYAGER II (ES)

Tout / All / Alle / Tutti / Todos		01.1991	09.1995	K/H	1	60	24/Ø260		X404001	X404002
		01.1991	09.1995	K/H	1	60	24/Ø282		X404003	X404004

VOYAGER III (GS)

Tout / All / Alle / Tutti / Todos		01.1995		K/H	1	60	24		X404005	X404006
		01.1995		ATE	1	42	12,5		X225247	X225248

VOYAGER IV (RG, RS)

2.4		02.2000	12.2008	ATE	1	66	28/Ø281		X224593	X224594
		02.2000	12.2008	ATE	1	66	28/Ø302		X224677	X224678
2.5 CRD		02.2000	12.2008	ATE	1	66	28/Ø281		X224593	X224594
		02.2000	12.2008	ATE	1	66	28/Ø302		X224677	X224678
2.8 CRD		06.2004	02.2008	ATE	1	66	28/Ø281		X224593	X224594
		01.2008		GIRL-TRW	1	66	28/Ø281		X374695	X374696
3.3		02.2000	05.2007	ATE	1	66	28/Ø281		X224593	X224594
		02.2000	05.2007	ATE	1	66	28/Ø302		X224677	X224678
3.3 AWD		02.2000	05.2007	ATE	1	66	28/Ø281		X224593	X224594
3.8		02.2000	12.2008	ATE	1	66	28/Ø302		X224677	X224678
3.8 AWD		02.2000	12.2008	ATE	1	66	28/Ø281		X224593	X224594
Tout / All / Alle / Tutti / Todos		02.2000	12.2008	ATE	1	42	12,5		X225247	X225248



CITROËN



2 CV

6		02.1970	10.1985	CITROEN	2	42	7	10x100mm	X314019	X314020
		02.1970	07.1990	CITROEN	2	42	7	8x125mm	X314015	X314016

AMI

10 Super (AM3)		03.1973	12.1977	CITROEN	2	45	9		X314023	X314024
8 (AM3)		07.1969	12.1977	CITROEN	2	42	7		X314019	X314020

X=1 : SNRA - X=2 : EAI - X=3 : SERA - X=4 : SEEAC - X=5 : NEOTO - X=6 : STARTCAR

Affectations par Marques

Vehicule application - Zuordnung nach Marke und Fahrzeuge - Applicazione per marca e veicolo - Aplicacion por marca y vehiculo



CITROËN

AX (ZA-)

1.4 GTi		06.1991	12.1997	GIRL-TRW	1	48	20,5		X374005	X374006
Tout / All / Alle / Tutti / Todos		07.1986	10.1990	ATE	1	45	8		X224245	X224246
		07.1986	12.1997	BENDIX	1	48	10		X254087	X254088
		11.1990	12.1997	ATE	1	45	8		X224209	X224210

BERLINGO (B9)

Tout / All / Alle / Tutti / Todos		04.2008		ATE	1	60	26/283 -302		X224765	X224766
		04.2008		GIRL-TRW	1	38	12		X375403	X375404

BERLINGO (M_/MF)

Tout / All / Alle / Tutti / Todos		07.1996	12.2011	BOSCH	1	54	22/Ø266	E5P	X274023	X274024
		07.1996	12.2011	BOSCH	1	54	26/Ø283	E5P	X274039	X274040
		07.1996	12.2011	GIRL-TRW	1	54	13/Ø266		X374403	X374404
		07.1996	12.2011	GIRL-TRW	1	54	20,4/Ø266		X374405	X374406
		07.1996	12.2011	GIRL-TRW	1	38	9		X375295	X375296

BX (XB-)

19 GTi		10.1984	12.1994	BENDIX	1	50	20,4		X254089	X254090
Tout / All / Alle / Tutti / Todos		09.1982	12.1994	BENDIX	1	50	10		X254025	X254026
		09.1982	12.1994	CITROEN	2	30	7		X315003	X315004

C1 I (PM_, PN_)

Tout / All / Alle / Tutti / Todos		06.2005	09.2014	BOSCH	1	48	20		X274087	X274088
-----------------------------------	--	---------	---------	-------	---	----	----	--	---------	---------

C1 II

Tout / All / Alle / Tutti / Todos		04.2014		BOSCH	1	48	20		X274087	X274088
-----------------------------------	--	---------	--	-------	---	----	----	--	---------	---------

C2 (JM_)

1.1		09.2003	12.2009	GIRL-TRW	1	48	13		X374573	X374574
1.4		09.2003	12.2009	GIRL-TRW	1	48	13		X374573	X374574
		09.2003	12.2009	GIRL-TRW	1	54	22		X374575	X374576
1.4 16V		06.2006	12.2009	GIRL-TRW	1	54	22		X374575	X374576
1.4 HDi		09.2003	12.2009	GIRL-TRW	1	48	13		X374573	X374574
		09.2003	12.2009	GIRL-TRW	1	54	22		X374575	X374576
1.6		09.2003		BOSCH	1	54	22/Ø266		X274023	X274024
		09.2003	06.2006	GIRL-TRW	1	54	22		X374575	X374576
1.6 HDi		09.2005		BOSCH	1	54	22/Ø266		X274023	X274024
1.6 VTS		01.2005	12.2009	BOSCH	1	54	22/Ø266		X274023	X274024
Tout / All / Alle / Tutti / Todos		09.2003		GIRL-TRW	1	38	9		X375347	X375348

C2 ENTERPRISE

1.4 HDi		04.2009	12.2009	GIRL-TRW	1	48	13		X374573	X374574
		04.2009	12.2009	GIRL-TRW	1	54	22		X374575	X374576
Tout / All / Alle / Tutti / Todos		04.2009		GIRL-TRW	1	38	9		X375347	X375348

C3 I (FC_)

1.1 i		02.2002	12.2009	GIRL-TRW	1	48	13		X374573	X374574
1.4 16V		12.2003	08.2010	BOSCH	1	54	22/Ø266		X274023	X274024
		12.2003	08.2010	GIRL-TRW	1	54	22		X374575	X374576

X=1 : SNRA - X=2 : EAI - X=3 : SERA - X=4 : SEEC - X=5 : NEOTO - X=6 : STARTCAR

Affectations par Marques

Vehicule application - Zuordnung nach Marke und Fahrzeuge - Applicazione per marca e veicolo - Aplicacion por marca y vehiculo



CITROËN

C3 I (FC_)

1.4 16V HDi		02.2002	06.2008	GIRL-TRW	1	54	22		X374575	X374576
1.4 HDi		02.2002	12.2009	GIRL-TRW	1	48	13		X374573	X374574
1.4 i		02.2002	12.2009	GIRL-TRW	1	48	13		X374573	X374574
1.4 i Bivalent		02.2002	12.2009	GIRL-TRW	1	48	13		X374573	X374574
1.6 16V		02.2002	09.2005	BOSCH	1	54	22/Ø266		X274023	X274024
		02.2002	09.2005	BOSCH	1	54	26/Ø283		X274039	X274040
		02.2002	09.2005	GIRL-TRW	1	54	22		X374575	X374576
1.6 16V HDi		09.2005	12.2009	BOSCH	1	54	26/Ø283		X274039	X274040
		10.2005	12.2009	BOSCH	1	54	22/Ø266		X274023	X274024
		10.2005	12.2009	GIRL-TRW	1	54	22		X374575	X374576
Tout / All / Alle / Tutti / Todos		02.2002	08.2010	GIRL-TRW	1	38	9		X375347	X375348

C3 II

Tout / All / Alle / Tutti / Todos		11.2009		BOSCH	1	54	22/Ø266		X274023	X274024
		11.2009		BOSCH	1	54	26/Ø283		X274095	X274096
		11.2009		GIRL-TRW	1	38	9		X375347	X375348

C3 Picasso

1.4 VTi 95		02.2009		BOSCH	1	54	22/Ø266		X274023	X274024
1.4 VTi 95 LPG		01.2012		BOSCH	1	54	22/Ø266		X274023	X274024
1.6 HDi		02.2009		BOSCH	1	54	22/Ø266		X274023	X274024
		02.2009		BOSCH	1	54	26/Ø283		X274095	X274096
1.6 HDi 110		05.2010		BOSCH	1	54	22/Ø266		X274023	X274024
		05.2010		BOSCH	1	54	26/Ø283		X274095	X274096
1.6 HDi 115		01.2013		BOSCH	1	54	22/Ø266		X274023	X274024
		01.2013		BOSCH	1	54	26/Ø283		X274095	X274096
1.6 HDi 90		07.2010		BOSCH	1	54	22/Ø266		X274023	X274024
1.6 VTi 120		02.2009		BOSCH	1	54	26/Ø283		X274095	X274096
Tout / All / Alle / Tutti / Todos		02.2009		GIRL-TRW	1	38	9		X375347	X375348

C3 Pluriel (HB_)

Tout / All / Alle / Tutti / Todos		05.2003		GIRL-TRW	1	54	22		X374575	X374576
		05.2003		GIRL-TRW	1	38	9		X375347	X375348

C4 AIRCROSS

1.6		12.2010	04.2012	AKE	1	57	26		X164317	X164318
1.6 HDi 115		12.2010	04.2012	AKE	1	57	26		X164317	X164318
1.8 HDi 150		12.2010	04.2012	AKE	1	57	26		X164317	X164318

C4 CACTUS

Tout / All / Alle / Tutti / Todos		09.2014		BOSCH	1	54	22/Ø266		X274023	X274024
-----------------------------------	--	---------	--	-------	---	----	---------	--	---------	---------

C4 Grand Picasso I (UA_)

1.6 16V		07.2008	06.2009	ATE	1	60	26		X224685	X224686
		07.2009	08.2013	ATE	1	60	26/283 -302		X224765	X224766
1.6 HDi		10.2006	01.2009	ATE	1	60	26		X224685	X224686
		02.2009	06.2011	ATE	1	60	26/283 -302		X224765	X224766

X=1 : SNRA - X=2 : EAI - X=3 : SERA - X=4 : SEECAR - X=5 : NEOTO - X=6 : STARTCAR

Affectations par Marques

Vehicule application - Zuordnung nach Marke und Fahrzeuge - Applicazione per marca e veicolo - Aplicacion por marca y vehiculo



CITROËN

C4 Grand Picasso I (UA_)

1.6 HDi 110		09.2010	08.2013	ATE	1	60	26/283 -302		X224765	X224766
1.6 THP 155		09.2010	08.2013	ATE	1	60	26/283 -302		X224765	X224766
1.6 VTi 120		07.2008	01.2009	ATE	1	60	26		X224685	X224686
		02.2009	08.2013	ATE	1	60	26/283 -302		X224765	X224766
1.8 i 16V		10.2006	01.2009	ATE	1	60	26		X224685	X224686
		02.2009	08.2013	ATE	1	60	26/283 -302		X224765	X224766
2.0 HDi 138		10.2006	01.2009	ATE	1	60	26		X224685	X224686
		02.2009	08.2013	ATE	1	60	26/283 -302		X224765	X224766
2.0 HDi 150		07.2009	08.2013	ATE	1	60	26/283 -302		X224765	X224766
2.0 HDi 165		09.2010	08.2013	ATE	1	60	26/283 -302		X224765	X224766
2.0 i 16V		10.2006	06.2009	ATE	1	60	26		X224685	X224686
		07.2009	08.2013	ATE	1	60	26/283 -302		X224765	X224766
Tout / All / Alle / Tutti / Todos		10.2006	08.2013	BOSCH	1	38	12		X275055	X275056

C4 Grand Picasso II

Tout / All / Alle / Tutti / Todos		09.2013		ATE	1	60	28/Ø304		X224889	X224890
		09.2013		BOSCH	1	38	10/Ø268		X277001	X277002
		09.2013		BOSCH	1	42	12/Ø290		X277003	X277004

C4 I (LC_)

1.4 16V		11.2004	07.2011	BOSCH	1	54	22/Ø266		X274023	X274024
		11.2004	07.2011	BOSCH	1	54	26/Ø283		X274039	X274040
1.6 16V		11.2004	07.2011	BOSCH	1	54	26/Ø283		X274039	X274040
1.6 16V Bio-Flex		09.2007	07.2011	BOSCH	1	54	26/Ø283		X274039	X274040
1.6 HDi		11.2004	07.2011	BOSCH	1	54	22/Ø266		X274023	X274024
		11.2004	07.2011	BOSCH	1	54	26/Ø283		X274039	X274040
1.6 THP 140		07.2008	07.2011	BOSCH	1	54	26/Ø283		X274039	X274040
1.6 THP 150		07.2008	07.2011	BOSCH	1	54	26/Ø283		X274039	X274040
1.6 VTi 120		07.2008	07.2011	BOSCH	1	54	22/Ø266		X274023	X274024
		07.2008	07.2011	BOSCH	1	54	26/Ø283		X274039	X274040
2.0 16V		11.2004	07.2011	ATE	1	57	26		X224655	X224656
		11.2004	07.2011	BOSCH	1	54	26/Ø283		X274039	X274040
2.0 HDi		11.2004	07.2008	ATE	1	57	26		X224655	X224656
		04.2007	07.2008	BOSCH	1	54	26/Ø283		X274039	X274040
		08.2008	07.2011	ATE	1	57	26/Ø302		X224759	X224760
Tout / All / Alle / Tutti / Todos		11.2004	07.2011	BOSCH	1	38	9		X275025	X275026
		11.2004	07.2011	GIRL-TRW	1	38	9		X375267	X375268

C4 II (B7)

1.2 THP 130		04.2014		ATE	1	60	26/283 -302		X224765	X224766
		04.2014		GIRL-TRW	1	38	12/Ø268		X375457	X375458
1.4 VTi 95		11.2009		GIRL-TRW	1	57	22/Ø266		X374747	X374748
		11.2009		GIRL-TRW	1	38	12/Ø268		X375457	X375458
		11.2009		GIRL-TRW	1	38	9/Ø247		X375267	X375268

X=1 : SNRA - X=2 : EAI - X=3 : SERA - X=4 : SEEAC - X=5 : NEOTO - X=6 : STARTCAR

Affectations par Marques

Vehicule application - Zuordnung nach Marke und Fahrzeuge - Applicazione per marca e veicolo - Aplicacion por marca y vehiculo



CITROËN

C4 II (B7)

1.6 HDi 100		07.2014		GIRL-TRW	1	57	22/Ø266		X374747	X374748
		07.2014		GIRL-TRW	1	38	9/Ø247		X375267	X375268
1.6 HDi 110		11.2009		ATE	1	60	26/283 -302		X224765	X224766
		11.2009		GIRL-TRW	1	38	9/Ø247		X375267	X375268
1.6 HDi 115		07.2012		ATE	1	60	26/283 -302		X224765	X224766
		07.2012		GIRL-TRW	1	38	12/Ø268		X375457	X375458
		07.2012		GIRL-TRW	1	38	9/Ø247		X375267	X375268
1.6 HDi 90		11.2009		ATE	1	60	26/283 -302		X224765	X224766
		11.2009		GIRL-TRW	1	57	22/Ø266		X374747	X374748
		11.2009		GIRL-TRW	1	38	12/Ø268		X375457	X375458
		11.2009		GIRL-TRW	1	38	9/Ø247		X375267	X375268
1.6 THP 155		11.2009		ATE	1	60	26/283 -302		X224765	X224766
		11.2009		GIRL-TRW	1	38	12/Ø268		X375457	X375458
1.6 VTi 120		11.2009		ATE	1	60	26/283 -302		X224765	X224766
		11.2009		GIRL-TRW	1	38	9/Ø247		X375267	X375268
1.6 VTi 120 LPG		09.2011		ATE	1	60	26/283 -302		X224765	X224766
		09.2011		GIRL-TRW	1	38	12/Ø268		X375457	X375458
		09.2011		GIRL-TRW	1	38	9/Ø247		X375267	X375268
2.0 HDi 150		11.2009		ATE	1	60	26/283 -302		X224765	X224766
		11.2009		GIRL-TRW	1	38	9/Ø247		X375267	X375268

C4 Picasso I (UD_)

1.6 16V		07.2008	06.2009	ATE	1	60	26		X224685	X224686
		07.2009	08.2013	ATE	1	60	26/283 -302		X224765	X224766
1.6 HDi		02.2007	01.2009	ATE	1	60	26		X224685	X224686
		02.2009	08.2013	ATE	1	60	26/283 -302		X224765	X224766
1.6 HDi 110		09.2010	08.2013	ATE	1	60	26/283 -302		X224765	X224766
1.6 THP 140		07.2008	06.2009	ATE	1	60	26		X224685	X224686
		07.2009	08.2013	ATE	1	60	26/283 -302		X224765	X224766
1.6 THP 155		09.2010	08.2013	ATE	1	60	26/283 -302		X224765	X224766
1.6 VTi 120		07.2008	01.2009	ATE	1	60	26		X224685	X224686
		02.2009	08.2013	ATE	1	60	26/283 -302		X224765	X224766
1.8 i 16V		02.2007	01.2009	ATE	1	60	26		X224685	X224686
		02.2009	12.2010	ATE	1	60	26/283 -302		X224765	X224766
2.0 HDi 138		02.2007	06.2009	ATE	1	60	26		X224685	X224686
		07.2009	08.2013	ATE	1	60	26/283 -302		X224765	X224766
2.0 HDi 150		07.2009	08.2013	ATE	1	60	26/283 -302		X224765	X224766
2.0 HDi 165		09.2010	08.2013	ATE	1	60	26/283 -302		X224765	X224766
2.0 i 16V		02.2007	06.2009	ATE	1	60	26		X224685	X224686
		07.2009	08.2013	ATE	1	60	26/283 -302		X224765	X224766
Tout / All / Alle / Tutti / Todos		02.2007	08.2013	BOSCH	1	38	12		X275055	X275056

Affectations par Marques

Vehicule application - Zuordnung nach Marke und Fahrzeuge - Applicazione per marca e veicolo - Aplicacion por marca y vehiculo



CITROËN

C4 Picasso II

Tout / All / Alle / Tutti / Todos		02.2013		ATE	1	60	28/Ø304		X224889	X224890
		02.2013		BOSCH	1	38	10/Ø268		X277001	X277002
		02.2013		BOSCH	1	42	12/Ø290		X277003	X277004

C5 I (DC_)

1.8 16V (DC6FZB, DC6FZE)		03.2001	08.2004	BOSCH	1	54	22/Ø266		X274015	X274016
2.0 16V (DCRFNC, DCRFNF)		03.2001	08.2004	BOSCH	1	57	26/Ø283		X274017	X274018
2.0 16V HPi (DCRLZB)		03.2001	08.2002	BOSCH	1	57	26/Ø283		X274017	X274018
2.0 HDi		03.2001	08.2004	BOSCH	1	57	26/Ø283		X274017	X274018
2.0 HDi (DCRHVB)		03.2001	10.2003	BOSCH	1	57	28/Ø288		X274019	X274020
2.0 HDi (DCRHVB, DCRHZE)		03.2001	08.2004	BOSCH	1	57	26/Ø283		X274017	X274018
2.2 HDi (DC4HXB, DC4HXE)		03.2001	08.2004	BOSCH	1	57	28/Ø288		X274019	X274020
3.0 V6 (DCXFXC, DCXFXF)		03.2001	08.2004	BOSCH	1	57	28/Ø288		X274019	X274020
Tout / All / Alle / Tutti / Todos		03.2001	08.2004	CITROEN	2	32	14		X315023	X315024

C5 I Break (DE_)

1.8 16V (DE6FZB, DE6FZE)		06.2001	08.2004	BOSCH	1	57	26/Ø283		X274017	X274018
2.0 16V (DERFNF, DERFNC, RERFNC)		06.2001	08.2004	BOSCH	1	57	26/Ø283		X274017	X274018
2.0 16V HPi (DERLZB)		06.2001	08.2002	BOSCH	1	57	26/Ø283		X274017	X274018
2.0 HDi		06.2001	08.2004	BOSCH	1	57	26/Ø283		X274017	X274018
2.0 HDi (DERHSB, DERHSE)		06.2001	08.2004	BOSCH	1	57	26/Ø283		X274017	X274018
2.0 HDi (DERHYB)		06.2001	10.2003	BOSCH	1	57	26/Ø283		X274017	X274018
2.2 HDi (DE4HXB, DE4HXE)		06.2001	08.2004	BOSCH	1	57	28/Ø288		X274019	X274020
3.0 Carlsson		09.2003	08.2004	BOSCH	1	57	28/Ø288		X274019	X274020
3.0 V6 (DEXFXC, DEXFXF)		06.2001	08.2004	BOSCH	1	57	28/Ø288		X274019	X274020
Tout / All / Alle / Tutti / Todos		06.2001		CITROEN	2	32	14		X315023	X315024

C5 II (RC_)

1.6 HDi (RC8HZB)		09.2004	01.2008	BOSCH	1	57	26/Ø283		X274017	X274018
1.8 16V		09.2005	01.2008	BOSCH	1	54	22/Ø266		X274015	X274016
1.8 16V (RC6FZB)		09.2004	08.2005	BOSCH	1	54	22/Ø266		X274015	X274016
2.0 16V (RCRFJB, RCRFJC)		09.2004	01.2008	BOSCH	1	57	26/Ø283		X274017	X274018
2.0 HDi (RCRHRH)		09.2004	01.2008	BOSCH	1	57	28/Ø288		X274019	X274020
2.2 HDi		04.2006	01.2008	BOSCH	1	57	28/Ø288		X274019	X274020
		05.2006	01.2008	GIRL-TRW	2	^{40/45}	30		X374599	X374600
2.2 HDi (RC4HXE)		09.2004	08.2005	BOSCH	1	57	28/Ø288		X274019	X274020
3.0 V6		10.2004	04.2007	BOSCH	1	57	28/Ø288		X274019	X274020
3.0 V6 (RCXFUF)		09.2004	01.2008	BOSCH	1	57	28/Ø288		X274019	X274020
Tout / All / Alle / Tutti / Todos		09.2004	01.2008	CITROEN	2	32	14		X315023	X315024

C5 II Break (RE_)

1.6 HDi (RE8HZB)		09.2004	01.2008	BOSCH	1	57	26/Ø283		X274017	X274018
1.8 16V		09.2005	01.2008	BOSCH	1	57	26/Ø283		X274017	X274018
1.8 16V (RE6FZB)		09.2004	08.2005	BOSCH	1	57	26/Ø283		X274017	X274018
2.0 16V (RERFJB, RERFJC)		09.2004	01.2008	BOSCH	1	57	26/Ø283		X274017	X274018

X=1 : SNRA - X=2 : EAI - X=3 : SERA - X=4 : SEEC - X=5 : NEOTO - X=6 : STARTCAR

Affectations par Marques

Vehicule application - Zuordnung nach Marke und Fahrzeuge - Applicazione per marca e veicolo - Aplicacion por marca y vehiculo



CITROËN

C5 II Break (RE_)

2.0 HDi (RERHRH)		09.2004	01.2008	BOSCH	1	57	28/Ø288		X274019	X274020
2.2 HDi		04.2006	01.2008	BOSCH	1	57	28/Ø288		X274019	X274020
2.2 HDi (RE4HXE)		09.2004	09.2006	BOSCH	1	57	28/Ø288		X274019	X274020
3.0		09.2004	01.2008	BOSCH	1	57	28/Ø288		X274019	X274020
3.0 V6 (REXFUF)		09.2004	01.2008	BOSCH	1	57	28/Ø288		X274019	X274020
Tout / All / Alle / Tutti / Todos		09.2004	01.2008	CITROEN	2	32	14		X315023	X315024

C5 III (RD_)

1.6 HDi		02.2008		ATE	1	60	28		X224751	X224752
1.6 HDi 110		07.2010		ATE	1	60	28		X224751	X224752
1.6 HDi 115		01.2012		ATE	1	60	28/Ø304		X224911	X224912
1.6 THP 150		07.2010	06.2012	ATE	1	60	28		X224751	X224752
		07.2012		ATE	1	60	28/Ø304		X224911	X224912
1.6 THP 155		04.2009		ATE	1	60	28		X224751	X224752
1.6 VTi 120		07.2010		ATE	1	60	28		X224751	X224752
1.8 16V		02.2008		ATE	1	60	28		X224751	X224752
2.0 16V		02.2008		ATE	1	60	28		X224751	X224752
2.0 16V BioFlex		02.2008	12.2012	ATE	1	60	28		X224751	X224752
2.0 HDi		02.2008		ATE	1	60	28		X224751	X224752
2.2 HDi		02.2008	12.2011	GIRL-TRW	2	^{40/45}	30		X374599	X374600
2.2 HDi 200		07.2010		ATE	1	60	30/Ø340		X224903	X224904
2.7 HDi		02.2008		GIRL-TRW	2	^{40/45}	30		X374599	X374600
3.0 HDi 240		04.2009		ATE	1	60	30/Ø340		X224903	X224904
3.0 V6		02.2008		GIRL-TRW	2	^{40/45}	30		X374599	X374600
Tout / All / Alle / Tutti / Todos		02.2008		ATE	1	38	12		X225373	X225374
		02.2008		GIRL-TRW	1	38	12		X375333	X375334

C5 III Break (TD_)

1.6 HDi		02.2008		ATE	1	60	28		X224751	X224752
1.6 HDi 110		07.2010		ATE	1	60	28		X224751	X224752
1.6 HDi 115		01.2012		ATE	1	60	28/Ø304		X224911	X224912
1.6 THP 150		04.2009	06.2012	ATE	1	60	28		X224751	X224752
		07.2012		ATE	1	60	28/Ø304		X224911	X224912
1.6 THP 155		04.2009	06.2012	ATE	1	60	28		X224751	X224752
		04.2009		ATE	1	60	28/Ø304		X224911	X224912
1.6 VTi 120		07.2010		ATE	1	60	28		X224751	X224752
1.8 16V		02.2008		ATE	1	60	28		X224751	X224752
2.0 16V		02.2008		ATE	1	60	28		X224751	X224752
2.0 16V BioFlex		02.2008		ATE	1	60	28		X224751	X224752
2.0 HDi		02.2008		ATE	1	60	28		X224751	X224752
2.2 HDi		02.2008	12.2011	GIRL-TRW	2	^{40/45}	30		X374599	X374600
2.2 HDi 200		07.2010		ATE	1	60	30/Ø340		X224903	X224904
2.7 HDi		02.2008		GIRL-TRW	2	^{40/45}	30		X374599	X374600
3.0 HDi 240		04.2009		ATE	1	60	30/Ø340		X224903	X224904

X=1 : SNRA - X=2 : EAI - X=3 : SERA - X=4 : SEEC - X=5 : NEOTO - X=6 : STARTCAR

Affectations par Marques

Vehicule application - Zuordnung nach Marke und Fahrzeuge - Applicazione per marca e veicolo - Aplicacion por marca y vehiculo



CITROËN

C5 III Break (TD_)

3.0 V6		02.2008	12.2010	GIRL-TRW	2	40/45	30		X374599	X374600
Tout / All / Alle / Tutti / Todos		02.2008		ATE	1	38	12		X225373	X225374
		02.2008		GIRL-TRW	1	38	12		X375333	X375334

C6 (TD_)

2.2 HDi		06.2006	12.2012	GIRL-TRW	2	40/45	30		X374599	X374600
2.7 HDi		09.2005	12.2011	GIRL-TRW	2	40/45	30		X374599	X374600
3.0 HDi		04.2009	12.2012	ATE	1	60	30/Ø340		X224903	X224904
3.0 V6		09.2005	12.2012	GIRL-TRW	2	40/45	30		X374599	X374600
Tout / All / Alle / Tutti / Todos		09.2005	12.2012	GIRL-TRW	1	38	22		X375413	X375414

C8 (EA_, EB_)

2.0		07.2002		GIRL-TRW	1	60	28/Ø285		X374589	X374590
2.0 16V		09.2005	12.2011	GIRL-TRW	1	60	28/Ø285		X374589	X374590
2.0 HDi		07.2002	08.2007	GIRL-TRW	1	60	28/Ø285		X374589	X374590
2.0 HDi 135		03.2006		GIRL-TRW	1	60	28/Ø285		X374589	X374590
		03.2006		GIRL-TRW	2	40/45	32		X374699	X374700
2.0 HDi 165		03.2006		GIRL-TRW	2	40/45	32		X374699	X374700
2.2		07.2002	08.2007	GIRL-TRW	1	60	28/Ø285		X374589	X374590
2.2 HDi		07.2002	07.2006	GIRL-TRW	1	60	28/Ø285		X374589	X374590
		06.2006	12.2012	GIRL-TRW	2	40/45	32		X374699	X374700
3.0 V6		07.2002		BREMBO	4	40/44	32		X284113	X284114
Tout / All / Alle / Tutti / Todos		07.2002		GIRL-TRW	1	38	12		X375291	X375292

C15

Tout / All / Alle / Tutti / Todos		10.1984		BENDIX	1	48	10		X254087	X254088
		10.1984	09.2000	CITROEN	2	45	8		X314007	X314008
		10.1984		GIRL-TRW	1	48	10		X374003	X374004

C25

1.8		11.1981	01.1994	GIRL-TRW	2	38/48	13/Ø256		->155247	X374011	X374012
		11.1981	01.1994	GIRL-TRW	2	38/48	16/Ø256		155248->	X374013	X374014
1.8 E		07.1987	02.1994	GIRL-TRW	2	38/48	16/Ø256		155248->	X374013	X374014
1.9 D		07.1987	02.1994	GIRL-TRW	2	38/48	16/Ø256			X374013	X374014
1.9 D 1400		01.1988	01.1994	GIRL-TRW	2	38/48	16/Ø256			X374013	X374014
2.0		11.1981	02.1984	GIRL-TRW	2	38/48	13/Ø256		->155247	X374011	X374012
		11.1981	12.1986	GIRL-TRW	2	38/48	16/Ø256		155248->	X374013	X374014
		01.1987	03.1994	GIRL-TRW	2	43/48	16/Ø290			X374159	X374160
2.0 4x4		01.1990	01.1994	GIRL-TRW	2	38/48	16/Ø256			X374013	X374014
2.0 E		09.1981	02.1984	GIRL-TRW	2	38/48	13/Ø256		->155247	X374011	X374012
		09.1981	02.1994	GIRL-TRW	2	38/48	16/Ø256		155248->	X374013	X374014
2.5 D		11.1981	01.1994	GIRL-TRW	2	43/48	16/Ø290			X374159	X374160
2.5 D Turbo		08.1987	02.1994	GIRL-TRW	2	43/48	16/Ø290			X374159	X374160
2.5 DT		01.1987	01.1994	GIRL-TRW	2	43/48	16/Ø290			X374159	X374160
2.5 DT 4x4		08.1991	01.1994	GIRL-TRW	2	43/48	16/Ø290			X374159	X374160

X=1 : SNRA - X=2 : EAI - X=3 : SERA - X=4 : SEEAC - X=5 : NEOTO - X=6 : STARTCAR

Affectations par Marques

Vehicule application - Zuordnung nach Marke und Fahrzeuge - Applicazione per marca e veicolo - Aplicacion por marca y vehiculo



CITROËN

C32 / C35

Tout / All / Alle / Tutti / Todos		10.1973	01.1994	CITROEN	2	60	20		X314017	X314018
		10.1973	01.1994	CITROEN	2	42	9		X315013	X315014

C-CROSSER (EP_)

Tout / All / Alle / Tutti / Todos		02.2007		AKE	2	43	24		X164207	X164208
		02.2007		AKE	1	38	12		X165167	X165168

C-ELYSEE

Tout / All / Alle / Tutti / Todos		11.2012		BOSCH	1	54	22/Ø266		X274023	X274024
-----------------------------------	--	---------	--	-------	---	----	---------	--	---------	---------

CX I-II

Tout / All / Alle / Tutti / Todos		08.1974		CITROEN	2	30	7		X315003	X315004
-----------------------------------	--	---------	--	---------	---	----	---	--	---------	---------

CX I-II Break

Tout / All / Alle / Tutti / Todos		08.1974		CITROEN	2	40	18		X315001	X315002
-----------------------------------	--	---------	--	---------	---	----	----	--	---------	---------

DS3

Tout / All / Alle / Tutti / Todos		11.2009		BOSCH	1	54	22/Ø266		X274023	X274024
		11.2009		BOSCH	1	54	26/Ø283		X274095	X274096
		11.2009		GIRL-TRW	1	38	9		X375347	X375348

DS4

1.6 BlueHDi 120		07.2014		ATE	1	60	26/283 -302		X224765	X224766
		07.2014		GIRL-TRW	1	38	12/Ø268		X375457	X375458
		07.2014		GIRL-TRW	1	38	9/Ø247		X375267	X375268
1.6 HDi 110		04.2011		ATE	1	60	26/283 -302		X224765	X224766
		04.2011		GIRL-TRW	1	57	22/Ø266		X374747	X374748
		04.2011		GIRL-TRW	1	38	12/Ø268		X375457	X375458
		04.2011		GIRL-TRW	1	38	9/Ø247		X375267	X375268
1.6 HDi 115		08.2012		ATE	1	60	26/283 -302		X224765	X224766
		08.2012		GIRL-TRW	1	38	12/Ø268		X375457	X375458
		08.2012		GIRL-TRW	1	38	9/Ø247		X375267	X375268
1.6 HDi 90		05.2011		ATE	1	60	26/283 -302		X224765	X224766
		05.2011		GIRL-TRW	1	57	22/Ø266		X374747	X374748
		05.2011		GIRL-TRW	1	38	12/Ø268		X375457	X375458
		05.2011		GIRL-TRW	1	38	9/Ø247		X375267	X375268
1.6 THP 155		04.2011		ATE	1	60	26/283 -302		X224765	X224766
		04.2011		GIRL-TRW	1	38	12/Ø268		X375457	X375458
		04.2011		GIRL-TRW	1	38	9/Ø247		X375267	X375268
1.6 THP 160		04.2012		ATE	1	60	26/283 -302		X224765	X224766
		04.2012		GIRL-TRW	1	38	12/Ø268		X375457	X375458
1.6 THP 200		04.2011		ATE	1	60	30/Ø340		X224903	X224904
		04.2011		GIRL-TRW	1	38	12/Ø268		X375457	X375458
1.6 THP 210		07.2015		GIRL-TRW	1	38	12/Ø268		X375457	X375458
		07.2015		GIRL-TRW	1	38	9/Ø247		X375267	X375268

Affectations par Marques

Vehicule application - Zuordnung nach Marke und Fahrzeuge - Applicazione per marca e veicolo - Aplicacion por marca y vehiculo



CITROËN

DS4

1.6 VTi 120		04.2011		ATE	1	60	26/283 -302		X224765	X224766
		04.2011		GIRL-TRW	1	38	12/Ø268		X375457	X375458
		04.2011		GIRL-TRW	1	38	9/Ø247		X375267	X375268
2.0 HDi 135		09.2011		ATE	1	60	26/283 -302		X224765	X224766
		09.2011		ATE	1	60	30/Ø340		X224903	X224904
		09.2011		GIRL-TRW	1	38	12/Ø268		X375457	X375458
2.0 HDi 165		04.2011		ATE	1	60	26/283 -302		X224765	X224766
		04.2011		GIRL-TRW	1	38	12/Ø268		X375457	X375458

DS5

1.6 BlueHDi 120		07.2014	07.2015	GIRL-TRW	1	38	12/Ø268		X375459	X375460
1.6 HDi 110		11.2011	07.2015	GIRL-TRW	1	38	12/Ø268		X375457	X375458
1.6 HDi 115		06.2012	07.2015	GIRL-TRW	1	38	12/Ø268		X375459	X375460
1.6 THP 155		11.2011	07.2015	GIRL-TRW	1	38	12/Ø268		X375457	X375458
1.6 THP 200		11.2011	07.2015	GIRL-TRW	1	38	12/Ø268		X375457	X375458
2.0 HDi 135		11.2011	07.2015	GIRL-TRW	1	38	12/Ø268		X375457	X375458
2.0 HDi 165		11.2011	07.2015	GIRL-TRW	1	38	12/Ø268		X375457	X375458
2.0 HDi 165 Hybrid4 4x4		12.2011	07.2015	GIRL-TRW	1	38	12/Ø268		X375459	X375460
2.0 HDi 180		08.2013	07.2015	GIRL-TRW	1	38	12/Ø268		X375459	X375460
Tout / All / Alle / Tutti / Todos		11.2011	07.2015	ATE	1	60	26/283 -302		X224765	X224766
		11.2011	07.2015	ATE	1	60	30/Ø340		X224903	X224904

DYANE

Tout / All / Alle / Tutti / Todos		07.1968	10.1984	CITROEN	2	42	7	8x125mm	X314015	X314016
		07.1968	10.1984	CITROEN	2	42	7	10x100mm	X314019	X314020

EVASION (22, U6)

1.8		06.1994	07.2002	BENDIX	1	57	20		X254207	X254208
Tout / All / Alle / Tutti / Todos		06.1994	07.2002	GIRL-TRW	1	57	26/Ø281		X374293	X374294
		06.1994	07.2002	ATE	1	36	10		X225161	X225162

GS

1.0		09.1970	09.1977	CITROEN	2	42	9		X314019	X314020
		09.1970	09.1977	CITROEN	2	30	7		X315015	X315016
1.1		09.1977	06.1980	CITROEN	2	42	9		X314019	X314020
		09.1977	06.1980	CITROEN	2	30	7		X315015	X315016
1.2		04.1973	06.1979	CITROEN	2	45	9		X314021	X314022
		04.1973	06.1979	CITROEN	2	30	7		X315005	X315006
A 1.2		04.1973	06.1979	CITROEN	2	45	9		X314021	X314022
		04.1973	06.1979	CITROEN	2	30	7		X315005	X315006
A 1.3		09.1979	07.1986	CITROEN	2	45	9		X314021	X314022
		09.1979	07.1986	CITROEN	2	30	7		X315005	X315006
A Spezial		07.1980	05.1982	CITROEN	2	45	9		X314021	X314022
		07.1980	05.1982	CITROEN	2	30	7		X315005	X315006
X 2		09.1975	07.1979	CITROEN	2	45	9		X314021	X314022
		09.1975	07.1979	CITROEN	2	30	7		X315005	X315006

X=1 : SNRA - X=2 : EAI - X=3 : SERA - X=4 : SEEC - X=5 : NEOTO - X=6 : STARTCAR

Affectations par Marques

Vehicule application - Zuordnung nach Marke und Fahrzeuge - Applicazione per marca e veicolo - Aplicacion por marca y vehiculo



CITROËN

JUMPER I (230/230L/230P)

Tout / All / Alle / Tutti / Todos		02.1994	04.2002	GIRL-TRW	2	40/48	18		ABS	X374223	X374224
		02.1994	04.2002	GIRL-TRW	2	40/48	18		ABS	X374225	X374226
		02.1994	04.2002	GIRL-TRW	2	40/48	24		ABS	X374227	X374228
		02.1994	04.2002	GIRL-TRW	2	40/48	24		ABS	X374229	X374230
		02.1994	04.2002	GIRL-TRW	2	45/48	24		ABS	X374231	X374232
		02.1994	04.2002	GIRL-TRW	2	45/48	24		ABS	X374233	X374234
		02.1994	04.2002	BREMBO	1	46	16			X285031	X285032

JUMPER II (244, Z_)

Tout / All / Alle / Tutti / Todos		02.2002	06.2006	BREMBO	2	44/48	24/Ø280	ABS		->1400	X284045	X284046
		02.2002	06.2006	BREMBO	2	44/48	24/Ø280	ABS		->1400	X284047	X284048
		02.2002	06.2006	BREMBO	2	46/52	24/Ø300	ABS		->1800	X284029	X284030
		02.2002	06.2006	BREMBO	2	46/52	24/Ø300	ABS		->1800	X284049	X284050
		02.2002	06.2006	BREMBO	1	46	16				X285031	X285032

JUMPER III

Tout / All / Alle / Tutti / Todos		04.2006		BREMBO	2	44/48	24/Ø280				X284093	X284094
		04.2006		BREMBO	2	46/52	24/Ø300				X284095	X284096
		04.2006		BREMBO	2	46/52	28/Ø280				X284117	X284118
		04.2006		BREMBO	2	46/52	32/Ø300				X284097	X284098
		04.2006		BOSCH	1	48	16		(+) capteur de plaquette		X275081	X275082
		04.2006		BOSCH	1	48	16		(-) capteur de plaquette		X275051	X275052

JUMPY

1.6 HDi 90		01.2007		GIRL-TRW	2	45/48	28/Ø304				X374663	X374664
		01.2007		GIRL-TRW	2	45/58	28/Ø280				X374661	X374662
1.6 HDi 90 8V		01.2007		GIRL-TRW	2	45/48	28/Ø304				X374663	X374664
2.0 HDi 120		01.2007		GIRL-TRW	2	45/48	28/Ø304				X374663	X374664
2.0 HDi 125		07.2011		GIRL-TRW	2	45/48	28/Ø304				X374663	X374664
2.0 HDi 140		01.2007		GIRL-TRW	2	45/48	28/Ø304				X374663	X374664
2.0 HDi 165		07.2010		GIRL-TRW	2	45/48	28/Ø304				X374663	X374664
2.0 HDi 95		07.2011		GIRL-TRW	2	45/48	28/Ø304				X374663	X374664
2.0 i		01.2007	12.2011	GIRL-TRW	2	45/48	28/Ø304				X374663	X374664
Tout / All / Alle / Tutti / Todos		01.2007		GIRL-TRW	1	41	14				X375341	X375342

JUMPY (BU_, BV_, BW_, BX_)

1.9 TD		10.1999	10.2006	GIRL-TRW	1	57	26/Ø281				X374293	X374294
2.0		12.2003	10.2006	GIRL-TRW	1	60	28/Ø285				X374589	X374590
2.0 HDi 110		12.2003	10.2006	GIRL-TRW	1	60	28/Ø285				X374589	X374590
2.0 HDi 110 16V		12.2003	10.2006	GIRL-TRW	1	60	28/Ø285				X374589	X374590
2.0 HDi 95		10.1999	09.2003	GIRL-TRW	1	57	26/Ø281				X374293	X374294
		10.2003	10.2006	GIRL-TRW	1	60	28/Ø285				X374589	X374590

JUMPY (U6U)

1.6		10.1995	08.2000	GIRL-TRW	1	57	26/Ø281				X374293	X374294
1.9 D		10.1995	04.1998	GIRL-TRW	1	57	26/Ø281				X374293	X374294

X=1 : SNRA - X=2 : EAI - X=3 : SERA - X=4 : SEEAC - X=5 : NEOTO - X=6 : STARTCAR

Affectations par Marques

Vehicule application - Zuordnung nach Marke und Fahrzeuge - Applicazione per marca e veicolo - Aplicacion por marca y vehiculo



CITROËN

JUMPY (U6U)

1.9 D 70		04.1998	11.2003	BENDIX	1	57	20/Ø257		X254207	X254208
		04.1998	11.2003	GIRL-TRW	1	57	26/Ø281		X374293	X374294
1.9 TD		10.1995	08.2000	GIRL-TRW	1	57	26/Ø281		X374293	X374294
		04.1996	10.2006	BENDIX	1	57	20/Ø257		X254207	X254208
2.0		04.2000	12.2001	BENDIX	1	57	20/Ø257		X254207	X254208
		04.2000	12.2006	GIRL-TRW	1	57	26/Ø281		X374293	X374294
		04.2000	12.2006	GIRL-TRW	1	60	28/Ø285		X374589	X374590
2.0 HDi 110		03.2000	09.2003	GIRL-TRW	1	57	26/Ø281		X374293	X374294
		10.2003	10.2006	GIRL-TRW	1	60	28/Ø285		X374589	X374590
2.0 HDi 95		10.1999	09.2003	GIRL-TRW	1	57	26/Ø281		X374293	X374294
		10.1999	10.2006	GIRL-TRW	1	60	28/Ø285		X374589	X374590
2.0 i 16V		03.2000	12.2001	BENDIX	1	57	20/Ø257		X254207	X254208
		03.2000	10.2006	GIRL-TRW	1	57	26/Ø281		X374293	X374294
		03.2000	10.2006	GIRL-TRW	1	60	28/Ø285		X374589	X374590

JUMPY Van(BS_, BT_, BY_, BZ_)

1.6 i		10.1995	08.2000	GIRL-TRW	1	57	26/Ø281		X374293	X374294
1.9 D		10.1995	08.1998	GIRL-TRW	1	57	26/Ø281		X374293	X374294
1.9 D 70		04.1998	10.2006	BENDIX	1	57	20/Ø257		X254207	X254208
		04.1998	10.2006	GIRL-TRW	1	57	26/Ø281		X374293	X374294
1.9 DT		10.1995	08.2000	GIRL-TRW	1	57	26/Ø281		X374293	X374294
1.9 TD		10.1995	08.2000	BENDIX	1	57	20/Ø257		X254207	X254208
		10.1995	08.2000	GIRL-TRW	1	57	26/Ø281		X374293	X374294
2.0 HDi 110		01.2002	09.2003	GIRL-TRW	1	57	26/Ø281		X374293	X374294
		01.2002	10.2006	GIRL-TRW	1	60	28/Ø285		X374589	X374590
2.0 HDi 95		10.1999	10.2006	GIRL-TRW	1	57	26/Ø281		X374293	X374294
		10.1999	10.2006	GIRL-TRW	1	60	28/Ø285		X374589	X374590
2.0 i 16V		03.2000	12.2001	BENDIX	1	57	20/Ø257		X254207	X254208
		03.2000	10.2006	GIRL-TRW	1	57	26/Ø281		X374293	X374294
		03.2000	10.2006	GIRL-TRW	1	60	28/Ø285		X374589	X374590

LNA

0.6		11.1976	07.1979	BENDIX	1	48	10	[Al]	X254187	X254188
		11.1978	07.1986	BENDIX	1	48	10	[Fe]	X254083	X254084
		11.1978	07.1986	CITROEN	2	45	8	[Al]	X314007	X314008
1.1		07.1982	04.1985	BENDIX	1	48	10	[Fe]	X254083	X254084
		07.1982	04.1985	CITROEN	2	45	8	[Al]	X314007	X314008

MEHARI

Tout / All / Alle / Tutti / Todos		07.1977	09.1987	CITROEN	2	42	7	8x125mm	X314015	X314016
		07.1982	04.1985	CITROEN	2	42	7	10x100mm	X314019	X314020
		07.1977	09.1987	CITROEN	2	30	7		X315005	X315006

NEMO

Tout / All / Alle / Tutti / Todos		02.2008		BOSCH	1	54	22/Ø257		X274071	X274072
-----------------------------------	--	---------	--	-------	---	----	---------	--	---------	---------

X=1 : SNRA - X=2 : EAI - X=3 : SERA - X=4 : SEEAC - X=5 : NEOTO - X=6 : STARTCAR

Affectations par Marques

Vehicule application - Zuordnung nach Marke und Fahrzeuge - Applicazione per marca e veicolo - Aplicacion por marca y vehiculo



CITROËN

SAXO (S0, S1)

Tout / All / Alle / Tutti / Todos		02.1996	04.2004	ATE	1	45	8/ #3		X224209	X224210
		02.1996	04.2004	ATE	1	48	20,4/Ø247		X224247	X224248
		02.1996	04.2004	BENDIX	1	48	10/ #4		X254087	X254088
		02.1996	04.2004	BENDIX	1	30	8		X255007	X255008

VISA

0.6		09.1978	05.1986	BENDIX	1	48	10		X254083	X254084
		09.1978	05.1986	CITROEN	2	45	8		X314007	X314008
1.0		09.1984	08.1986	BENDIX	1	48	10		X254083	X254084
		09.1984	08.1986	CITROEN	2	45	8		X314007	X314008
11 E		09.1978	12.1987	BENDIX	1	48	10		X254083	X254084
		09.1978	12.1987	CITROEN	2	45	8		X314007	X314008
14		07.1984	09.1988	CITROEN	2	45	8		X314007	X314008
14 GT		03.1982	03.1991	CITROEN	2	45	8		X314007	X314008
16 GTI		01.1985	08.1988	GIRL-TRW	1	48	20,5		X374005	X374006
17 D		04.1984	10.1989	GIRL-TRW	1	48	10		X374003	X374004
II Super X		07.1980	06.1982	BENDIX	1	48	10		X254083	X254084
		07.1980	06.1982	CITROEN	2	45	8		X314007	X314008

XANTIA (X1)

1.6 i		03.1993	01.1998	BENDIX	1	54	20/Ø266		X254135	X254136
		03.1993	01.1998	CITROEN	2	33	9		X315009	X315010
1.8 i		03.1993	01.1998	BENDIX	1	54	20/Ø266		X254135	X254136
		03.1993	01.1998	CITROEN	2	33	9		X315009	X315010
1.8 i 16V		06.1995	01.1998	BENDIX	1	54	20/Ø266		X254135	X254136
		06.1995	01.1998	CITROEN	2	33	9		X315009	X315010
1.9 D		06.1994	10.1996	BENDIX	1	54	20/Ø266		X254135	X254136
		06.1994	10.1996	CITROEN	2	33	9		X315009	X315010
1.9 SD		02.1996	01.1998	BENDIX	1	54	20/Ø266		X254135	X254136
		02.1996	01.1998	CITROEN	2	33	9		X315009	X315010
1.9 Turbo D		10.1994	01.1998	BENDIX	1	54	20/Ø266		X254135	X254136
		10.1994	01.1998	BOSCH	1	60	28/Ø288		X274021	X274022
		10.1994	01.1998	CITROEN	2	33	9		X315009	X315010
2.0 i		03.1993	01.1998	BENDIX	1	54	20/Ø266		X254135	X254136
		03.1993	01.1998	CITROEN	2	33	9		X315009	X315010
2.0 i 16V		03.1993	01.1998	BENDIX	1	54	20/Ø266		X254135	X254136
		06.1995	01.1998	BENDIX	1	57	26/Ø283		X254095	X254096
		03.1993	01.1998	CITROEN	2	33	9		X315009	X315010
2.0 Turbo		06.1995	01.1998	BENDIX	1	57	26/Ø283		X254095	X254096
		06.1995	01.1998	CITROEN	2	33	9		X315009	X315010
2.1 Turbo D 12V		06.1995	01.1998	BENDIX	1	57	26/Ø283		X254095	X254096
		06.1995	01.1998	CITROEN	2	33	9		X315009	X315010
3.0 i 24V		01.1997	01.1998	BOSCH	1	60	28/Ø288		X274021	X274022
		01.1997	01.1998	CITROEN	2	33	9		X315009	X315010

X=1 : SNRA - X=2 : EAI - X=3 : SERA - X=4 : SEEAC - X=5 : NEOTO - X=6 : STARTCAR

Affectations par Marques

Vehicule application - Zuordnung nach Marke und Fahrzeuge - Applicazione per marca e veicolo - Aplicacion por marca y vehiculo



CITROËN

XANTIA (X2)

1.6 i SX		01.1998	03.2001	BENDIX	1	54	20/Ø266		X254135	X254136
1.8 i		01.1998	12.2001	BENDIX	1	54	20/Ø266		X254135	X254136
1.8 i 16V		01.1998	04.2003	BENDIX	1	54	20/Ø266		X254135	X254136
1.9 SD		01.1998	12.2000	BENDIX	1	54	20/Ø266		X254135	X254136
1.9 Turbo D		01.1998	04.2003	BENDIX	1	54	20/Ø266		X254135	X254136
		01.1998	04.2003	BOSCH	1	60	28/Ø288		X274021	X274022
2.0 HDI 109		02.1999	04.2003	BOSCH	1	60	28/Ø288		X274021	X274022
2.0 HDI 90		03.1999	04.2003	BENDIX	1	54	20/Ø266		X254135	X254136
2.0 i		01.1998	10.1998	BENDIX	1	54	20/Ø266		X254135	X254136
2.0 i 16V		01.1998	04.2003	BENDIX	1	54	20/Ø266		X254135	X254136
		01.1998	10.1998	BENDIX	1	57	26/Ø283		X254095	X254096
		01.1998	04.2003	BOSCH	1	60	28/Ø288		X274021	X274022
2.0 Turbo		01.1998	10.1998	BENDIX	1	57	26/Ø283		X254095	X254096
		01.1998	04.2003	BOSCH	1	60	28/Ø288		X274021	X274022
2.1 Turbo D 12V		01.1998	10.1998	BENDIX	1	57	26/Ø283		X254095	X254096
		01.1998	02.1999	BOSCH	1	60	28/Ø288		X274021	X274022
3.0 V6		01.1998	04.2003	BOSCH	1	60	28/Ø288		X274021	X274022
Tout / All / Alle / Tutti / Todos		01.1998	04.2003	CITROEN	2	33	9		X315009	X315010

XANTIA Break (X1)

Tout / All / Alle / Tutti / Todos		06.1995	01.1998	BENDIX	1	57	22		X254229	X254230
		06.1995	01.1998	BENDIX	1	57	26		X254095	X254096
		06.1995	01.1998	CITROEN	2	36	12		X315017	X315018

XANTIA Break (X2)

Tout / All / Alle / Tutti / Todos		01.1998	04.2003	BENDIX	1	54	20		X254135	X254136
		01.1998	04.2003	BENDIX	1	57	22		X254229	X254230
		01.1998	04.2003	BOSCH	1	60	28		X274021	X274022
		01.1998	04.2003	CITROEN	2	36	12		X315017	X315018

XM (Y3)

Tout / All / Alle / Tutti / Todos		05.1989	07.1994	BENDIX	1	57	22/Ø276		X254091	X254092
		05.1989	07.1994	BENDIX	1	57	26/Ø283		X254095	X254096
		05.1989	07.1994	CITROEN	2	33	9		X315009	X315010
		05.1989	07.1994	CITROEN	2	40	12		X315011	X315012

XM (Y4)

2.0 i 16V		05.1994	10.2000	BENDIX	1	57	26/Ø283		X254095	X254096
2.0 Turbo		05.1994	10.2000	BENDIX	1	57	26/Ø283		X254095	X254096
2.1 D12		07.1994	06.1996	BENDIX	1	57	26/Ø283		X254095	X254096
2.1 D12 VSX		03.1996	10.2000	BENDIX	1	57	26/Ø283		X254095	X254096
2.1 TD 12V		05.1994	10.2000	BENDIX	1	57	26/Ø283		X254095	X254096
2.5 TD		05.1994	10.2000	BENDIX	1	57	26/Ø283		X254095	X254096
		05.1994	10.2000	BOSCH	1	60	28/Ø288		X274021	X274022
3.0 V6		05.1994	10.2000	BENDIX	1	57	26/Ø283		X254095	X254096
		04.1997	10.2000	BOSCH	1	60	28/Ø288		X274021	X274022

X=1 : SNRA - X=2 : EAI - X=3 : SERA - X=4 : SEEC - X=5 : NEOTO - X=6 : STARTCAR

Affectations par Marques

Vehicule application - Zuordnung nach Marke und Fahrzeuge - Applicazione per marca e veicolo - Aplicacion por marca y vehiculo



CITROËN

XM (Y4)

3.0 V6 24V		05.1994	10.2000	BENDIX	1	57	26/Ø283		X254095	X254096
		05.1994	10.2000	BOSCH	1	60	28/Ø288		X274021	X274022
Tout / All / Alle / Tutti / Todos		05.1994	10.2000	CITROEN	2	33	9		X315009	X315010

XM Break (Y3)

Tout / All / Alle / Tutti / Todos		05.1989	07.1994	BENDIX	1	57	22/Ø276		X254091	X254092
		05.1989	07.1994	BENDIX	1	57	26/Ø283		X254095	X254096
		05.1989	07.1994	CITROEN	2	40	12		X315011	X315012

XM Break (Y4)

2.0 i 16V		05.1994	10.2000	BENDIX	1	57	26/Ø283		X254095	X254096
2.0 Turbo		05.1994	10.2000	BENDIX	1	57	26/Ø283		X254095	X254096
2.1 D12		07.1994	06.1996	BENDIX	1	57	26/Ø283		X254095	X254096
2.1 D12 VSX		03.1996	10.2000	BENDIX	1	57	26/Ø283		X254095	X254096
2.1 TD 12V		05.1994	10.2000	BENDIX	1	57	26/Ø283		X254095	X254096
2.5 TD		05.1994	10.2000	BENDIX	1	57	26/Ø283		X254095	X254096
		05.1994	10.2000	BOSCH	1	60	28/Ø288		X274021	X274022
3.0 V6		05.1994	10.2000	BENDIX	1	57	26/Ø283		X254095	X254096
		04.1997	10.2000	BOSCH	1	60	28/Ø288		X274021	X274022
3.0 V6 24V		05.1994	10.2000	BENDIX	1	57	26/Ø283		X254095	X254096
		05.1994	10.2000	BOSCH	1	60	28/Ø288		X274021	X274022
Tout / All / Alle / Tutti / Todos		05.1994	10.2000	CITROEN	2	40	12		X315011	X315012

XSARA (N1)

1.4 HDi		01.2003	03.2005	BOSCH	1	54	22/Ø266		X274023	X274024
1.4 i		04.1997	03.2005	ATE	1	48	20,4/Ø247		X224247	X224248
		04.1997	03.2005	BOSCH	1	48	13/Ø247		X274007	X274008
		04.1997	03.2005	BOSCH	1	54	22/Ø266		X274023	X274024
1.4 LPG		05.1998	08.2000	ATE	1	48	20,4/Ø247		X224247	X224248
		05.1998	08.2000	BOSCH	1	48	13/Ø247		X274007	X274008
1.5 D		04.1997	09.2000	ATE	1	48	20,4/Ø247		X224247	X224248
		04.1997	09.2000	BOSCH	1	48	13/Ø247		X274007	X274008
1.6 16V		09.2000	03.2005	BOSCH	1	54	22/Ø266		X274023	X274024
1.6 i		04.1997	09.2000	ATE	1	48	20,4/Ø247		X224247	X224248
1.8 D		04.1997	09.2000	ATE	1	48	20,4/Ø247		X224247	X224248
1.8 i		04.1997	09.2000	ATE	1	48	20,4/Ø247		X224247	X224248
1.8 i 16V		04.1997	09.2000	BOSCH	1	54	20,4/Ø266		X274011	X274012
		04.1997	09.2000	GIRL-TRW	1	54	20,4/Ø266		X374405	X374406
1.8 i Aut.		04.1997	09.2000	ATE	1	48	20,4/Ø247		X224247	X224248
		04.1997	09.2000	BOSCH	1	54	20,4/Ø266		X274011	X274012
		04.1997	09.2000	GIRL-TRW	1	54	20,4/Ø266		X374405	X374406
1.9 D		04.1997	03.2005	ATE	1	48	20,4/Ø247		X224247	X224248
		07.1998	03.2005	BOSCH	1	54	22/Ø266		X274023	X274024
1.9 SD		01.1998	09.2000	ATE	1	48	20,4/Ø247		X224247	X224248
1.9 TD		04.1997	09.2000	ATE	1	48	20,4/Ø247		X224247	X224248

X=1 : SNRA - X=2 : EAI - X=3 : SERA - X=4 : SEEAC - X=5 : NEOTO - X=6 : STARTCAR

Affectations par Marques

Vehicule application - Zuordnung nach Marke und Fahrzeuge - Applicazione per marca e veicolo - Aplicacion por marca y vehiculo



CITROËN

XSARA (N1)

2.0 16V		07.1998	09.2000	BOSCH	1	54	20,4/Ø266		X274011	X274012
		09.2000	01.2002	GIRL-TRW	1	57	22		X374411	X374412
		02.2002	03.2005	BOSCH	1	54	26/Ø283		X274039	X274040
2.0 HDi 109		05.2001	01.2002	GIRL-TRW	1	57	22		X374411	X374412
		02.2002	03.2005	BOSCH	1	54	26/Ø283		X274039	X274040
2.0 HDi 90		02.1999	03.2005	BOSCH	1	54	22/Ø266		X274023	X274024
		02.1999	03.2005	GIRL-TRW	1	54	20,4/Ø266		X374405	X374406
Tout / All / Alle / Tutti / Todos		04.1997	03.2005	BENDIX	1	32	8		X255033	X255034

XSARA Break (N2)

1.4 HDi		01.2003	08.2005	BOSCH	1	54	22/Ø266		X274023	X274024
1.4 i		10.1997	08.2005	ATE	1	48	20,4/Ø247		X224247	X224248
		10.1997	08.2000	BOSCH	1	54	20,4/Ø266		X274011	X274012
		10.1997	08.2005	BOSCH	1	54	22/Ø266		X274023	X274024
		10.1997	08.2000	GIRL-TRW	1	54	20,4/Ø266		X374405	X374406
1.5 D		10.1997	09.2000	ATE	1	48	20,4/Ø247		X224247	X224248
		10.1997	09.2000	BOSCH	1	48	13/Ø247		X274007	X274008
1.6 16V		09.2000	08.2005	BOSCH	1	54	22/Ø266		X274023	X274024
1.6 i		10.1997	09.2000	ATE	1	48	20,4/Ø247		X224247	X224248
		10.1997	09.2000	BOSCH	1	54	20,4/Ø266		X274011	X274012
		10.1997	09.2000	GIRL-TRW	1	54	20,4/Ø266		X374405	X374406
1.8 D		10.1997	09.2000	ATE	1	48	20,4/Ø247		X224247	X224248
		10.1997	09.2000	BOSCH	1	54	20,4/Ø266		X274011	X274012
		10.1997	09.2000	GIRL-TRW	1	54	20,4/Ø266		X374405	X374406
1.8 i		10.1997	09.2000	BOSCH	1	54	20,4/Ø266		X274011	X274012
		10.1997	09.2000	GIRL-TRW	1	54	20,4/Ø266		X374405	X374406
1.8 i 16V		10.1997	09.2000	BOSCH	1	54	20,4/Ø266		X274011	X274012
		10.1997	09.2000	GIRL-TRW	1	54	20,4/Ø266		X374405	X374406
1.8 i Aut.		10.1997	09.2000	BOSCH	1	54	20,4/Ø266		X274011	X274012
		10.1997	09.2000	GIRL-TRW	1	54	20,4/Ø266		X374405	X374406
1.8 LPG		05.1998	08.2000	BOSCH	1	54	20,4/Ø266		X274011	X274012
		05.1998	08.2000	GIRL-TRW	1	54	20,4/Ø266		X374405	X374406
1.9 D		10.1997	08.2005	ATE	1	48	20,4/Ø247		X224247	X224248
		10.1997	08.2000	BOSCH	1	54	20,4/Ø266		X274011	X274012
		10.1997	08.2000	GIRL-TRW	1	54	20,4/Ø266		X374405	X374406
		07.1998	08.2005	BOSCH	1	54	22/Ø266		X274023	X274024
1.9 TD		10.1997	09.2000	BOSCH	1	54	20,4/Ø266		X274011	X274012
		10.1997	09.2000	GIRL-TRW	1	54	20,4/Ø266		X374405	X374406
2.0 16V		07.1998	09.2000	BOSCH	1	54	20,4/Ø266		X274011	X274012
		07.1998	09.2000	GIRL-TRW	1	54	20,4/Ø266		X374405	X374406
		09.2000	01.2002	GIRL-TRW	1	57	22		X374411	X374412
		02.2002	08.2005	BOSCH	1	54	26/Ø283		X274039	X274040
2.0 HDi 109		05.2001	01.2002	GIRL-TRW	1	57	22		X374411	X374412
		02.2002	08.2005	BOSCH	1	54	26/Ø283		X274039	X274040

X=1 : SNRA - X=2 : EAI - X=3 : SERA - X=4 : SEEAC - X=5 : NEOTO - X=6 : STARTCAR

Affectations par Marques

Vehicule application - Zuordnung nach Marke und Fahrzeuge - Applicazione per marca e veicolo - Aplicacion por marca y vehiculo



CITROËN

XSARA Break (N2)

2.0 HDI 90		02.1999	08.2005	BOSCH	1	54	22/Ø266		X274023	X274024
Tout / All / Alle / Tutti / Todos		10.1997		BENDIX	1	32	8		X255033	X255034

XSARA Coupé (N0)

1.4 HDi		01.2003	03.2005	BOSCH	1	54	22/Ø266		X274023	X274024
1.4 i		03.1998	03.2005	ATE	1	48	20,4/Ø247		X224247	X224248
		03.1998	08.2000	BOSCH	1	48	13/Ø247		X274007	X274008
		03.1998	03.2005	BOSCH	1	54	22/Ø266		X274023	X274024
1.6 16V		09.2000	10.2004	BOSCH	1	54	22/Ø266		X274023	X274024
1.6 i		02.1998	09.2000	ATE	1	48	20,4/Ø247		X224247	X224248
1.8 i		02.1998	09.2000	ATE	1	48	20,4/Ø247		X224247	X224248
		02.1998	09.2000	BOSCH	1	54	20,4/Ø266		X274011	X274012
		02.1998	09.2000	GIRL-TRW	1	54	20,4/Ø266		X374405	X374406
1.8 i 16V		02.1998	09.2000	BOSCH	1	54	20,4/Ø266		X274011	X274012
		02.1998	09.2000	GIRL-TRW	1	54	20,4/Ø266		X374405	X374406
1.9 D		02.1998	03.2005	ATE	1	48	20,4/Ø247		X224247	X224248
		02.1999	03.2005	BOSCH	1	54	22/Ø266		X274023	X274024
1.9 TD		02.1998	09.2000	ATE	1	48	20,4/Ø247		X224247	X224248
2.0 16V		09.2000	01.2002	GIRL-TRW	1	57	22		X374411	X374412
		02.2002	03.2005	BOSCH	1	54	26/Ø283		X274039	X274040
2.0 HDi 109		05.2001	01.2002	GIRL-TRW	1	57	22		X374411	X374412
		02.2002	03.2005	BOSCH	1	54	26/Ø283		X274039	X274040
2.0 HDI 90		02.1999	03.2005	BOSCH	1	54	22/Ø266		X274023	X274024
		02.1999	03.2005	GIRL-TRW	1	54	20,4/Ø266		X374405	X374406
2.0 i 16V		02.1998	01.2002	GIRL-TRW	1	57	22		X374411	X374412
		02.2002	03.2005	BOSCH	1	54	26/Ø283		X274039	X274040
Tout / All / Alle / Tutti / Todos		02.1998	03.2005	BENDIX	1	32	8		X255033	X255034

XSARA PICASSO (N68)

Tout / All / Alle / Tutti / Todos		12.1999	12.2011	BOSCH	1	54	22/Ø266		X274023	X274024
		12.1999	12.2011	BOSCH	1	54	26/Ø283		X274039	X274040
		12.1999	12.2011	GIRL-TRW	1	54	20,4/Ø266		X374405	X374406
		12.1999	12.2011	GIRL-TRW	1	38	9		X375295	X375296

ZX (N2)

1.1		03.1991	06.1997	BENDIX	1	48	10		X254087	X254088
1.4		03.1991	06.1997	BENDIX	1	48	10		X254087	X254088
1.4 D		07.1994	10.1997	BENDIX	1	48	10		X254087	X254088
1.4 i		03.1991	10.1997	BENDIX	1	48	10		X254087	X254088
1.6		03.1991	10.1997	GIRL-TRW	1	48	20		X374007	X374008
1.8 D		06.1993	10.1997	BENDIX	1	48	10		X254087	X254088
		06.1993	10.1997	GIRL-TRW	1	48	20		X374007	X374008
1.9 D		03.1991	06.1997	GIRL-TRW	1	48	10		X374003	X374004
		03.1991	10.1997	GIRL-TRW	1	48	20		X374007	X374008

Affectations par Marques

Vehicule application - Zuordnung nach Marke und Fahrzeuge - Applicazione per marca e veicolo - Aplicacion por marca y vehiculo



CITROËN

ZX (N2)

1.9 DT		06.1992	10.1997	BENDIX	1	48	10		X254087	X254088
		06.1992	10.1997	GIRL-TRW	1	48	10		X374003	X374004
		06.1992	10.1997	GIRL-TRW	1	48	20		X374007	X374008
1.9 TD		07.1992	06.1994	BENDIX	1	48	10		X254087	X254088
		07.1992	06.1994	GIRL-TRW	1	48	10		X374003	X374004
		07.1992	10.1997	GIRL-TRW	1	48	20		X374007	X374008
2.0		09.1996	10.1997	GIRL-TRW	1	48	20		X374007	X374008
		09.1996	10.1997	GIRL-TRW	1	57	22		X374411	X374412
2.0 i 16V		07.1992	10.1997	GIRL-TRW	1	48	20		X374007	X374008
		07.1992	06.1997	GIRL-TRW	1	54	20,4		X374257	X374258
		05.1996	06.1997	GIRL-TRW	1	57	22		X374411	X374412
		07.1992	06.1997	BENDIX	1	32	8		X255033	X255034
Tout / All / Alle / Tutti / Todos		03.1991	10.1997	BENDIX	1	30	8		X255007	X255008

ZX Break (N2)

1.4 i		10.1993	10.1997	BENDIX	1	48	10		X254087	X254088
1.5 D		06.1996	02.1998	BENDIX	1	48	10		X254087	X254088
1.6 i		10.1993	10.1997	GIRL-TRW	1	48	20		X374007	X374008
1.8 D		10.1993	10.1997	BENDIX	1	48	10		X254087	X254088
		10.1993	10.1997	GIRL-TRW	1	48	10		X374003	X374004
1.8 i		10.1993	10.1997	GIRL-TRW	1	48	20		X374007	X374008
1.8 i 16v		01.1996	02.1998	GIRL-TRW	1	48	20		X374007	X374008
1.9 D		10.1993	07.1999	BENDIX	1	48	10		X254087	X254088
		10.1993	07.1999	GIRL-TRW	1	48	10		X374003	X374004
		10.1993	07.1999	GIRL-TRW	1	48	20		X374007	X374008
1.9 TD		10.1993	10.1997	BENDIX	1	48	10		X254087	X254088
		10.1993	10.1997	GIRL-TRW	1	48	10		X374003	X374004
		10.1993	10.1997	GIRL-TRW	1	48	20		X374007	X374008
2.0		10.1993	11.1995	BENDIX	1	48	10		X254087	X254088
		10.1993	11.1995	GIRL-TRW	1	48	10		X374003	X374004
		10.1993	11.1995	GIRL-TRW	1	48	20		X374007	X374008
2.0 i 16V		07.1992	06.1997	BENDIX	1	48	10		X254087	X254088
		07.1992	06.1997	GIRL-TRW	1	48	10		X374003	X374004
		07.1992	06.1997	GIRL-TRW	1	48	20		X374007	X374008
		07.1992	06.1997	BENDIX	1	32	8		X255033	X255034
Tout / All / Alle / Tutti / Todos		03.1991	10.1997	BENDIX	1	30	8		X255007	X255008

DACIA

1210-1310

Tout / All / Alle / Tutti / Todos		07.1982	12.1994	BENDIX	1	48	10		X254031	X254032
-----------------------------------	--	---------	---------	--------	---	----	----	--	---------	---------

DOKKER

Tout / All / Alle / Tutti / Todos		11.2012		ATE	1	54	24		X224817	X224818
		11.2012		GIRL-TRW	1	54	22		X374631	X374632

X=1 : SNRA - X=2 : EAI - X=3 : SERA - X=4 : SEEAC - X=5 : NEOTO - X=6 : STARTCAR

Affectations par Marques

Vehicule application - Zuordnung nach Marke und Fahrzeuge - Applicazione per marca e veicolo - Aplicacion por marca y vehiculo



DUSTER

1.2 TCe 125		10.2013		ATE	1	54	24		X224817	X224818
1.5 dCi		04.2010		ATE	1	54	24		X224817	X224818
		04.2010		GIRL-TRW	1	54	22		X374631	X374632
1.5 dCi 4x4		06.2010	07.2013	ATE	1	54	24		X224817	X224818
1.6 16V		04.2010		GIRL-TRW	1	54	22		X374631	X374632
1.6 16V 4x4		06.2010		GIRL-TRW	1	54	22		X374631	X374632
1.6 16V Hi-Flex		08.2010		GIRL-TRW	1	54	22		X374631	X374632
1.6 16V LPG		04.2011		GIRL-TRW	1	54	22		X374631	X374632

LODGY

1.2 TCe		03.2012		ATE	1	54	24		X224817	X224818
1.5 dCi		06.2010		ATE	1	54	24		X224817	X224818
		03.2012		GIRL-TRW	1	54	22		X374631	X374632
1.6		03.2012		ATE	1	54	24		X224817	X224818
		03.2012		GIRL-TRW	1	54	22		X374631	X374632
1.6 LPG		11.2013		ATE	1	54	24		X224817	X224818
		11.2013		GIRL-TRW	1	54	22		X374631	X374632

LOGAN I (LS_)

Tout / All / Alle / Tutti / Todos		09.2004		GIRL-TRW	1	48	12		X374029	X374030
		09.2004		GIRL-TRW	1	48	20,5		X374007	X374008

LOGAN I (US_)

Tout / All / Alle / Tutti / Todos		03.2008		ATE	1	54	22		X224847	X224848
		03.2008		GIRL-TRW	1	54	22		X374631	X374632

LOGAN I EXPRESS (FS_)

Tout / All / Alle / Tutti / Todos		03.2009		GIRL-TRW	1	54	22/Ø260		X374631	X374632
-----------------------------------	--	---------	--	----------	---	----	---------	--	---------	---------

LOGAN I MCV (KS_)

1.4		02.2007	12.2012	ATE	1	54	22		X224847	X224848
		02.2007	12.2012	GIRL-TRW	1	48	20,5		X374007	X374008
1.5 dCi (KS04)		05.2010	06.2013	GIRL-TRW	1	48	20,5		X374007	X374008
1.5 dCi (KS0K)		02.2007	11.2008	ATE	1	54	22		X224847	X224848
		02.2007	06.2013	GIRL-TRW	1	48	20,5		X374007	X374008
		02.2007		GIRL-TRW	1	54	22		X374631	X374632
1.5 dCi (KS0W)		09.2007	12.2012	ATE	1	54	22		X224847	X224848
1.6		02.2007	06.2013	ATE	1	54	22		X224847	X224848
		02.2007	06.2013	GIRL-TRW	1	48	20,5		X374007	X374008
1.6 16V		02.2007	11.2008	ATE	1	54	22		X224847	X224848
		02.2007		GIRL-TRW	1	54	22		X374631	X374632
1.6 16V Hi-Flex		11.2009	06.2013	ATE	1	54	22		X224847	X224848
		11.2009	06.2013	GIRL-TRW	1	54	22		X374631	X374632
1.6 Bifuel		11.2008	06.2013	ATE	1	54	22		X224847	X224848
1.6 MPI 85		05.2010	06.2013	GIRL-TRW	1	48	20,5		X374007	X374008

Affectations par Marques

Vehicule application - Zuordnung nach Marke und Fahrzeuge - Applicazione per marca e veicolo - Aplicacion por marca y vehiculo



LOGAN II											
Tout / All / Alle / Tutti / Todos		10.2012		ATE	1	48	22			X224877	X224878

LOGAN II MCV											
Tout / All / Alle / Tutti / Todos		02.2013		ATE	1	48	22			X224877	X224878

SANDERO I											
Tout / All / Alle / Tutti / Todos		06.2008	12.2012	GIRL-TRW	1	48	12			X374029	X374030
		06.2008	12.2012	GIRL-TRW	1	48	20,5			X374007	X374008

SANDERO II											
Tout / All / Alle / Tutti / Todos		10.2012		ATE	1	48	22			X224877	X224878



ARANOS											
Tout / All / Alle / Tutti / Todos		01.1995	12.1997	ATE	1	52	24			X224045	X224046

CIELO											
Tout / All / Alle / Tutti / Todos		06.1994	06.2008	ATE	1	52	24			X224045	X224046

ESPERO (KLEJ)											
Tout / All / Alle / Tutti / Todos		02.1995	12.1999	ATE	1	52	24			X224045	X224046

EVANDA (KLAL)											
Tout / All / Alle / Tutti / Todos		08.2002	04.2004	DAC	1	57	24			X324011	X324012
		08.2002	04.2004	DAC	1	35	12			X325007	X325008

KALOS (KLAS)											
Tout / All / Alle / Tutti / Todos		09.2002	12.2004	DAC	1	52	20			X324009	X324010

KORANDO (KJ)											
Tout / All / Alle / Tutti / Todos		01.1999	12.2004	MANDO	1	60			Fe	X484083	X484084
		01.1999	12.2004	PBR	1	60			Al	X594001	X594002
		01.1999	12.2004	MANDO	1	38			Fe	X485049	X485050
		01.1999	12.2004	PBR	1	40			Al	X595001	X595002

LACETTI											
Tout / All / Alle / Tutti / Todos		06.1999		DAC	1	54	24			X324001	X324002
		06.1999		DAC	1	32	10			X325005	X325006

LANOS (KLAT)											
1.4		05.1997	12.2002	ATE	1	48	20			X224195	X224196
		05.1997	12.2002	DAC	1	48	20			X324005	X324006
		05.1997	12.2002	DAC	1	52	24			X324007	X324008
1.5		05.1997	12.2002	DAC	1	52	20			X324005	X324006

LEGANZA (KLAV)											
Tout / All / Alle / Tutti / Todos		06.1997		DAC	1	57	24			X324011	X324012
		06.1997		DAC	1	35	10			X325009	X325010

Affectations par Marques

Vehicule application - Zuordnung nach Marke und Fahrzeuge - Applicazione per marca e veicolo - Aplicacion por marca y vehiculo



DAEWOO



MAGNUS

Tout / All / Alle / Tutti / Todos		07.1999		DAC	1	57	24		X324011	X324012
		07.1999		DAC	1	35	12		X325007	X325008

MATIZ (KLYA)

0.8		09.1998	12.2004	DAC	1	48	12,6		X324003	X324004
		09.1998	12.2004	DAC	1	48	12,6		X324013	X324014
		09.1998	12.2004	DAC	1	48	12,6		X324015	X324016
1.0		01.2003	12.2004	DAC	1	48	12,6		X324003	X324004
		01.2003	12.2004	DAC	1	48	12,6		X324013	X324014

MUSSO (FJ)

2.2 TD		01.1999		MANDO	1	38	10,5		X485049	X485050
		01.1999		PBR	1	40			X595001	X595002
Tout / All / Alle / Tutti / Todos		09.1999		MANDO	1	60			X484083	X484084
		09.1999		PBR	1	60			X594001	X594002

NEXIA (KLETN)

1.5		02.1995	08.1997	ATE	1	48	20		X224195	X224196
1.5 16V		02.1995	08.1997	ATE	1	52	24		X224045	X224046
1.6		08.1997	06.2008	ATE	1	52	24		X224045	X224046
1.8		02.1995	06.2008	ATE	1	52	24		X224045	X224046

NUBIRA (KLAJ)

1.6		08.2002	07.2003	DAC	1	54	24		X324001	X324002
1.6 16V		06.1998	08.2000	ATE	1	52	24		X224045	X224046
		09.2000	07.2003	DAC	1	54	24		X324001	X324002
2.0		06.1999	07.2003	DAC	1	54	24		X324001	X324002
2.0 16V		05.1997	12.1999	DAC	1	54	24		X324001	X324002
2.0 CDX		08.2002	07.2003	DAC	1	54	24		X324001	X324002
Tout / All / Alle / Tutti / Todos		02.1997	03.2005	DAC	1	32	10		X325001	X325002
		02.1997	03.2005	DAC	1	32	10		X325003	X325004
		02.1997	03.2005	DAC	1	32	10		X325005	X325006

NUBIRA (KLAN)

Tout / All / Alle / Tutti / Todos		07.2003		DAC	1	54	24		X324001	X324002
		07.2003		DAC	1	32	10		X325005	X325006

PRINCE (J19)

Tout / All / Alle / Tutti / Todos		08.1993	08.1999	ATE	1	52	24		X224045	X224046
-----------------------------------	--	---------	---------	-----	---	----	----	--	---------	---------

REXTON (GAB_)

Tout / All / Alle / Tutti / Todos		04.2002		MANDO	2	43			X484069	X484070
		04.2002		MANDO	1	43			X485017	X485018

REZZO (KLAU)

Tout / All / Alle / Tutti / Todos		09.2000		DAC	1	57	24		X324011	X324012
-----------------------------------	--	---------	--	-----	---	----	----	--	---------	---------

TACUMA

Tout / All / Alle / Tutti / Todos		09.2000		DAC	1	57	24		X324011	X324012
-----------------------------------	--	---------	--	-----	---	----	----	--	---------	---------

X=1 : SNRA - X=2 : EAI - X=3 : SERA - X=4 : SEEAC - X=5 : NEOTO - X=6 : STARTCAR

Affectations par Marques

Vehicule application - Zuordnung nach Marke und Fahrzeuge - Applicazione per marca e veicolo - Aplicacion por marca y vehiculo



DAEWOO



TOSCA

Tout / All / Alle / Tutti / Todos		02.2006		DAC	1	35	12		X325007	X325008
-----------------------------------	--	---------	--	-----	---	----	----	--	---------	---------



DAF



400-Serie

Tout / All / Alle / Tutti / Todos		04.1989	01.1997	LOCK	4	46	24		X464095	X464096
-----------------------------------	--	---------	---------	------	---	----	----	--	---------	---------



DAIHATSU



APPLAUSE I (A101, A111)

Tout / All / Alle / Tutti / Todos		06.1989	07.1997	AKE	1	51	18		X164195	X164196
		06.1989	07.1997	NAB	1	30	10		X525013	X525014

APPLAUSE II (A101)

Tout / All / Alle / Tutti / Todos		07.1997	05.2000	AKE	1	51	18		X164195	X164196
-----------------------------------	--	---------	---------	-----	---	----	----	--	---------	---------

CHARADE I (G10)

Tout / All / Alle / Tutti / Todos		10.1977	05.1984	ASCO	2	48	10		X194001	X194002
-----------------------------------	--	---------	---------	------	---	----	----	--	---------	---------

CHARADE II (G11, G30)

Tout / All / Alle / Tutti / Todos		10.1983	03.1987	AKE	1	48	11		X164001	X164002
-----------------------------------	--	---------	---------	-----	---	----	----	--	---------	---------

CHARADE III (G100, G101, G102)

Tout / All / Alle / Tutti / Todos		03.1987	01.1993	AKE	1	51	11		X164075	X164076
		03.1987	01.1993	AKE	1	51	18		X164195	X164196
		03.1987	01.1993	NAB	1	30	10		X525001	X525002

CHARADE IV (G200, G202, G203)

Tout / All / Alle / Tutti / Todos		01.1993	01.2001	AKE	1	51	18		X164243	X164244
		01.1993	01.2001	AKE	1	30	9		X165131	X165132

COPEN

Tout / All / Alle / Tutti / Todos		09.2003	09.2012	TOKICO	1	51	16		X674099	X674100
-----------------------------------	--	---------	---------	--------	---	----	----	--	---------	---------

CUORE II (L80, L81)

Tout / All / Alle / Tutti / Todos		09.1985	12.1990	SUMITOMO	1	51	19		X644039	X644040
-----------------------------------	--	---------	---------	----------	---	----	----	--	---------	---------

CUORE III (L201)

Tout / All / Alle / Tutti / Todos		08.1990	12.1994	AKE	1	51	16		X164267	X164268
		08.1990	12.1994	AKE	1	51	19		X164073	X164074

CUORE Mk VI (L7_)

Tout / All / Alle / Tutti / Todos		10.1998	05.2003	SUMITOMO	1	51			X644171	X644172
-----------------------------------	--	---------	---------	----------	---	----	--	--	---------	---------

CUORE VI (L251, L250_, L260_)

Tout / All / Alle / Tutti / Todos		05.2003		AKE	1	51	11		X164293	X164294
-----------------------------------	--	---------	--	-----	---	----	----	--	---------	---------

CUORE VII (L275_, L276_, L285_)

Tout / All / Alle / Tutti / Todos		04.2007		TOKICO	1	51	16,5		X674099	X674100
-----------------------------------	--	---------	--	--------	---	----	------	--	---------	---------

FEROZA (F300)

Tout / All / Alle / Tutti / Todos		10.1988	12.1999	AKE	1	54	12,5		X164135	X164136
		10.1988	12.1999	AKE	1	54	18		X164255	X164256

X=1 : SNRA - X=2 : EAI - X=3 : SERA - X=4 : SEEC - X=5 : NEOTO - X=6 : STARTCAR

Affectations par Marques

Vehicule application - Zuordnung nach Marke und Fahrzeuge - Applicazione per marca e veicolo - Aplicacion por marca y vehiculo



DAIHATSU



GRAN MOVE (G3)

Tout / All / Alle / Tutti / Todos		10.1996	07.2002	AKE	1	51	18		X164243	X164244
		10.1996	07.2002	AKE	1	30	9		X165131	X165132

HIJET

0.8		06.1986	10.1990	SUMITOMO	1	51			X644131	X644132
1.0		06.1986	10.1990	SUMITOMO	1	51			X644131	X644132
1.0 4x4		07.1986	10.1990	SUMITOMO	1	51			X644133	X644134

MOVE (L6, L9)

Tout / All / Alle / Tutti / Todos		10.1998		AKE	1	51	16		X164289	X164290
		10.1998		TOKICO	1	51	16		X674099	X674100

ROCKY (F7, F8)

2.0		02.1985	04.1993	AKE	1	54	13		X164077	X164078
		02.1985	04.1993	AKE	1	54	18		X164079	X164080
2.2 4x4		09.1991	04.1993	AKE	1	54	13		X164077	X164078
		09.1991	04.1993	AKE	1	54	18		X164079	X164080
2.8 D		02.1985	12.1998	AKE	1	54	13		X164077	X164078
		02.1985	12.1998	AKE	1	54	18		X164079	X164080
2.8 TD		12.1987	04.1993	AKE	1	54	13		X164077	X164078
		12.1987	04.1993	AKE	1	54	18		X164079	X164080
		09.1991	12.1998	AKE	1	54	18		X164255	X164256

RUGGER

2.0 4x4		04.1984	10.1988	AKE	1	54	13		X164077	X164078
2.8 D 4x4		05.1993	09.1994	AKE	1	54	18		X164255	X164256
2.8 TDiC 4x4		04.1984	04.1993	AKE	1	54	13		X164077	X164078
		07.1996	12.1999	AKE	1	54	18		X164255	X164256

SIRION (M1)

Tout / All / Alle / Tutti / Todos		04.1998	01.2005	AKE	1	51	16		X164289	X164290
-----------------------------------	--	---------	---------	-----	---	----	----	--	---------	---------

SIRION (M3_)

Tout / All / Alle / Tutti / Todos		01.2005		TOKICO	1	51	16		X674099	X674100
-----------------------------------	--	---------	--	--------	---	----	----	--	---------	---------

TERIOS (J1/J2)

Tout / All / Alle / Tutti / Todos		05.1997		SUMITOMO	1	54	16/Ø273		X644161	X644162
-----------------------------------	--	---------	--	----------	---	----	---------	--	---------	---------

WILDCAT/ROCKY (F70)

Tout / All / Alle / Tutti / Todos		02.1985	04.1987	AKE	1	54	13		X164077	X164078
-----------------------------------	--	---------	---------	-----	---	----	----	--	---------	---------

WILDCAT/ROCKY (F75)

Tout / All / Alle / Tutti / Todos		02.1985	04.1987	AKE	1	54	13		X164077	X164078
-----------------------------------	--	---------	---------	-----	---	----	----	--	---------	---------

YRV (M2)

1.3 GTi		07.2002		AISIN	1	51	16		X134073	X134074
---------	--	---------	--	-------	---	----	----	--	---------	---------



DAIMLER



2.8 - 5.3

3.6		10.1986	09.1989	GIRL-TRW	1	60	22		X374375	X374376
-----	--	---------	---------	----------	---	----	----	--	---------	---------

X=1 : SNRA - X=2 : EAI - X=3 : SERA - X=4 : SEEC - X=5 : NEOTO - X=6 : STARTCAR

Affectations par Marques

Vehicule application - Zuordnung nach Marke und Fahrzeuge - Applicazione per marca e veicolo - Aplicacion por marca y vehiculo



DAIMLER



2.8 - 5.3

Double Six 5.3		10.1986	09.1992	GIRL-TRW	4	48	24,2		X374217	X374218
Sovereign 2.8		10.1969	10.1973	GIRL-TRW	3	40/57	12,7		X374321	X374322
		10.1969	10.1973	GIRL-TRW	3	40/57	24		X374509	X374510
		10.1969	10.1973	GIRL-TRW	4	48	24,2		X374217	X374218
Sovereign 3.4		05.1975	12.1978	GIRL-TRW	3	40/57	12,7		X374321	X374322
		05.1975	12.1978	GIRL-TRW	3	40/57	24		X374509	X374510
		05.1975	12.1978	GIRL-TRW	4	48	24,2		X374217	X374218
Sovereign 4.2		09.1973	10.1975	GIRL-TRW	3	40/57	12,7		X374321	X374322
		09.1973	10.1975	GIRL-TRW	3	40/57	24		X374509	X374510
		09.1973	10.1975	GIRL-TRW	4	48	24,2		X374217	X374218
Tout / All / Alle / Tutti / Todos		10.1969	09.1992	GIRL-TRW	2	43	12,8		X375117	X375118

COUPE

Sovereign 4.2		09.1973	12.1977	GIRL-TRW	3	40/57	12,7		X374321	X374322
		09.1973	12.1977	GIRL-TRW	3	40/57	24		X374509	X374510
		09.1973	12.1977	GIRL-TRW	4	48	24,2		X374217	X374218
Tout / All / Alle / Tutti / Todos		09.1973	12.1977	GIRL-TRW	2	43	12,8		X375117	X375118

DAIMLER (XJ4_ / XJ 40, 81)

Tout / All / Alle / Tutti / Todos		10.1989	09.1994	GIRL-TRW	1	60	22		X374375	X374376
-----------------------------------	--	---------	---------	----------	---	----	----	--	---------	---------



DE TOMASO



PANTERA

Tout / All / Alle / Tutti / Todos		01.1971	12.1993	GIRL-TRW	4	34/43			X374493	X374494
		01.1971	12.1993	GIRL-TRW	2	43			X375169	X375170



DODGE



CALIBER

Tout / All / Alle / Tutti / Todos		06.2006		AKE	1	57	26		X164317	X164318
		06.2006		AKE	1	35	10/Ø262		X165193	X165194

CARAVAN (RG_)

Tout / All / Alle / Tutti / Todos		04.2001	12.2007	ATE	1	66	28/Ø281		X224593	X224594
		04.2001	12.2007	ATE	1	42	12,5		X225247	X225248

JOURNEY

Tout / All / Alle / Tutti / Todos		06.2008		GIRL-TRW	1	66	28		X374729	X374730
		06.2008		GIRL-TRW	1	43	12		X375473	X375474

NITRO

Tout / All / Alle / Tutti / Todos		09.2006	04.2012	GIRL-TRW	1	66	28		X374729	X374730
		09.2006	04.2012	GIRL-TRW	1	66	28		X374731	X374732
		09.2006	12.2012	GIRL-TRW	1	48	12		X375435	X375436

Affectations par Marques

Vehicule application - Zuordnung nach Marke und Fahrzeuge - Applicazione per marca e veicolo - Aplicacion por marca y vehiculo



ELVA



COURIER

1.5		01.1962	12.1963	GIRL-TRW	2	43			X374307	X374308
1.8		01.1962	12.1963	GIRL-TRW	2	43			X374307	X374308

T Type

1.5		01.1963	12.1965	GIRL-TRW	2	48			X374487	X374488
1.8		01.1963	12.1965	GIRL-TRW	2	48			X374487	X374488



FERRARI



250 GT

Tout / All / Alle / Tutti / Todos		01.1956		LOCK	2	54			X464119	X464120
-----------------------------------	--	---------	--	------	---	----	--	--	---------	---------

308

308 GT 2+2		09.1973		ATE	2	48			X224507	X224508
		09.1973		ATE	2	38			X225199	X225200
308 GTB / GTS		04.1981	08.1985	ATE	1	48			X225299	X225300

328

328 GTB / GTS		09.1985	08.1989	ATE	1	48			X225299	X225300
---------------	--	---------	---------	-----	---	----	--	--	---------	---------

348 TS

3.4		01.1992		ATE	4	36/40			X224661	X224662
		01.1992		ATE	4	36/40			X225341	X225342

365

365 GT		11.1967		GIRL-TRW	3	43/60			X374513	X374514
		11.1967		GIRL-TRW	3	27/38			X375243	X375244
		01.1969		ATE	4	34			X225135	X225136
365 GT4 2+2		01.1969		ATE	4	40			X224511	X224512
365 GTB		01.1969		ATE	4	34			X225135	X225136
365 GTB4 (DAYTONA)		01.1969		ATE	4	40			X224511	X224512
		01.1969		ATE	4	34			X225135	X225136
365 GTC		11.1967		GIRL-TRW	3	43/60			X374513	X374514
		11.1967		GIRL-TRW	3	27/38			X375243	X375244
		01.1969		ATE	4	35			X225135	X225136
365 GTC4		01.1969		ATE	4	34			X225135	X225136
365 GTS		01.1969		ATE	4	34			X225135	X225136

365 GT4 2+2

365 GT4 2+2		01.1969		ATE	4	34			X225207	X225208
-------------	--	---------	--	-----	---	----	--	--	---------	---------

400 GT

Tout / All / Alle / Tutti / Todos		01.1976	12.1979	ATE	4	42			X224551	X224552
		01.1976	12.1979	ATE	4	34			X225207	X225208

Affectations par Marques

Vehicule application - Zuordnung nach Marke und Fahrzeuge - Applicazione per marca e veicolo - Aplicacion por marca y vehiculo



FERRARI



512BB

4.9		08.1976	12.1981	ATE	4	40			X224511	X224512
		08.1976	12.1981	ATE	4	42			X224551	X224552
		07.1981	08.1984	ATE	4	40			X224511	X224512
		07.1981	08.1984	ATE	4	42			X224551	X224552
		08.1976	12.1981	ATE	4	34			X225207	X225208
		07.1981	08.1984	ATE	4	34			X225207	X225208

DINO

246 GT		10.1969	08.1973	ATE	2	48			X224507	X224508
		10.1969	08.1973	ATE	2	38			X225199	X225200
246 GTS		10.1969	08.1973	ATE	2	48			X224507	X224508
		10.1969	08.1973	ATE	2	38			X225199	X225200

MONDIAL

Tout / All / Alle / Tutti / Todos		07.1980	04.1981	ATE	2	48			X224305	X224306
		07.1980	12.1993	ATE	2	38			X225131	X225132
		04.1981	12.1993	ATE	1	48			X225299	X225300

TESTAROSSA

Tout / All / Alle / Tutti / Todos		01.1984		ATE	4	40			X224621	X224622
		01.1984		ATE	4	34			X225297	X225298



FIAT



124 / 125

Tout / All / Alle / Tutti / Todos		01.1965	12.1967	BENDIX	1	48	10		->361483	X254177	X254178
		01.1967	05.1980	BENDIX	1	48	10,8		361484->	X254199	X254200
		01.1967	05.1980	BENDIX	1	34	10,8			X255003	X255004

127

Tout / All / Alle / Tutti / Todos		01.1977	12.1986	BENDIX	1	48	10			X254023	X254024
		01.1977	12.1986	BENDIX	1	48	10,8			X254189	X254190
		01.1977	12.1986	BENDIX	1	54	10			X254033	X254034

128

Tout / All / Alle / Tutti / Todos		03.1969	12.1981	BENDIX	1	48	10			X254023	X254024
-----------------------------------	--	---------	---------	--------	---	----	----	--	--	---------	---------

130

Tout / All / Alle / Tutti / Todos		06.1969	12.1978	BENDIX	1	38				X254219	X254220
		06.1969	12.1978	BENDIX	1	45				X255061	X255062

131

1.4 Mirafiori		11.1980	01.1984	BENDIX	1	48	10,8			X254085	X254086
		11.1980	01.1984	BENDIX	1	48	10,8			X254191	X254192
1.6		11.1976	04.1985	BENDIX	1	48	10,8			X254085	X254086
		11.1976	04.1985	BENDIX	1	48	10,8			X254191	X254192
2.0 Racing		06.1978	12.1981	BENDIX	1	48	10,8			X254085	X254086
2.0 Super		01.1981	12.1984	BENDIX	1	48	10,8			X254085	X254086

X=1 : SNRA - X=2 : EAI - X=3 : SERA - X=4 : SEEAC - X=5 : NEOTO - X=6 : STARTCAR

Affectations par Marques

Vehicule application - Zuordnung nach Marke und Fahrzeuge - Applicazione per marca e veicolo - Aplicacion por marca y vehiculo



FIAT



132

Tout / All / Alle / Tutti / Todos		04.1972	12.1981	BENDIX	1	48	10		X254023	X254024
		04.1972	12.1981	BENDIX	1	48	10		X254199	X254200
		04.1972	12.1981	BENDIX	1	48	10,8		X254189	X254190
		04.1972	12.1981	BENDIX	1	34	10,8		X255003	X255004
		04.1972	12.1981	BENDIX	1	38	10,8		X255035	X255036

242-SERIE

Tout / All / Alle / Tutti / Todos		07.1974	12.1984	CITROEN	2	60	20		X314017	X314018
		07.1974	12.1984	CITROEN	2	42	9		X315013	X315014

500

0.5		01.1960	12.1966	BENDIX	1	48	10		X254023	X254024
-----	--	---------	---------	--------	---	----	----	--	---------	---------

500 (312_)

0.9		10.2013		BOSCH	1	54	22/Ø257		X274071	X274072
1.2		10.2007		BENDIX	1	48	11		X254145	X254146
1.2 LPG		12.2010		BENDIX	1	48	11		X254145	X254146
1.3 D Multijet		10.2007		BOSCH	1	48	20		X274083	X274084
		10.2007		BOSCH	1	54	22/Ø257		X274071	X274072
1.4		10.2007		BOSCH	1	54	22/Ø257		X274071	X274072
1.4 Abarth		08.2008		BOSCH	1	54	22/Ø284		X274079	X274080
Tout / All / Alle / Tutti / Todos		10.2007		GIRL-TRW	1	34	11		X375345	X375346

500 C (312_)

0.9		12.2013		BOSCH	1	54	22/Ø257		X274071	X274072
1.2		09.2009		BOSCH	1	48	20		X274083	X274084
1.3 D Multijet		09.2009		BOSCH	1	48	20		X274083	X274084
		09.2009		BOSCH	1	54	22/Ø257		X274071	X274072
1.4		09.2009		BOSCH	1	54	22/Ø257		X274071	X274072
		01.2011		BOSCH	1	54	22/Ø284		X274079	X274080
1.4 Abarth		09.2009		BOSCH	1	54	22/Ø284		X274079	X274080
Tout / All / Alle / Tutti / Todos		09.2009		GIRL-TRW	1	34	11		X375345	X375346

500 L (312_)

0.9		09.2012		BOSCH	1	54	22/Ø284		X274079	X274080
0.9 Natural Power		03.2013		BOSCH	1	54	22/Ø284		X274079	X274080
1.3 D Multijet		09.2012		BOSCH	1	54	22/Ø284		X274079	X274080
1.4		09.2012		BOSCH	1	54	22/Ø284		X274079	X274080
		10.2013		ATE	1	57	28		X224851	X224852
1.4 LPG		02.2014		ATE	1	57	28		X224851	X224852
1.6 D Multijet		09.2012		BOSCH	1	54	22/Ø284		X274079	X274080
		09.2013		ATE	1	57	28		X224851	X224852
Tout / All / Alle / Tutti / Todos		09.2012		GIRL-TRW	1	38	10		X375475	X375476

500 X (312_)

Tout / All / Alle / Tutti / Todos		09.2014		ATE	1	57	26		X224853	X224854
-----------------------------------	--	---------	--	-----	---	----	----	--	---------	---------

Affectations par Marques

Vehicule application - Zuordnung nach Marke und Fahrzeuge - Applicazione per marca e veicolo - Aplicacion por marca y vehiculo

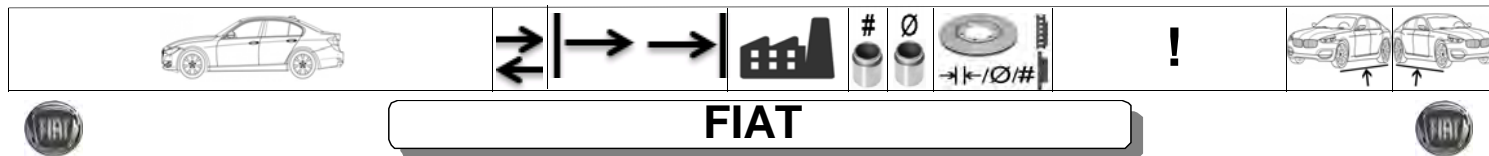

850

Tout / All / Alle / Tutti / Todos		03.1965	10.1972	BENDIX	1	45	10		X254167	X254168
		03.1965	10.1972	BENDIX	1	45	10		X254169	X254170
		03.1965	10.1972	BENDIX	1	48	10		X254253	X254254

ARGENTA (132A)

Tout / All / Alle / Tutti / Todos		06.1978	07.1986	GIRL-TRW	1	48	12		X374155	X374156
		06.1978	07.1986	GIRL-TRW	1	54	12		X374265	X374266
		06.1978	07.1986	GIRL-TRW	1	54	12		X374469	X374470
		06.1978	07.1986	BENDIX	1	38	10,8		X255059	X255060

BARCETTA (183)

1.8 16V		04.1995	05.2005	ATE	1	54	20		X224283	X224284
		04.1995	03.1997	GIRL-TRW	1	54	20		X374267	X374268
		04.1995	05.2005	GIRL-TRW	1	34	11	#ID: 4753 4754	X375083	X375084
		04.1995	05.2005	GIRL-TRW	1	34	11	#ID: 941 942	X375033	X375034
		04.1995	05.2005	GIRL-TRW	1	34	11		X375289	X375290

BRAVA (182)

Tout / All / Alle / Tutti / Todos		10.1995	10.2001	ATE	1	54	12		X224431	X224432
		10.1995	10.2001	ATE	1	54	20		X224283	X224284

BRAVO I (182)

2.0 HGT 20V		09.1995	10.2001	ATE	1	54	22/Ø284		X224285	X224286
Tout / All / Alle / Tutti / Todos		09.1995	10.2001	ATE	1	54	12		X224431	X224432
		09.1995	10.2001	ATE	1	54	20/Ø257		X224283	X224284
		09.1995	10.2001	GIRL-TRW	1	34	11	#ID: 4753 4754	X375083	X375084
		09.1995	10.2001	GIRL-TRW	1	34	11	#ID: 941 942	X375033	X375034
		09.1995	10.2001	GIRL-TRW	1	34	11		X375289	X375290

BRAVO II (198)

1.4		04.2007	12.2014	BOSCH	1	54	22/Ø257		X274031	X274032
1.4 16V		03.2008		BOSCH	1	57	26/Ø281		X274035	X274036
1.4 LPG		11.2009	12.2014	BOSCH	1	54	22/Ø257		X274031	X274032
1.4 T-Jet		09.2007	12.2014	BOSCH	1	54	22/Ø284		X274033	X274034
		09.2007	12.2014	BOSCH	1	57	26/Ø281		X274035	X274036
1.6 D Multijet		03.2008	12.2014	BOSCH	1	54	22/Ø284		X274033	X274034
1.9 D Multijet		11.2006	12.2009	BOSCH	1	54	22/Ø284		X274033	X274034
		04.2007	12.2014	BOSCH	1	57	26/Ø281		X274035	X274036
2.0 D Multijet		09.2008	12.2014	BOSCH	1	57	26/Ø281		X274035	X274036
Tout / All / Alle / Tutti / Todos		11.2006		BOSCH	1	38	10		X275049	X275050

CINQUECENTO (170)

Tout / All / Alle / Tutti / Todos		07.1991	01.1998	BENDIX	1	48	11		X254145	X254146
-----------------------------------	--	---------	---------	--------	---	----	----	--	---------	---------

Affectations par Marques

Vehicule application - Zuordnung nach Marke und Fahrzeuge - Applicazione per marca e veicolo - Aplicacion por marca y vehiculo

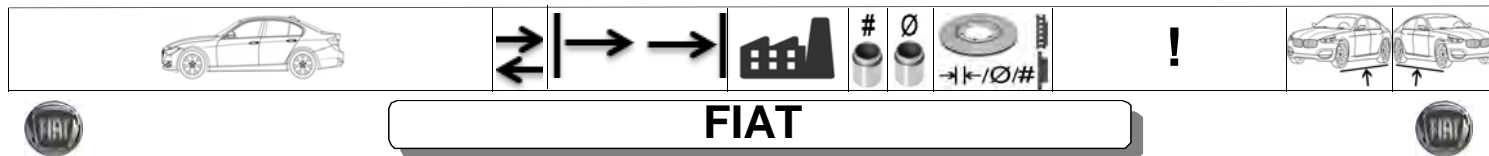

COUPE (FA/175)

Tout / All / Alle / Tutti / Todos		11.1993	08.2000	ATE	1	54	22		X224285	X224286
		11.1993	08.2000	GIRL-TRW	1	54	22		X374397	X374398
		11.1993	08.2000	GIRL-TRW	1	34	11	Fe #ID: 4753 4754	X375083	X375084
		11.1993	08.2000	GIRL-TRW	1	34	11	Fe #ID: 941 942	X375033	X375034
		11.1993	08.2000	GIRL-TRW	1	34	11	Al	X375289	X375290

CROMA (154)

1900 Turbo D i.d. (154.LL, 154.PL)		05.1989	10.1992	GIRL-TRW	1	54	14		X374425	X374426
2000 16V		08.1992	08.1996	GIRL-TRW	1	54	22/Ø257		X374427	X374428
2000 CHT		01.1991	09.1992	GIRL-TRW	1	54	14		X374425	X374426
2000 i.e. (154.AD)		03.1987	09.1992	GIRL-TRW	1	54	14		X374425	X374426
		03.1987	09.1992	GIRL-TRW	1	54	22/Ø257		X374427	X374428
2000 i.e. (154.AM)		03.1986	09.1990	GIRL-TRW	1	54	22/Ø257		X374427	X374428
2000 i.e. (154.AM, 154.LM)		10.1987	08.1996	GIRL-TRW	1	54	22/Ø257		X374427	X374428
2000 i.e. Turbo		11.1986	11.1988	GIRL-TRW	1	54	22/Ø257		X374427	X374428
2000 i.e. Turbo (154.AM)		12.1985	06.1990	GIRL-TRW	1	54	22/Ø257		X374427	X374428
2000 i.e. Turbo (154.AM, 154.LM)		06.1987	08.1996	GIRL-TRW	1	54	22		X374397	X374398
2500 D		12.1985	12.1989	GIRL-TRW	1	54	22/Ø257		X374427	X374428
2500 V6		06.1993	08.1996	GIRL-TRW	1	54	22		X374397	X374398
Tout / All / Alle / Tutti / Todos		10.1985	12.1996	BENDIX	1	36	10		X255031	X255032
		10.1985	12.1996	GIRL-TRW	1	36	10		X375035	X375036

CROMA (194)

1.8 16V		12.2005	03.2006	ATE	1	57	25/Ø285	#ID: 6002	X224635	X224636
		12.2005		ATE	1	57	25/Ø285	#ID: 781 782	X224625	X224626
		12.2005	12.2011	GIRL-TRW	1	41	12		X375405	X375406
1.9 D Multijet		06.2005	03.2006	ATE	1	57	25/Ø285	#ID: 6002	X224635	X224636
		06.2005	10.2007	ATE	1	57	25/Ø285	#ID: 781 782	X224625	X224626
		06.2005	10.2007	GIRL-TRW	1	60	28		X374673	X374674
		06.2005	10.2007	GIRL-TRW	1	41	12		X375405	X375406
		06.2005	10.2007	GIRL-TRW	1	41	20		X375507	X375508
2.2 16V		06.2005	03.2006	ATE	1	57	25/Ø285	#ID: 6002	X224635	X224636
		06.2005		ATE	1	57	25/Ø285	#ID: 781 782	X224625	X224626
		06.2005	12.2013	GIRL-TRW	1	41	12		X375405	X375406
2.4 D Multijet		06.2005	12.2011	GIRL-TRW	1	60	28		X374673	X374674
		06.2005	12.2011	GIRL-TRW	1	41	20		X375507	X375508

DOBLO (119_, 223_)

1.2 (223AXA1A)		03.2001	10.2005	ATE	1	54	20		X224531	X224532
1.3 D Multijet		10.2005	07.2009	BOSCH	1	54	22/Ø257		X274071	X274072
		10.2005	07.2009	BOSCH	1	54	22/Ø284		X274079	X274080
1.3 JTD		05.2005	08.2013	BOSCH	1	54	22/Ø257		X274071	X274072
		05.2005	08.2013	BOSCH	1	54	22/Ø284		X274079	X274080

Affectations par Marques

Vehicule application - Zuordnung nach Marke und Fahrzeuge - Applicazione per marca e veicolo - Aplicacion por marca y vehiculo

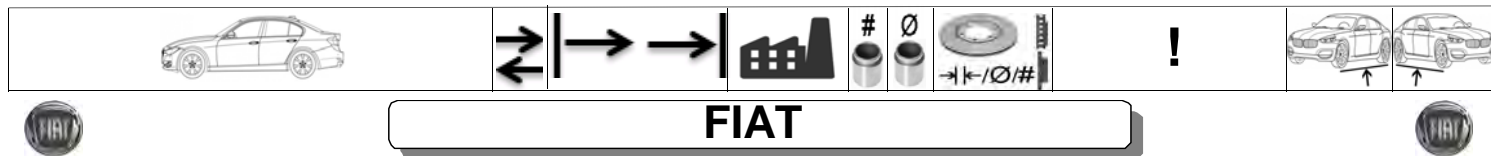

DOBLO (119_, 223_)

1.3 JTD 16V		12.2004	05.2005	ATE	1	54	20		X224531	X224532
		12.2004	05.2005	BOSCH	1	54	22/Ø257		X274071	X274072
		12.2004	05.2005	BOSCH	1	54	22/Ø284		X274079	X274080
1.4		10.2005	08.2013	BOSCH	1	54	22/Ø257		X274071	X274072
		10.2005	08.2013	BOSCH	1	54	22/Ø284		X274079	X274080
1.6 16V		10.2001	12.2004	ATE	1	54	20		X224531	X224532
		01.2005		BOSCH	1	54	22/Ø257		X274071	X274072
		01.2005		BOSCH	1	54	22/Ø284		X274079	X274080
1.6 Natural Power		09.2002	12.2004	ATE	1	54	20		X224531	X224532
		01.2005		BOSCH	1	54	22/Ø257		X274071	X274072
		01.2005		BOSCH	1	54	22/Ø284		X274079	X274080
1.9 D		03.2001	10.2005	ATE	1	54	20		X224531	X224532
1.9 D Multijet		10.2005	07.2009	BOSCH	1	54	22/Ø257		X274071	X274072
		10.2005	07.2009	BOSCH	1	54	22/Ø284		X274079	X274080
1.9 JTD		07.2003	12.2004	ATE	1	54	20		X224531	X224532
		01.2005		BOSCH	1	54	22/Ø257		X274071	X274072
		01.2005		BOSCH	1	54	22/Ø284		X274079	X274080

DOBLO (152, 263)

1.3 D Multijet		02.2010		ATE	1	57	28		X224851	X224852
		02.2010		BOSCH	1	54	22		X274079	X274080
1.4		02.2010		ATE	1	57	28		X224851	X224852
1.4 Natural Power		02.2010		ATE	1	57	28		X224851	X224852
1.6 D Multijet		02.2010		ATE	1	57	28		X224851	X224852
		02.2010		BOSCH	1	54	22		X274079	X274080
2.0 D Multijet		02.2010		ATE	1	57	28		X224851	X224852

DUCATO (280)

Tout / All / Alle / Tutti / Todos		10.1981	08.1994	GIRL-TRW	2	^{38/48}	13		X374011	X374012
		10.1981	08.1994	GIRL-TRW	2	^{38/48}	16/Ø256		X374013	X374014
		10.1981	08.1994	GIRL-TRW	2	^{43/48}	16/Ø290		X374159	X374160

DUCATO I (230/230L)

Tout / All / Alle / Tutti / Todos		03.1994	04.2002	GIRL-TRW	2	^{40/48}	18			X374223	X374224
		03.1994	04.2002	GIRL-TRW	2	^{40/48}	18			X374225	X374226
		03.1994	04.2002	GIRL-TRW	2	^{40/48}	24			X374227	X374228
		03.1994	04.2002	GIRL-TRW	2	^{40/48}	24			X374229	X374230
		04.1997		BREMBO	1	46	16			X285031	X285032

DUCATO II (244, Z_)

Tout / All / Alle / Tutti / Todos		04.2002	07.2006	BREMBO	2	^{44/48}	24/Ø280			>1400	X284045	X284046
		04.2002	07.2006	BREMBO	2	^{44/48}	24/Ø280			>1400	X284047	X284048
		04.2002	07.2006	BREMBO	2	^{46/52}	24/Ø300			>1800	X284029	X284030
		04.2002	07.2006	BREMBO	2	^{46/52}	24/Ø300			>1800	X284049	X284050
		04.2002	07.2006	BREMBO	1	46	16				X285031	X285032

Affectations par Marques

Vehicule application - Zuordnung nach Marke und Fahrzeuge - Applicazione per marca e veicolo - Aplicacion por marca y vehiculo



FIAT



DUCATO III (250, 290)

Tout / All / Alle / Tutti / Todos		07.2006		BREMBO	2	^{44/48}	24/Ø280		X284093	X284094
		07.2006		BREMBO	2	^{46/52}	24/Ø300		X284095	X284096
		07.2006		BREMBO	2	^{46/52}	28/Ø280		X284117	X284118
		07.2006		BREMBO	2	^{46/52}	32/Ø300		X284097	X284098
		07.2006		BOSCH	1	48	16		Avec capteur de plaquette X275081	X275082
		07.2006		BOSCH	1	48	16		Sans capteur de plaquette X275051	X275052

ELBA (146_)

Tout / All / Alle / Tutti / Todos		10.1985	10.1997	ATE	1	48	12		X224287	X224288
		10.1985	10.1997	ATE	1	54	12		X224597	X224598

FIORINO (146)

1.3		01.1988	12.1994	ATE	1	48	12		X224287	X224288
1.4		05.1994	05.2001	ATE	1	54	12		X224597	X224598
1.6		01.1994	05.2001	ATE	1	54	12		X224597	X224598
1.7 D		01.1988	10.1992	ATE	1	48	12		X224287	X224288
		10.1993	10.1999	ATE	1	54	12		X224597	X224598
1.7 TD		11.1996	05.2001	ATE	1	54	12		X224597	X224598
60 1.1		05.1988	12.1993	ATE	1	48	12		X224287	X224288
60 1.7 D		05.1988	05.2000	ATE	1	48	12		X224287	X224288
65 1.7 TD		01.1997	05.2001	ATE	1	54	12		X224597	X224598
70 1.3		01.1988	12.1994	ATE	1	48	12		X224287	X224288
70 i.e. 1.4		05.1994	05.2001	ATE	1	54	12		X224597	X224598
75 i.e. 1.5		05.1988	12.1993	ATE	1	48	12		X224287	X224288
75 i.e. 1.6		10.1993	05.2001	ATE	1	54	12		X224597	X224598

FIORINO (147)

Tout / All / Alle / Tutti / Todos		12.1987		ATE	1	48	12		X224287	X224288
-----------------------------------	--	---------	--	-----	---	----	----	--	---------	---------

FIORINO (225)

1.3 D Multijet		11.2007		BOSCH	1	54	22/Ø257		X274071	X274072
		07.2009		BOSCH	1	54	22/Ø284		X274079	X274080
1.4		11.2007		BOSCH	1	54	22/Ø257		X274071	X274072
1.4 Natural Power		10.2009		BOSCH	1	54	22/Ø257		X274071	X274072

FREEMONT (JC)

Tout / All / Alle / Tutti / Todos		08.2011		GIRL-TRW	1	66	28		X374729	X374730
-----------------------------------	--	---------	--	----------	---	----	----	--	---------	---------

IDEA

1.2 16V		01.2004	12.2010	BOSCH	1	54	22/Ø257		X274031	X274032
1.3 D Multijet		10.2005	12.2012	BOSCH	1	54	22/Ø284		X274081	X274082
1.3 JTD		01.2004	12.2011	BOSCH	1	54	22/Ø257		X274031	X274032
1.4		12.2003	12.2012	BOSCH	1	54	22/Ø257		X274031	X274032
1.4 16V		01.2004	12.2012	BOSCH	1	54	22/Ø257		X274031	X274032
1.4 LPG		03.2009	12.2012	BOSCH	1	54	22/Ø257		X274031	X274032
1.6 D Multijet		05.2008	12.2012	BOSCH	1	54	22/Ø284		X274081	X274082
1.9 JTD		01.2004	12.2010	BOSCH	1	54	22/Ø284		X274081	X274082

X=1 : SNRA - X=2 : EAI - X=3 : SERA - X=4 : SEEAC - X=5 : NEOTO - X=6 : STARTCAR

Affectations par Marques

Vehicule application - Zuordnung nach Marke und Fahrzeuge - Applicazione per marca e veicolo - Aplicacion por marca y vehiculo

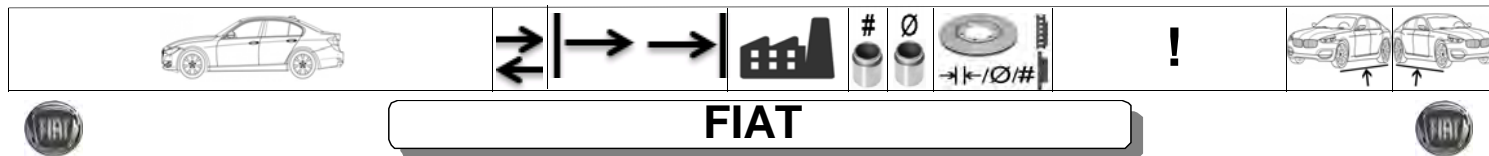

LINEA (323)

1.3 D Multijet		06.2007		BOSCH	1	54	22/Ø257		X274071	X274072
1.4		06.2007		BOSCH	1	54	22/Ø257		X274071	X274072
1.4 T-Jet		09.2007		BOSCH	1	54	22/Ø284		X274079	X274080
1.6 D Multijet		06.2009		BOSCH	1	54	22/Ø284		X274079	X274080
Tout / All / Alle / Tutti / Todos		09.2007		GIRL-TRW	1	38	10/Ø251	#ID: 912 913	X375247	X375248

MAREA (185)

1.2 16V		10.1998	05.2002	ATE	1	54	12		X224431	X224432
		10.1998	08.2000	ATE	1	54	20/Ø257		X224283	X224284
1.4 12V		09.1996	02.1999	ATE	1	54	12		X224431	X224432
		09.1996	02.1999	ATE	1	54	20/Ø257		X224283	X224284
1.6		03.1999	08.2002	ATE	1	54	12		X224431	X224432
		09.2000	08.2002	ATE	1	54	20/Ø257		X224283	X224284
1.6 (100) 16V Bipower		04.1999	05.2002	ATE	1	54	20/Ø257		X224283	X224284
1.6 16V		04.1997	02.1999	ATE	1	54	12		X224431	X224432
1.6 SX		09.2000	08.2002	ATE	1	54	12		X224431	X224432
		09.2000	08.2002	ATE	1	54	20/Ø257		X224283	X224284
1.8 16V		09.1996	08.2000	ATE	1	54	20/Ø257		X224283	X224284
1.9 JTD		04.1999	08.2000	ATE	1	54	20/Ø257		X224283	X224284
1.9 TD 100		09.1996	02.1999	ATE	1	54	20/Ø257		X224283	X224284
1.9 TD 75		09.1996	08.2000	ATE	1	54	12		X224431	X224432
2.0 (150) 20V		09.1996	05.2002	ATE	1	54	22/Ø284		X224285	X224286
2.0 (155) 20V		04.1999	08.2000	ATE	1	54	22/Ø284		X224285	X224286
2.4 JTD (130)		04.1999	08.2000	ATE	1	54	22/Ø284		X224285	X224286
2.4 TD (125)		09.1996	04.1999	ATE	1	54	22/Ø284		X224285	X224286
Tout / All / Alle / Tutti / Todos		09.1996	05.2002	GIRL-TRW	1	34	11	Fe	X375083	X375084
		09.1996	05.2002	GIRL-TRW	1	34	11	Al	X375289	X375290

MULTIPLA (186)

1.6		09.2000	12.2005	BOSCH	1	38	10		X275017	X275018
		09.2000	12.2005	BOSCH	1	38	10		X275049	X275050
1.6 16V (186AGB1A)		01.2006	06.2010	BOSCH	1	38	10		X275049	X275050
1.6 16V Bipower (186AMB1A)		04.1999	09.2003	BOSCH	1	38	10		X275017	X275018
1.6 16V Bipower (186AXC1A)		10.2001	06.2010	BOSCH	1	38	10		X275049	X275050
		10.2001	12.2005	BOSCH	1	38	10		X275017	X275018
1.9 JTD (105) (186AXB1A)		04.1999	08.2000	BOSCH	1	38	10		X275017	X275018
1.9 JTD (110)		03.2001	07.2002	BOSCH	1	38	10		X275017	X275018
1.9 JTD (115)		07.2002	12.2005	BOSCH	1	38	10		X275017	X275018
		01.2006	06.2010	BOSCH	1	38	10		X275049	X275050
1.9 JTD (186AXE1A)		04.2002	12.2005	BOSCH	1	38	10		X275017	X275018
		01.2006	06.2010	BOSCH	1	38	10		X275049	X275050
Tout / All / Alle / Tutti / Todos		04.1999	06.2010	ATE	1	54	22/Ø284		X224285	X224286
		04.1999	06.2010	BOSCH	1	54	22/Ø284		X274081	X274082

X=1 : SNRA - X=2 : EAI - X=3 : SERA - X=4 : SEEAC - X=5 : NEOTO - X=6 : STARTCAR

Affectations par Marques

Vehicule application - Zuordnung nach Marke und Fahrzeuge - Applicazione per marca e veicolo - Aplicacion por marca y vehiculo

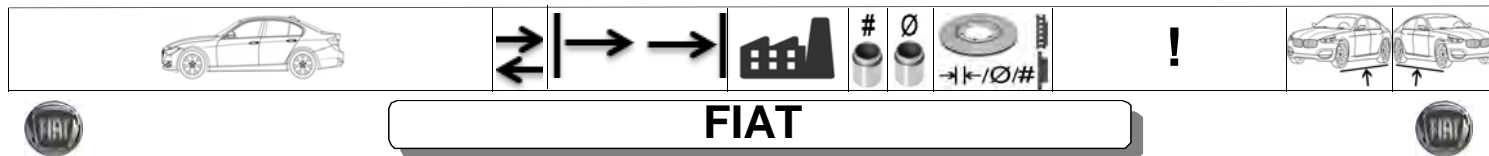

PALIO (178BX)										
Tout / All / Alle / Tutti / Todos		04.1996	12.2007	ATE	1	54	20		X224531	X224532

PALIO (178DX)										
1.2		09.2001	10.2004	ATE	1	54	20		X224531	X224532
1.2 (178DX.G1A)		04.1996	03.1998	ATE	1	48	20		X224543	X224544
		04.1998	02.2001	ATE	1	54	20		X224531	X224532
1.2 Break		09.2001	10.2004	ATE	1	54	20		X224545	X224546
1.4		07.1997	03.1998	ATE	1	48	20		X224543	X224544
		04.1998	08.2001	ATE	1	54	20		X224531	X224532
1.6 16V (178DX.D1A)		04.1996	02.2001	ATE	1	54	20		X224531	X224532
1.6 16V (178DYC1A06)		02.2001	10.2004	ATE	1	54	20		X224531	X224532
1.6 BREAK		02.2001	10.2004	ATE	1	54	20		X224545	X224546
1.7 TD (178DX.H1A)		04.1996	03.2001	ATE	1	48	20		X224543	X224544
		04.1996	03.2001	ATE	1	54	20		X224531	X224532
1.9 D (178DYD1A07)		03.2001	08.2002	ATE	1	54	20		X224531	X224532
1.9 D Break		03.2001	08.2002	ATE	1	54	20		X224545	X224546
1.9 JTD		09.2001	10.2004	ATE	1	54	20		X224531	X224532

PANDA I (141_)										
Tout / All / Alle / Tutti / Todos		07.1981	10.1985	BENDIX	1	48	10,8		X254085	X254086
		11.1986	07.2004	BENDIX	1	48	10,8		X254093	X254094

PANDA I (141_) SELECTA										
Tout / All / Alle / Tutti / Todos		04.1991	07.2004	GIRL-TRW	1	48	12		X374161	X374162

PANDA II (169)										
1.1		09.2003	12.2012	BENDIX	1	48	11/Ø240		X254145	X254146
1.2		09.2003	12.2012	BENDIX	1	48	11/Ø240		X254145	X254146
1.2 4x4		09.2004	12.2012	BOSCH	1	48	20/Ø240		X274083	X274084
		11.2009	12.2012	BENDIX	1	48	11/Ø240		X254145	X254146
		09.2010	12.2012	BOSCH	1	54	22/Ø257		X274071	X274072
1.2 Bi-Power / Natural Power		09.2004	12.2012	GIRL-TRW	1	34	11		X375345	X375346
		01.2007	12.2012	BOSCH	1	48	20/Ø240		X274083	X274084
1.2 LPG		04.2009	12.2012	BENDIX	1	48	11/Ø240		X254145	X254146
1.3 D Multijet		09.2003	12.2012	BOSCH	1	48	20/Ø240		X274083	X274084
		09.2003	12.2012	GIRL-TRW	1	34	11		X375345	X375346
1.3 D Multijet 4x4		10.2004	12.2012	BOSCH	1	48	20/Ø240		X274083	X274084
		10.2004	12.2012	BOSCH	1	54	22/Ø257		X274071	X274072
1.3 D Multijet 4x4 (70)		10.2004	12.2012	GIRL-TRW	1	34	11		X375469	X375470
1.3 D Multijet 4x4 (75)		09.2010	12.2012	GIRL-TRW	1	34	11		X375345	X375346
1.3 JTD		03.2004	12.2012	BOSCH	1	48	20/Ø240		X274083	X274084
1.3 Multijet 4x4		01.2006	12.2012	BOSCH	1	48	20/Ø240		X274083	X274084
1.4		10.2006	12.2011	BOSCH	1	54	22/Ø257		X274071	X274072
		10.2006	12.2012	GIRL-TRW	1	34	11		X375345	X375346

Affectations par Marques

Vehicule application - Zuordnung nach Marke und Fahrzeuge - Applicazione per marca e veicolo - Aplicacion por marca y vehiculo



FIAT



PANDA II (169)

1.4 Bi-Power / Natural Power		09.2010	12.2012	BENDIX	1	48	11/Ø240		X254145	X254146
		09.2010	12.2012	BOSCH	1	48	20/Ø240		X274083	X274084
1.4 Natural Power		10.2009	12.2012	BOSCH	1	48	20/Ø240		X274083	X274084

PANDA III (312, 319, 519)

Tout / All / Alle / Tutti / Todos		02.2012		ATE	1	54	22		X224855	X224856
		02.2012		GIRL-TRW	1	34	11		X375345	X375346

PENNY (257) VAN

Tout / All / Alle / Tutti / Todos		01.1986	12.1990	ATE	1	48	12		X224287	X224288
-----------------------------------	--	---------	---------	-----	---	----	----	--	---------	---------

PUNTO (176)

1.2 16V		04.1997	09.1999	ATE	1	48	12/Ø257,5		X224533	X224534
		04.1997	09.1999	BENDIX	1	48	11/Ø240		X254145	X254146
1.4 GT Turbo		01.1994	09.1999	GIRL-TRW	1	54	20/Ø257		X374267	X374268
1.6		01.1994	04.1997	GIRL-TRW	1	48	12/Ø257		X374161	X374162
1.7 D		04.1994	09.1997	GIRL-TRW	1	48	12/Ø257		X374161	X374162
1.7 TD		01.1994	03.1997	ATE	1	48	12/Ø257,5		X224533	X224534
		01.1994	03.1997	GIRL-TRW	1	48	12/Ø257		X374161	X374162
55 1.1		09.1993	09.1999	BENDIX	1	48	11/Ø240		X254145	X254146
60 1.2		01.1994	03.1997	GIRL-TRW	1	48	12/Ø257		X374161	X374162
75 1.2		10.1993	10.1998	BENDIX	1	48	11/Ø240		X254145	X254146
Tout / All / Alle / Tutti / Todos		01.1994	09.1999	GIRL-TRW	1	34	11		X375033	X375034

PUNTO (176C)

60 1.2		04.1994	03.1997	GIRL-TRW	1	48	12/Ø257		X374161	X374162
		05.1995	06.2000	BENDIX	1	48	11/Ø240		X254145	X254146
85 16V 1.2		04.1997	06.2000	ATE	1	48	12/Ø257,5		X224533	X224534
		04.1997	06.2000	BENDIX	1	48	11/Ø240		X254145	X254146
90 1.6		04.1994	04.1997	GIRL-TRW	1	48	12/Ø257		X374161	X374162

PUNTO (176L)

1.1		04.1996	02.2000	BENDIX	1	48	11/Ø240		X254145	X254146
1.7 D		04.1996	02.2000	GIRL-TRW	1	48	12/Ø257		X374161	X374162
1.7 TD		04.1996	02.2000	ATE	1	48	12/Ø257,5		X224533	X224534
		04.1996	02.2000	GIRL-TRW	1	48	12/Ø257		X374161	X374162

PUNTO (188)

1.2		09.1999	12.2010	BENDIX	1	48	11/Ø240		X254145	X254146
1.2 16V		09.1999	12.2006	ATE	1	48	12/Ø257,5		X224533	X224534
		09.1999	12.2006	ATE	1	54	12/Ø257,5		X224431	X224432
1.2 Bifuel		08.2007	10.2011	BENDIX	1	48	11/Ø240		X254145	X254146
1.2 Natural Power		09.2003	12.2011	BENDIX	1	48	11/Ø240		X254145	X254146
1.3 JTD 16V		06.2003	03.2012	ATE	1	54	20/Ø257		X224283	X224284
1.4		09.2003	10.2005	ATE	1	54	20/Ø257		X224283	X224284
1.8 130 HGT		09.1999	10.2005	ATE	1	54	22/Ø257		X224895	X224896

X=1 : SNRA - X=2 : EAI - X=3 : SERA - X=4 : SEEAC - X=5 : NEOTO - X=6 : STARTCAR

Affectations par Marques

Vehicule application - Zuordnung nach Marke und Fahrzeuge - Applicazione per marca e veicolo - Aplicacion por marca y vehiculo

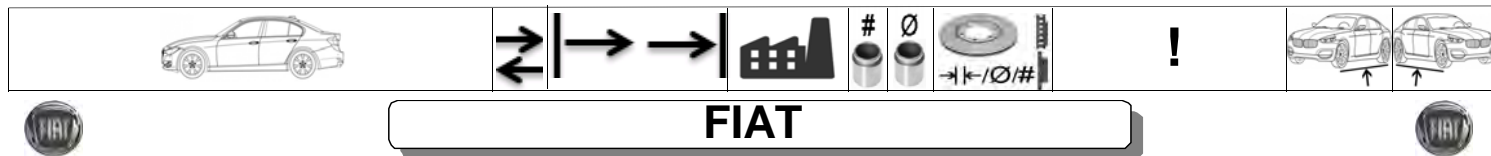

PUNTO (188)

1.9 DS		09.1999	10.2003	ATE	1	54	12/Ø257,5		X224431	X224432
		09.1999	10.2003	ATE	1	54	20/Ø257		X224283	X224284
1.9 JTD (101)		06.2003	10.2005	ATE	1	54	22/Ø284		X224475	X224476
		06.2003	10.2005	BREMBO	4	40	28/Ø330		X284189	X284190
1.9 JTD (80)		09.1999	10.2003	ATE	1	54	20/Ø257		X224283	X224284
1.9 JTD (86)		10.2001	10.2005	ATE	1	54	20/Ø257		X224283	X224284
Tout / All / Alle / Tutti / Todos		09.1999		GIRL-TRW	1	34	11		X375345	X375346

PUNTO (188AX)

1.2		02.2000	10.2009	BENDIX	1	48	11/Ø240		X254145	X254146
1.3 JTD		06.2003	10.2005	ATE	1	54	20/Ø257		X224283	X224284
1.9 D		02.2000	10.2009	ATE	1	54	12/Ø257,5		X224431	X224432
		02.2000	10.2009	ATE	1	54	20/Ø257		X224283	X224284
1.9 JTD		02.2000	10.2009	ATE	1	54	20/Ø257		X224283	X224284

PUNTO (199)

0.9		07.2013		ATE	1	54	22/Ø257		X224855	X224856
0.9 Bifuel		03.2012		ATE	1	54	22/Ø257		X224855	X224856
0.9 Twinair Turbo		03.2012		ATE	1	54	22/Ø257		X224855	X224856
		03.2012		BOSCH	1	54	22/Ø284		X274079	X274080
1.2		03.2012		ATE	1	54	22/Ø257		X224855	X224856
		03.2012		BOSCH	1	54	22/Ø257		X274071	X274072
		03.2012		BOSCH	1	54	22/Ø284		X274079	X274080
1.3 D Multijet		04.2008		ATE	1	54	22/Ø257		X224855	X224856
		04.2008		BOSCH	1	54	22/Ø257		X274071	X274072
		04.2008		BOSCH	1	54	22/Ø284		X274079	X274080
1.4		04.2008		ATE	1	54	22/Ø257		X224855	X224856
		04.2008	05.2010	BOSCH	1	54	22/Ø257		X274071	X274072
1.4 Bifuel		03.2012		ATE	1	54	22/Ø257		X224855	X224856
1.4 LPG		03.2009		ATE	1	54	22/Ø257		X224855	X224856
		03.2009	05.2010	BOSCH	1	54	22/Ø257		X274071	X274072
1.4 Multi Air		03.2012		ATE	1	54	22/Ø257		X224855	X224856
1.4 Natural Power		03.2009		ATE	1	54	22/Ø257		X224855	X224856
		03.2009	05.2010	BOSCH	1	54	22/Ø257		X274071	X274072
		03.2012		BOSCH	1	54	22/Ø284		X274079	X274080
1.4 Turbo Multi Air		03.2012		ATE	1	54	22/Ø257		X224855	X224856
		03.2012		BOSCH	1	54	22/Ø284		X274079	X274080
Tout / All / Alle / Tutti / Todos		03.2012		BOSCH	1	36	10		X275047	X275048

PUNTO / GRANDE PUNTO (199)

1.2		10.2005	12.2011	BENDIX	1	48	11/Ø240		X254145	X254146
		10.2005	12.2008	BOSCH	1	54	12/Ø257		X274077	X274078
		10.2005	05.2012	BOSCH	1	54	22/Ø257		X274071	X274072
		09.2010	05.2012	ATE	1	54	22/Ø257		X224855	X224856

Affectations par Marques

Vehicule application - Zuordnung nach Marke und Fahrzeuge - Applicazione per marca e veicolo - Aplicacion por marca y vehiculo



FIAT



PUNTO / GRANDE PUNTO (199)

1.2 LPG		07.2008		BOSCH	1	54	12/Ø257		X274077	X274078
		07.2008		BOSCH	1	54	22/Ø257		X274071	X274072
1.3 D Multijet		10.2005	12.2008	BOSCH	1	54	12/Ø257		X274077	X274078
		10.2005	06.2013	BOSCH	1	54	22/Ø257		X274071	X274072
		10.2005	12.2012	BOSCH	1	54	22/Ø284		X274079	X274080
		07.2008	12.2011	ATE	1	54	20/Ø257		X224283	X224284
1.4		10.2005		ATE	1	54	20/Ø257		X224283	X224284
		10.2005	07.2007	BOSCH	1	54	12/Ø257		X274077	X274078
		10.2005		BOSCH	1	54	22/Ø257		X274071	X274072
1.4 16V		10.2005	12.2008	BOSCH	1	54	12/Ø257		X274077	X274078
		10.2005	08.2011	BOSCH	1	54	22/Ø257		X274071	X274072
1.4 LPG		12.2008	12.2012	BOSCH	1	54	22/Ø257		X274071	X274072
1.4 Natural Power		07.2008		BOSCH	1	54	12/Ø257		X274077	X274078
		07.2008		BOSCH	1	54	22/Ø257		X274071	X274072
1.4 T-Jet		09.2007	08.2010	BOSCH	1	54	22/Ø284		X274079	X274080
1.6 D Multijet		07.2008	12.2009	BOSCH	1	54	22/Ø284		X274079	X274080
1.9 D Multijet		10.2005	12.2012	BOSCH	1	54	22/Ø284		X274079	X274080
Tout / All / Alle / Tutti / Todos		10.2005		BOSCH	1	36	10		X275047	X275048

PUNTO EVO (199)

1.2		10.2009	02.2012	ATE	1	54	22/Ø257		X224855	X224856
		10.2009	05.2010	BOSCH	1	54	22/Ø257		X274071	X274072
1.3 D Multijet		07.2008		ATE	1	54	22/Ø257		X224855	X224856
		10.2009		BOSCH	1	54	22/Ø284		X274079	X274080
1.4		07.2009	02.2012	ATE	1	54	22/Ø257		X224855	X224856
		07.2009	02.2012	BOSCH	1	54	22/Ø257		X274071	X274072
1.4 16V (105)		10.2009	02.2012	ATE	1	54	22/Ø257		X224855	X224856
		10.2009	02.2012	BOSCH	1	54	22/Ø257		X274071	X274072
1.4 16V (135)		10.2009	02.2012	BOSCH	1	54	22/Ø284		X274079	X274080
1.4 LPG		06.2009	02.2012	ATE	1	54	22/Ø257		X224855	X224856
1.4 Natural Power		10.2009	02.2012	ATE	1	54	22/Ø257		X224855	X224856
1.6 D Multijet		10.2009	02.2012	BOSCH	1	54	22/Ø284		X274079	X274080
Tout / All / Alle / Tutti / Todos		07.2008		BOSCH	1	36	10		X275047	X275048

QUBO (225)

1.3 D Multijet		02.2008		BOSCH	1	54	22/Ø257		X274071	X274072
		07.2010		BOSCH	1	54	22/Ø284		X274079	X274080
1.4		02.2008		BOSCH	1	54	22/Ø257		X274071	X274072
1.4 Natural Power		10.2009		BOSCH	1	54	22/Ø257		X274071	X274072

REGATA

Tout / All / Alle / Tutti / Todos		09.1983	12.1990	BENDIX	1	48	10,8/Ø227		X254085	X254086
		09.1983	12.1990	GIRL-TRW	1	48	12/Ø257		X374161	X374162

RITMO I (138A)

105 Sport 1.6		05.1981	12.1982	GIRL-TRW	1	48	12/Ø257		X374161	X374162
---------------	--	---------	---------	----------	---	----	---------	--	---------	---------

X=1 : SNRA - X=2 : EAI - X=3 : SERA - X=4 : SEEC - X=5 : NEOTO - X=6 : STARTCAR

Affectations par Marques

Vehicule application - Zuordnung nach Marke und Fahrzeuge - Applicazione per marca e veicolo - Aplicacion por marca y vehiculo

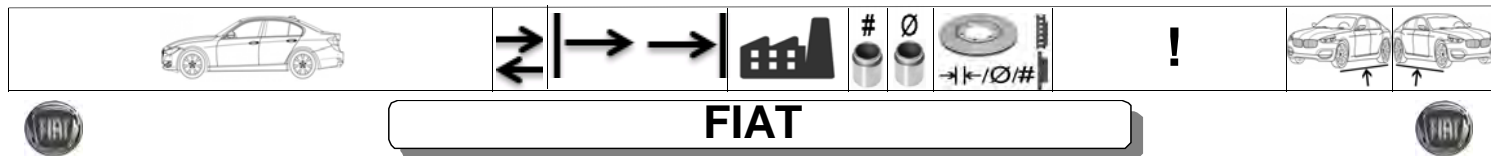

RITMO I (138A)

125 TC Abarth 2.0		11.1981	09.1982	GIRL-TRW	1	48	12/Ø257		X374161	X374162
55 Diesel 1.7		10.1979	09.1982	BENDIX	1	48	10,8/Ø227		X254085	X254086
75 1.5		01.1978	10.1982	BENDIX	1	48	10,8/Ø227		X254085	X254086
75 i.e. 1.5		10.1985	05.1987	BENDIX	1	48	10,8/Ø227		X254085	X254086
85 1.5		01.1981	05.1987	BENDIX	1	48	10,8/Ø227		X254085	X254086

RITMO II (138A)

100 1.6		01.1983	12.1987	GIRL-TRW	1	48	12/Ø257		X374161	X374162
105 1.6		01.1983	12.1987	GIRL-TRW	1	48	12/Ø257		X374161	X374162
125 TC Abarth 2.0		12.1982	12.1987	GIRL-TRW	1	48	12/Ø257		X374161	X374162
130 TC Abarth 2.0		04.1983	12.1987	BENDIX	1	54	20/Ø243		X254037	X254038
60 1.1		10.1982	12.1987	BENDIX	1	48	10,8/Ø227		X254085	X254086
60 Diesel 1.7		10.1982	12.1987	BENDIX	1	48	10,8/Ø227		X254085	X254086
75 1.5		09.1985	12.1988	BENDIX	1	48	10,8/Ø227		X254085	X254086
75 1.5 CAT		09.1985	12.1988	BENDIX	1	48	10,8/Ø227		X254085	X254086
80 Turbo Diesel 1.9		12.1985	12.1987	BENDIX	1	48	10,8/Ø227		X254085	X254086
90 1.6 i.e.		12.1985	12.1987	GIRL-TRW	1	48	12/Ø257		X374161	X374162

SCUDO I (220_)

1.6		02.1996	08.2000	BENDIX	1	57	20/Ø257		X254207	X254208
		02.1996	08.2000	GIRL-TRW	1	57	26/Ø281		X374293	X374294
1.9 D		02.1996	07.1998	BENDIX	1	57	20/Ø257		X254207	X254208
		02.1996	07.1998	GIRL-TRW	1	57	26/Ø281		X374293	X374294
		04.1998	12.2006	GIRL-TRW	1	60	28/Ø285		X374589	X374590
1.9 TD		02.1996	12.2006	BENDIX	1	57	20/Ø257		X254207	X254208
		02.1996	12.2006	GIRL-TRW	1	57	26/Ø281		X374293	X374294
1.9 TD Eco		02.1996	12.2006	BENDIX	1	57	20/Ø257		X254207	X254208
		02.1996	12.2006	GIRL-TRW	1	57	26/Ø281		X374293	X374294
2.0		05.2000	10.2003	BENDIX	1	57	20/Ø257		X254207	X254208
		05.2000	10.2003	GIRL-TRW	1	57	26/Ø281		X374293	X374294
		05.2000	12.2006	GIRL-TRW	1	60	28/Ø285		X374589	X374590
2.0 16V		06.2000	12.2006	BENDIX	1	57	20/Ø257		X254207	X254208
		06.2000	12.2006	GIRL-TRW	1	57	26/Ø281		X374293	X374294
		06.2000	12.2006	GIRL-TRW	1	60	28/Ø285		X374589	X374590
2.0 JTD		12.1999	12.2006	GIRL-TRW	1	60	28/Ø285		X374589	X374590
2.0 JTD 16V		05.1999	12.2006	GIRL-TRW	1	60	28/Ø285		X374589	X374590

SCUDO II (270_)

1.6 D Multijet		01.2007		GIRL-TRW	2	^{45/48}	28/Ø304		X374663	X374664
		01.2007	04.2011	GIRL-TRW	2	^{45/58}	28/Ø280		X374661	X374662
2.0 D Multijet		01.2007		GIRL-TRW	2	^{45/48}	28/Ø304		X374663	X374664
2.0 D Multijet 4x4		01.2007		GIRL-TRW	2	^{45/48}	28/Ø304		X374663	X374664
Tout / All / Alle / Tutti / Todos		01.2007		GIRL-TRW	1	41	14		X375341	X375342

X=1 : SNRA - X=2 : EAI - X=3 : SERA - X=4 : SEEAC - X=5 : NEOTO - X=6 : STARTCAR

Affectations par Marques

Vehicule application - Zuordnung nach Marke und Fahrzeuge - Applicazione per marca e veicolo - Aplicacion por marca y vehiculo

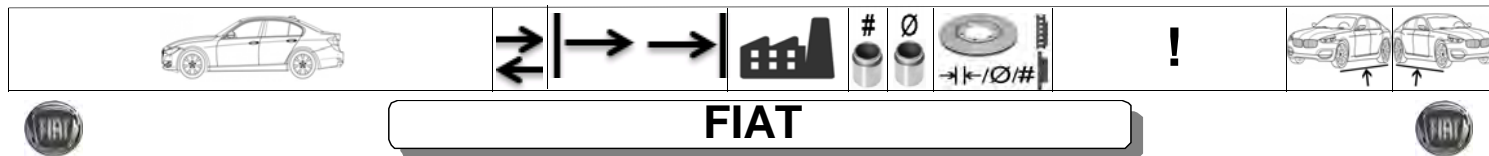

SEDICI

Tout / All / Alle / Tutti / Todos		06.2006	10.2014	GIRL-TRW	1	57	22		X374715	X374716
-----------------------------------	--	---------	---------	----------	---	----	----	--	---------	---------

SEICENTO (187)

0.9		01.1998	01.2010	BENDIX	1	48	11		X254145	X254146
1.1		01.1998	01.2010	BENDIX	1	48	11		X254145	X254146
Elektra		01.1999	04.2004	GIRL-TRW	1	54	12		X374265	X374266
		01.1999	04.2004	GIRL-TRW	1	54	12		X374469	X374470
Elettrica		06.1998	10.2002	GIRL-TRW	1	54	12		X374265	X374266
		06.1998	10.2002	GIRL-TRW	1	54	12		X374469	X374470

SIENA (178_)

Tout / All / Alle / Tutti / Todos		04.1996	12.2009	ATE	1	54	20		X224531	X224532
-----------------------------------	--	---------	---------	-----	---	----	----	--	---------	---------

STILO (192)

1.2 16V		02.2002	10.2003	BOSCH	1	54	22/Ø257		X274031	X274032
		02.2002	10.2003	BOSCH	1	38	10		X275017	X275018
1.4 16V		01.2004	11.2006	BOSCH	1	54	22/Ø257		X274031	X274032
		01.2004	10.2004	BOSCH	1	38	10		X275017	X275018
		11.2004	11.2006	BOSCH	1	38	10		X275049	X275050
1.4 16V MultiWagon		01.2004	08.2008	BOSCH	1	54	22/Ø284		X274033	X274034
		01.2004	10.2004	BOSCH	1	38	10		X275017	X275018
		11.2004	11.2006	BOSCH	1	38	10		X275049	X275050
1.6		04.2005	11.2006	BOSCH	1	54	22/Ø257		X274031	X274032
		04.2005	11.2006	BOSCH	1	38	10		X275049	X275050
1.6 16V		10.2001	11.2006	BOSCH	1	54	22/Ø257		X274031	X274032
		10.2001	10.2004	BOSCH	1	38	10		X275017	X275018
		11.2004	08.2008	BOSCH	1	38	10		X275049	X275050
1.6 16V MultiWagon		01.2003	08.2008	BOSCH	1	54	22/Ø284		X274033	X274034
		10.2001	10.2004	BOSCH	1	38	10		X275017	X275018
		11.2004	08.2008	BOSCH	1	38	10		X275049	X275050
1.8 16V		10.2001	08.2008	BOSCH	1	54	22/Ø284		X274033	X274034
		10.2001	10.2004	BOSCH	1	38	10		X275017	X275018
		11.2004	08.2008	BOSCH	1	38	10		X275049	X275050
1.9 D		09.2004	08.2008	BOSCH	1	54	22/Ø284		X274033	X274034
		09.2004	08.2008	BOSCH	1	38	10		X275049	X275050
1.9 D Multijet (100~120)		09.2005	11.2006	BOSCH	1	54	22/Ø284		X274033	X274034
		09.2005	11.2006	BOSCH	1	38	10		X275049	X275050
1.9 D Multijet (150)		09.2005	11.2006	BOSCH	1	57	26/Ø281		X274035	X274036
		09.2005	11.2006	BOSCH	1	38	10		X275049	X275050
1.9 JTD (126~140)		09.2003	08.2005	BOSCH	1	57	26/Ø281		X274035	X274036
		10.2001	10.2004	BOSCH	1	38	10		X275017	X275018
		11.2004	08.2008	BOSCH	1	38	10		X275049	X275050
1.9 JTD (80~115)		01.2003	08.2005	BOSCH	1	54	22/Ø284		X274033	X274034
		10.2001	10.2004	BOSCH	1	38	10		X275017	X275018
		11.2004	08.2008	BOSCH	1	38	10		X275049	X275050

X=1 : SNRA - X=2 : EAI - X=3 : SERA - X=4 : SEEAC - X=5 : NEOTO - X=6 : STARTCAR

Affectations par Marques

Vehicule application - Zuordnung nach Marke und Fahrzeuge - Applicazione per marca e veicolo - Aplicacion por marca y vehiculo



FIAT



STILO (192)

2.4 20V		10.2001	11.2006	BOSCH	1	57	26/Ø281		X274035	X274036
		10.2001	10.2004	BOSCH	1	38	10		X275017	X275018
		11.2004	11.2006	BOSCH	1	38	10		X275049	X275050

STRADA I (178_)

Tout / All / Alle / Tutti / Todos		06.1999	06.2012	ATE	1	54	20		X224531	X224532
-----------------------------------	--	---------	---------	-----	---	----	----	--	---------	---------

TEMPRA (159)

Tout / All / Alle / Tutti / Todos		03.1990	03.1990	GIRL-TRW	1	48	11		#ID: 792834 792836	X374277	X374278
		03.1990	03.1990	GIRL-TRW	1	48	12		#ID: 791365 791366	X374161	X374162
		03.1990	03.1990	GIRL-TRW	1	48	20		#ID: 792226 792228	X374157	X374158
		03.1990	03.1990	GIRL-TRW	1	54	12		#ID: 791249 791248	X374265	X374266
		03.1990	03.1990	GIRL-TRW	1	54	12		#ID: 795176 795178	X374377	X374378
		03.1990	03.1990	GIRL-TRW	1	54	12			X374469	X374470
		03.1990	03.1990	GIRL-TRW	1	54	20		#ID: 791559 791560	X374267	X374268
		03.1990	08.1996	BENDIX	1	34	11			X255037	X255038
		03.1990	08.1996	GIRL-TRW	1	34	11		#ID: 4753 4754	X375083	X375084
		03.1990	08.1996	GIRL-TRW	1	34	11		#ID: 941 942	X375033	X375034

TIPO (160)

Tout / All / Alle / Tutti / Todos		01.1988	09.1995	GIRL-TRW	1	48	11		#ID: 792834 792836	X374277	X374278
		01.1988	09.1995	GIRL-TRW	1	48	12		#ID: 791365 791366	X374161	X374162
		01.1988	09.1995	GIRL-TRW	1	54	12		#ID: 791249 791248	X374265	X374266
		01.1988	09.1995	GIRL-TRW	1	54	12			X374469	X374470
		01.1988	09.1995	GIRL-TRW	1	54	22			X374165	X374166
		01.1988	02.1993	GIRL-TRW	1	34	11			X375033	X375034
		03.1993	09.1995	GIRL-TRW	1	34	11			X375083	X375084

ULYSSE (179AX)

2.0		08.2002	07.2006	GIRL-TRW	1	60	28/Ø285			X374589	X374590
2.0 D Multijet		05.2006	07.2007	GIRL-TRW	1	60	28/Ø285			X374589	X374590
2.0 JTD		08.2002	08.2006	GIRL-TRW	1	60	28/Ø285			X374589	X374590
2.2 D Multijet		03.2008	03.2010	GIRL-TRW	2	40/45	32/Ø310			X374699	X374700
2.2 JTD		08.2002	08.2006	GIRL-TRW	1	60	28/Ø285			X374589	X374590
		03.2008	03.2010	GIRL-TRW	2	40/45	32/Ø310			X374699	X374700
Tout / All / Alle / Tutti / Todos		08.2002	03.2010	GIRL-TRW	1	38	12			X375291	X375292

ULYSSE (220)

1.8		05.1997	08.2000	BENDIX	1	57	20/Ø257			X254207	X254208
1.9 TD		02.1995	08.2002	GIRL-TRW	1	57	26/Ø281			X374293	X374294
2.0		06.1994	08.2000	GIRL-TRW	1	57	26/Ø281			X374293	X374294
2.0 16V		05.1998	08.2002	GIRL-TRW	1	57	26/Ø281			X374293	X374294
2.0 JTD		10.1999	08.2002	GIRL-TRW	1	57	26/Ø281			X374293	X374294
2.0 JTD 16V		05.1999	08.2002	GIRL-TRW	1	57	26/Ø281			X374293	X374294
2.0 Turbo		06.1994	08.2002	GIRL-TRW	1	57	26/Ø281			X374293	X374294
2.1 TD		03.1996	10.1999	GIRL-TRW	1	57	26/Ø281			X374293	X374294

X=1 : SNRA - X=2 : EAI - X=3 : SERA - X=4 : SEEAC - X=5 : NEOTO - X=6 : STARTCAR

Affectations par Marques

Vehicule application - Zuordnung nach Marke und Fahrzeuge - Applicazione per marca e veicolo - Aplicacion por marca y vehiculo



FIAT



ULYSSE (220)

Tout / All / Alle / Tutti / Todos		06.1994	08.2002	ATE	1	36	10		X225161	X225162
-----------------------------------	--	---------	---------	-----	---	----	----	--	---------	---------

UNO (146_)

Tout / All / Alle / Tutti / Todos		01.1983	01.1989	BENDIX	1	48	10,8		X254085	X254086
		06.1983	10.1995	GIRL-TRW	1	48	12		X374161	X374162
		02.1989	10.1995	BENDIX	1	48	10,8		X254093	X254094
		09.1989	10.1995	GIRL-TRW	1	48	20		X374157	X374158
		01.1983	10.1995	GIRL-TRW	1	30	10,8		X375101	X375102

X 1/9 (128 AS)

Tout / All / Alle / Tutti / Todos		10.1975	12.1998	BENDIX	1	54	10		X254033	X254034
		10.1975	12.1998	BENDIX	1	34	10,8		X255003	X255004



FORD



B-MAX (JK)

Tout / All / Alle / Tutti / Todos		10.2012		GIRL-TRW	1	54	23		X374791	X374792
-----------------------------------	--	---------	--	----------	---	----	----	--	---------	---------

CAPRI (ECJ)

Tout / All / Alle / Tutti / Todos		12.1968	02.1974	GIRL-TRW	2	54	12,7		X374317	X374318
-----------------------------------	--	---------	---------	----------	---	----	------	--	---------	---------

CAPRI II (GECF)

Tout / All / Alle / Tutti / Todos		02.1974	12.1977	ATE	2	54	12,7		X224041	X224042
		02.1974	12.1977	BENDIX	2	54	12,7		X254143	X254144
		02.1974	12.1977	GIRL-TRW	2	54	12,7		X374043	X374044

CAPRI III (GECF)

2.8 i Turbo		01.1982	08.1986	ATE	2	54	20		X224719	X224720
Tout / All / Alle / Tutti / Todos		01.1978	04.1987	GIRL-TRW	2	54	12,7		X374043	X374044

C-MAX I

Tout / All / Alle / Tutti / Todos		02.2007	09.2010	ATE	1	57	25/Ø278 -300		X224601	X224602
		02.2007	09.2010	ATE	1	38	11		X225281	X225282

C-MAX II

Tout / All / Alle / Tutti / Todos		12.2010		ATE	1	57	25/Ø278 -300		X224601	X224602
		12.2010		ATE	1	38	11		X225445	X225446

CONSUL (GGCL/GGFL/GGNL)

Tout / All / Alle / Tutti / Todos		01.1972	12.1975	ATE	2	54	12,7		X224353	X224354
-----------------------------------	--	---------	---------	-----	---	----	------	--	---------	---------

CORSAIR

Tout / All / Alle / Tutti / Todos		10.1963	03.1971	GIRL-TRW	2	54	12,7		X374317	X374318
-----------------------------------	--	---------	---------	----------	---	----	------	--	---------	---------

CORTINA

Tout / All / Alle / Tutti / Todos		10.1970	12.1982	ATE	2	54	12,7		X224041	X224042
		10.1970	12.1982	BENDIX	2	54	12,7		X254143	X254144
		10.1970	12.1982	GIRL-TRW	2	54	12,7		X374043	X374044

Affectations par Marques

Vehicule application - Zuordnung nach Marke und Fahrzeuge - Applicazione per marca e veicolo - Aplicacion por marca y vehiculo



FORD



COUGAR (EC_)

Tout / All / Alle / Tutti / Todos		08.1998	12.2001	ATE	1	60	24		X224269	X224270
		08.1998	12.2001	ATE	1	60	24		X224271	X224272
		08.1998	12.2001	BENDIX	1	36	20		X255039	X255040

COURIER III (F3L, F5L)

Tout / All / Alle / Tutti / Todos		09.1991	02.1996	ATE	1	48	12/Ø239		X224215	X224216
-----------------------------------	--	---------	---------	-----	---	----	---------	--	---------	---------

COURIER IV (J5_, J3_)

1.3		02.1996	02.2000	ATE	1	48	12/Ø239		X224215	X224216
		02.1996		ATE	1	48	20/Ø239,5	ABS	X224571	X224572
		02.1996	02.2000	ATE	1	54	20/Ø239,5		X224477	X224478
		02.1996		ATE	1	54	22/Ø258	ABS	X224573	X224574
1.4 i		04.1996	10.1999	ATE	1	48	12/Ø239		X224215	X224216
		04.1996	10.1999	ATE	1	54	20/Ø239,5		X224477	X224478
1.8 D		02.1996	02.2000	ATE	1	48	12/Ø239		X224215	X224216
		02.1996		ATE	1	48	20/Ø239,5	ABS	X224571	X224572
		02.1996	02.2000	ATE	1	54	20/Ø239,5		X224477	X224478
		02.1996		ATE	1	54	22/Ø258	ABS	X224573	X224574
		06.1999	02.2000	ATE	1	48	12/Ø239		X224215	X224216
		06.1999	02.2002	ATE	1	48	20/Ø239,5	ABS	X224571	X224572
		06.1999	02.2000	ATE	1	54	20/Ø239,5		X224477	X224478
		06.1999	02.2002	ATE	1	54	22/Ø258	ABS	X224573	X224574
1.8 DI		09.2000		ATE	1	48	20/Ø239,5	ABS	X224571	X224572
		09.2000		ATE	1	54	22/Ø258	ABS	X224573	X224574

ECONOVAN (KAA)

1.4		03.1986	03.1992	SUMITOMO	1	60	20,2		X644045	X644046
2.0 D		03.1986	03.1992	SUMITOMO	1	60	20,2		X644045	X644046

ECONOVAN (KBA, KCA)

Tout / All / Alle / Tutti / Todos		03.1986	03.1992	SUMITOMO	1	60	20,2		X644045	X644046
-----------------------------------	--	---------	---------	----------	---	----	------	--	---------	---------

ECOSPORT

1.0 EcoBoost		10.2013		ATE	1	57	25/Ø278 ~300		X224601	X224602
1.5 TDCi		10.2013		ATE	1	57	25/Ø278 ~300		X224601	X224602
1.5 Ti		10.2013		ATE	1	57	25/Ø278 ~300		X224601	X224602

ESCORT I (AFH, ATH)

1.6		08.1969	11.1974	GIRL-TRW	2	54	12,7		X374317	X374318
1100		01.1968	12.1974	ATE	2	48	9,5		X224017	X224018
		01.1968	12.1974	GIRL-TRW	2	48	9,5		X374023	X374024
RS 1600		01.1970	10.1974	GIRL-TRW	2	54	12,7		X374317	X374318

ESCORT II (ATH)

Tout / All / Alle / Tutti / Todos		12.1974	08.1980	ATE	2	54	12,7		X224041	X224042
		12.1974	08.1980	BENDIX	2	54	12,7		X254143	X254144
		12.1974	08.1980	GIRL-TRW	2	54	12,7		X374043	X374044

X=1 : SNRA - X=2 : EAI - X=3 : SERA - X=4 : SEEAC - X=5 : NEOTO - X=6 : STARTCAR

Affectations par Marques

Vehicule application - Zuordnung nach Marke und Fahrzeuge - Applicazione per marca e veicolo - Aplicacion por marca y vehiculo



FORD



ESCORT III (ALD/AWA/GAA/AVA)

1.6 RS Turbo		11.1984	12.1985	ATE	1	60	24		X224175	X224176
Tout / All / Alle / Tutti / Todos		09.1980	07.1986	ATE	1	54	10		X224001	X224002
		09.1980	07.1986	ATE	1	54	24		X224003	X224004
		09.1980	07.1986	BENDIX	1	54	20		X254107	X254108

ESCORT IV (ABFT, ALF, AWF, AVF, GAF)

1.6 Turbo RS		01.1986	07.1990	ATE	1	60	24		X224175	X224176
Tout / All / Alle / Tutti / Todos		10.1985	10.1990	ATE	1	54	10		X224001	X224002
		10.1985	10.1990	ATE	1	54	24		X224003	X224004

ESCORT V (ALL, AVL, GAL)

1.8 16V XR3i (105)		02.1992	09.1992	BENDIX	1	54	20		X254107	X254108
1.8 16V XR3i (130)		02.1992	09.1992	ATE	1	60	24		X224421	X224422
RS 2000		05.1991	09.1992	ATE	1	60	24		X224421	X224422
Tout / All / Alle / Tutti / Todos		07.1990	09.1992	BENDIX	1	54	10		X254103	X254104
		07.1990	09.1992	BENDIX	1	54	20		X254107	X254108
		07.1990	09.1992	ATE	2	33	10		X225115	X225116

ESCORT VI (ALL, GAL)

1.8 16V XR3i		12.1992	01.1995	ATE	1	60	24		X224421	X224422
		12.1992	01.1995	BENDIX	1	54	20		X254107	X254108
		12.1992	01.1995	ATE	2	33	10		X225115	X225116
1.8 i 16V		02.1993	01.1995	ATE	1	60	24		X224421	X224422
		02.1993	01.1995	ATE	2	33	10		X225115	X225116
1.8 XR3i 16V 4x4		08.1993	01.1995	ATE	1	60	24		X224421	X224422
		08.1993	01.1995	BENDIX	1	54	20		X254107	X254108
		08.1993	01.1995	ATE	2	33	10		X225115	X225116
RS 2000 / RS 2000 4x4		09.1992	01.1995	ATE	1	60	24		X224421	X224422
		09.1992	01.1995	ATE	2	33	10		X225115	X225116
RS Cosworth 4x4		09.1992	01.1995	ATE	1	60	24		X224421	X224422
		09.1992	01.1995	GIRL-TRW	1	43	20		X375079	X375080
Tout / All / Alle / Tutti / Todos		09.1992	01.1995	BENDIX	1	54	10		X254103	X254104
		09.1992	01.1995	BENDIX	1	54	20		X254107	X254108
		09.1992	01.1995	ATE	2	33	10		X225115	X225116

ESCORT VII (AAL, ABL, AFL, ALL, ANL, GAL)

1.6 16V 4x4		01.1995	08.1997	ATE	1	60	24		X224421	X224422
		01.1995	08.1997	ATE	2	33	10		X225115	X225116
RS 2000		02.1995	02.1998	ATE	1	60	24		X224421	X224422
		02.1995	02.1998	ATE	2	33	10		X225115	X225116
RS 2000 4x4		02.1995	12.1997	ATE	1	60	24		X224421	X224422
		02.1995	12.1997	ATE	2	33	10		X225115	X225116
RS Cosworth 4x4		02.1995	10.1996	GIRL-TRW	1	43	20		X375079	X375080
Tout / All / Alle / Tutti / Todos		01.1995	08.2000	BENDIX	1	54	20		X254107	X254108
		01.1995	08.2000	ATE	2	33	10		X225115	X225116

X=1 : SNRA - X=2 : EAI - X=3 : SERA - X=4 : SEEAC - X=5 : NEOTO - X=6 : STARTCAR

Affectations par Marques

Vehicule application - Zuordnung nach Marke und Fahrzeuge - Applicazione per marca e veicolo - Aplicacion por marca y vehiculo



FORD



FIESTA I (GFBT, WFVT)

1.6 XR2		08.1981	08.1983	ATE	1	48	10		X224015	X224016
		08.1981	08.1983	ATE	1	54	20		X224171	X224172
		08.1981	08.1983	BENDIX	1	48	10		X254067	X254068
Tout / All / Alle / Tutti / Todos		05.1976	11.1986	ATE	1	48	10		X224015	X224016
		05.1976	11.1986	BENDIX	1	48	10		X254067	X254068

FIESTA II (FBD, FVD)

1.6 XR2		09.1983	11.1989	ATE	1	54	20		X224171	X224172
Tout / All / Alle / Tutti / Todos		09.1983	11.1989	ATE	1	48	10		X224015	X224016

FIESTA II (FVJ)

Tout / All / Alle / Tutti / Todos		03.1989	12.1995	ATE	1	48	12/Ø239		X224215	X224216
-----------------------------------	--	---------	---------	-----	---	----	---------	--	---------	---------

FIESTA III (GFJ)

Tout / All / Alle / Tutti / Todos		03.1989	01.1997	ATE	1	48	12		X224215	X224216
		03.1989	01.1997	ATE	1	54	20		X224477	X224478

FIESTA IV (JA_, JB_)

1.1		09.1995	12.1996	ATE	1	48	12		X224215	X224216
		09.1995	12.1996	ATE	1	54	20		X224477	X224478
1.25 i 16V		08.1995	02.2000	ATE	1	48	12	ABS	X224215	X224216
		08.1995	02.2000	ATE	1	54	20/Ø240	ABS	X224477	X224478
		02.2000	01.2000	ATE	1	48	20	ABS	X224571	X224572
		02.2000	01.2000	ATE	1	54	22/Ø258	ABS	X224573	X224574
1.3 i		08.1995	02.2000	ATE	1	48	12	ABS	X224215	X224216
		08.1995	02.2000	ATE	1	54	20/Ø240	ABS	X224477	X224478
		03.2000	01.2002	ATE	1	48	20	ABS	X224571	X224572
		03.2000	01.2002	ATE	1	54	22/Ø258	ABS	X224573	X224574
1.4 i 16V		04.1996	01.2002	ATE	1	48	12		X224215	X224216
		04.1996	01.2002	ATE	1	54	20		X224477	X224478
1.6 16V Sport		02.2000	01.2002	ATE	1	48	20/Ø240	ABS	X224571	X224572
		02.2000	01.2002	ATE	1	54	22/Ø258	ABS	X224573	X224574
1.8 D		08.1995	01.2000	ATE	1	48	12	ABS	X224215	X224216
		08.1995	01.2000	ATE	1	54	20/Ø240	ABS	X224477	X224478
		02.2000	04.2000	ATE	1	48	20	ABS	X224571	X224572
		02.2000	04.2000	ATE	1	54	22/Ø258	ABS	X224573	X224574
1.8 DI		04.2000	01.2002	ATE	1	48	20/Ø240	ABS	X224571	X224572
		04.2000	01.2002	ATE	1	54	22/Ø258	ABS	X224573	X224574

FIESTA IV (JV_)

D 1.8		05.1998	02.2000	ATE	1	48	12/Ø239	ABS	X224215	X224216
		05.1998	02.2000	ATE	1	54	20/Ø240	ABS	X224477	X224478
		02.2000	04.2002	ATE	1	48	20/Ø240	ABS	X224571	X224572
		02.2000	04.2002	ATE	1	54	22/Ø258	ABS	X224573	X224574
TD 1.8		03.2000	04.2002	ATE	1	48	20/Ø240	ABS	X224571	X224572
		03.2000	04.2002	ATE	1	54	22/Ø258	ABS	X224573	X224574

X=1 : SNRA - X=2 : EAI - X=3 : SERA - X=4 : SEEAC - X=5 : NEOTO - X=6 : STARTCAR

Affectations par Marques

Vehicule application - Zuordnung nach Marke und Fahrzeuge - Applicazione per marca e veicolo - Aplicacion por marca y vehiculo



FORD



FIESTA V (JH_, JD_)

ST150		03.2005	06.2008	ATE	1	54	22/Ø278		X224675	X224676
Tout / All / Alle / Tutti / Todos		11.2001	10.2008	ATE	1	54	20/Ø240		X224571	X224572
		11.2001	10.2008	ATE	1	54	22/Ø258		X224573	X224574
		11.2001	10.2008	GIRL-TRW	1	34	10		X375337	X375338

FIESTA VI

Tout / All / Alle / Tutti / Todos		06.2008		GIRL-TRW	1	54	23/Ø258		X374713	X374714
		06.2008		GIRL-TRW	1	54	23/Ø278		X374791	X374792

FOCUS I (DAW, DBW, DFW, DNW)

ST170		03.2002	11.2004	ATE	1	54	24		X224791	X224792
Tout / All / Alle / Tutti / Todos		10.1998	12.2007	ATE	1	54	22		X224495	X224496
		10.1998	12.2007	GIRL-TRW	1	34	11		X375155	X375156

FOCUS II (DA_)

2.5 RS		01.2009		GIRL-TRW	1	54	28		X374705	X374706
		01.2009		GIRL-TRW	1	38	11		X375361	X375362
2.5 RS 500		01.2009		GIRL-TRW	1	54	28		X374705	X374706
		05.2010		GIRL-TRW	1	38	11		X375361	X375362
2.5 ST		10.2005		ATE	1	57	25		X224683	X224684
		10.2005	01.2008	ATE	1	38	11		X225281	X225282
		10.2005		GIRL-TRW	1	38	11		X375361	X375362
Tout / All / Alle / Tutti / Todos		11.2004	09.2012	ATE	1	57	25		X224601	X224602
		11.2004	09.2012	ATE	1	38	11		X225281	X225282

FOCUS II C-MAX

Tout / All / Alle / Tutti / Todos		10.2003		ATE	1	57	25		X224601	X224602
		10.2003		ATE	1	38	11		X225281	X225282

FOCUS III

1.0 EcoBoost		07.2010		ATE	1	57	25		X224601	X224602
		07.2010		ATE	1	38	11		X225445	X225446
1.5 EcoBoost/TDCi		07.2010		ATE	1	57	25		X224601	X224602
		07.2010		ATE	1	38	11		X225445	X225446
1.6 EcoBoost/Flexifuel/LPG		07.2010		ATE	1	57	25		X224601	X224602
		07.2010		ATE	1	38	11		X225445	X225446
Electric		07.2010		ATE	1	57	25		X224601	X224602
		07.2010		ATE	1	38	11		X225445	X225446

FUSION (JU_)

Tout / All / Alle / Tutti / Todos		08.2002	12.2012	ATE	1	54	22/Ø258		X224573	X224574
-----------------------------------	--	---------	---------	-----	---	----	---------	--	---------	---------

GALAXY I (WGR)

1.9 TDI		03.1995	05.2001	ATE	1	57	25/Ø288		X224449	X224450
		06.2001	05.2006	ATE	1	57	26/Ø300		X224559	X224560
		03.1995	05.2006	GIRL-TRW	1	38	10/Ø226 -232		X375123	X375124
		03.1995	05.2006	GIRL-TRW	1	38	10/Ø226 -232		X375141	X375142

Affectations par Marques

Vehicule application - Zuordnung nach Marke und Fahrzeuge - Applicazione per marca e veicolo - Aplicacion por marca y vehiculo



FORD



GALAXY I (WGR)

2.0 i		11.1995	05.2001	ATE	1	57	25/Ø288		X224449	X224450
		06.2001	05.2006	ATE	1	57	26/Ø300		X224559	X224560
		11.1995	05.2006	GIRL-TRW	1	38	10/Ø226 ~232		X375123	X375124
		11.1995	05.2006	GIRL-TRW	1	38	10/Ø226 ~232		X375141	X375142
2.3 16V		01.1997	05.2001	ATE	1	57	25/Ø288		X224449	X224450
		06.2001	05.2006	ATE	1	57	26/Ø300		X224559	X224560
		01.1997	05.2006	GIRL-TRW	1	38	10/Ø226 ~232		X375141	X375142
		01.1997	10.2002	GIRL-TRW	1	38	10/Ø226 ~232		X375123	X375124
2.8 i V6		11.1995	04.2000	ATE	1	57	25/Ø288		X224449	X224450
		11.1995	04.2000	GIRL-TRW	1	38	10/Ø226 ~232		X375123	X375124
		11.1995	04.2000	GIRL-TRW	1	38	10/Ø226 ~232		X375141	X375142
2.8 i V6 4x4		04.1996	04.2000	ATE	1	57	25/Ø288		X224449	X224450
		04.1996	04.2000	GIRL-TRW	1	38	10/Ø226 ~232		X375123	X375124
		04.1996	04.2000	GIRL-TRW	1	38	10/Ø226 ~232		X375141	X375142
2.8 V6		04.2000	05.2006	GIRL-TRW	1	38	13,5/Ø294		X375153	X375154

GALAXY II (WA6)

2.0 EcoBoost		03.2010	01.2011	ATE	1	60	28/Ø316		X224713	X224714
		02.2011	06.2015	ATE	1	60	28/Ø300		X224663	X224664
		03.2010		GIRL-TRW	1	38	11		X375361	X375362
		03.2010		GIRL-TRW	1	38	11		X377041	X377042
2.2 TDCi		03.2008	09.2008	ATE	1	60	28/Ø316		X224713	X224714
		10.2008	06.2015	ATE	1	60	28/Ø300		X224663	X224664
		03.2008		GIRL-TRW	1	38	11		X375361	X375362
		03.2008		GIRL-TRW	1	38	11		X377041	X377042
Tout / All / Alle / Tutti / Todos		05.2006	06.2015	ATE	1	60	28/Ø300		X224663	X224664
		05.2006		GIRL-TRW	1	38	11		X375361	X375362
		05.2006		GIRL-TRW	1	38	11		X377041	X377042

GRANADA I (GG_)

Tout / All / Alle / Tutti / Todos		01.1972	08.1977	ATE	2	54	12,7		X224041	X224042
		01.1972	08.1977	ATE	2	54	12,7		X224353	X224354
		01.1972	08.1977	GIRL-TRW	2	54	12,7		X374043	X374044
		01.1972	08.1977	GIRL-TRW	2	54	24		X374065	X374066

GRANADA II (GU/GNU)

Tout / All / Alle / Tutti / Todos		08.1977	08.1985	GIRL-TRW	2	54	12,7		X374043	X374044
		08.1977	08.1985	GIRL-TRW	2	54	24		X374123	X374124
		08.1982	08.1985	ATE	1	60	24		X224175	X224176
		08.1982	08.1985	ATE	2	54	12,5		X224041	X224042
		08.1977	08.1985	GIRL-TRW	1	43	10,5		X375011	X375012

GRANADA III (GGE)

Tout / All / Alle / Tutti / Todos		03.1990	08.1992	ATE	1	60	24		X224175	X224176
		03.1990	08.1992	GIRL-TRW	1	43	10		X375067	X375068

X=1 : SNRA - X=2 : EAI - X=3 : SERA - X=4 : SEEAC - X=5 : NEOTO - X=6 : STARTCAR

Affectations par Marques

Vehicule application - Zuordnung nach Marke und Fahrzeuge - Applicazione per marca e veicolo - Aplicacion por marca y vehiculo



FORD



GRAND C-MAX

Tout / All / Alle / Tutti / Todos		12.2010		ATE	1	57	25		X224601	X224602
		12.2010		ATE	1	38	11		X225445	X225446

KA I (RB_)

Tout / All / Alle / Tutti / Todos		09.1996	11.2008	ATE	1	48	12/Ø239		X224215	X224216
		09.1996	11.2008	ATE	1	48	20/Ø240		X224571	X224572
		09.1996	11.2008	ATE	1	54	22/Ø258		X224573	X224574

KA II (RU8)

1.2		10.2008		BOSCH	1	48	11/Ø240		X274113	X274114
1.3 TDCi		10.2008		BOSCH	1	48	20		X274083	X274084

KUGA I

Tout / All / Alle / Tutti / Todos		03.2008	11.2012	ATE	1	57	25		X224601	X224602
		03.2008	11.2012	GIRL-TRW	1	38	11		X375361	X375362

KUGA II

Tout / All / Alle / Tutti / Todos		03.2013		ATE	1	57	25		X224601	X224602
		03.2013		ATE	1	38	11		X225445	X225446

MAVERICK I

Tout / All / Alle / Tutti / Todos		02.1993	04.1998	GIRL-TRW	2	43	26		X374393	X374394
		02.1993	04.1998	AKE	1	43	18		X165105	X165106

MAVERICK II

Tout / All / Alle / Tutti / Todos		02.2001		ATE	1	60	24/Ø278		X224793	X224794
		02.2001		ATE	1	66	26/Ø303		X224743	X224744
		02.2001		ATE	1	40	11		X225371	X225372

MONDEO I - II (BAP, BNP, BFP, GBP)

Tout / All / Alle / Tutti / Todos		01.1993	11.2000	ATE	1	60	24/Ø260		X224269	X224270
		01.1993	11.2000	ATE	1	60	24/Ø260		X224271	X224272
		01.1993	11.2000	ATE	1	60	24/Ø278		X224423	X224424
		01.1993	11.2000	BENDIX	1	36	20		X255039	X255040

MONDEO I - II (BNP) Clipper/Rural/Turnier

Tout / All / Alle / Tutti / Todos		01.1993	11.2000	ATE	1	60	24/Ø260		X224269	X224270
		01.1993	11.2000	ATE	1	60	24/Ø260		X224271	X224272
		01.1993	11.2000	ATE	1	60	24/Ø278		X224423	X224424
		09.1996	11.2000	BENDIX	1	36	20		X255067	X255068

MONDEO III (B4Y, B5Y)

Tout / All / Alle / Tutti / Todos		11.2000	08.2007	BOSCH	1	57	24		X274045	X274046
		11.2000	09.2004	BOSCH	1	38	12	#ID: 0204YO113_	X275015	X275016
		10.2004	08.2007	BOSCH	1	38	12	#ID: 0204Y0168_A	X275031	X275032

MONDEO III (BWY) Clipper

Tout / All / Alle / Tutti / Todos		11.2000	08.2007	BOSCH	1	57	24		X274045	X274046
		11.2000	09.2004	BOSCH	1	38	12	#ID: 0204YO113_	X275019	X275020
		10.2004	08.2007	BOSCH	1	38	12	#ID: 0204Y0168_A	X275033	X275034

X=1 : SNRA - X=2 : EAI - X=3 : SERA - X=4 : SEEAC - X=5 : NEOTO - X=6 : STARTCAR

Affectations par Marques

Vehicule application - Zuordnung nach Marke und Fahrzeuge - Applicazione per marca e veicolo - Aplicacion por marca y vehiculo



FORD



MONDEO IV (BA7)

2.2 TDCi		03.2007	01.2015	ATE	1	60	28/Ø300		X224663	X224664
		03.2007	01.2015	ATE	1	60	28/Ø316		X224713	X224714
Tout / All / Alle / Tutti / Todos		03.2007	01.2015	ATE	1	60	28/Ø300		X224663	X224664
		03.2007	01.2015	GIRL-TRW	1	38	11		X375361	X375362

ORION I (AFD)

Tout / All / Alle / Tutti / Todos		07.1983	03.1986	ATE	1	54	10		X224001	X224002
		07.1983	03.1986	ATE	1	54	24		X224003	X224004

ORION II (AFF)

Tout / All / Alle / Tutti / Todos		12.1985	08.1990	ATE	1	54	10		X224001	X224002
		12.1985	08.1990	ATE	1	54	24		X224003	X224004

ORION III (GAL)

1.8 i 16V		07.1990	12.1993	ATE	1	60	24		X224421	X224422
		07.1990	12.1993	BENDIX	1	54	20		X254107	X254108
Tout / All / Alle / Tutti / Todos		07.1990	12.1993	BENDIX	1	54	10		X254103	X254104
		07.1990	12.1993	BENDIX	1	54	20		X254107	X254108
		01.1992	12.1993	ATE	2	33	10		X225115	X225116

P 100 I

1.6		04.1982	09.1987	GIRL-TRW	2	54	12,7		X374309	X374310
-----	--	---------	---------	----------	---	----	------	--	---------	---------

P 100 II

Tout / All / Alle / Tutti / Todos		10.1987	12.1992	ATE	1	54	24		X224003	X224004
-----------------------------------	--	---------	---------	-----	---	----	----	--	---------	---------

PUMA (EC_)

Tout / All / Alle / Tutti / Todos		03.1997	02.2000	ATE	1	54	20/Ø239,5		X224477	X224478
		03.2000	06.2002	ATE	1	54	22/Ø258		X224573	X224574

RANGER I (ER, EQ)

Tout / All / Alle / Tutti / Todos		10.1999	06.2006	PBR	1	60	24		X594003	X594004
		10.1999	06.2006	TOKICO	2	43	26		X674079	X674080

RANGER II (ES, ET)

Tout / All / Alle / Tutti / Todos		05.2006	07.2012	TOKICO	2	43	26		X674079	X674080
-----------------------------------	--	---------	---------	--------	---	----	----	--	---------	---------

RANGER III (TKE)

2.2 TDCi		04.2011		GIRL-TRW	2	42	32		X374787	X374788
2.2 TDCi 4x4		04.2011		GIRL-TRW	2	42	32		X374787	X374788
3.2 TDCi 4x4		04.2011		GIRL-TRW	2	42	32		X374787	X374788

SCORPIO I (GAE, GGE)

Tout / All / Alle / Tutti / Todos		04.1985	12.1994	ATE	1	60	24		X224175	X224176
		04.1985	12.1994	ATE	1	60	24		X224267	X224268
		04.1985	09.1994	GIRL-TRW	1	43	10		X375067	X375068
		04.1985	09.1994	GIRL-TRW	1	43	10,5		X375011	X375012
		04.1985	09.1994	GIRL-TRW	1	43	20		X375079	X375080

Affectations par Marques

Vehicule application - Zuordnung nach Marke und Fahrzeuge - Applicazione per marca e veicolo - Aplicacion por marca y vehiculo



FORD



SCORPIO II (GFR, GGR)

2.9 i		10.1994	08.1998	ATE	1	60	24/Ø278		X224423	X224424
		10.1994	06.1996	GIRL-TRW	1	43	20		X375079	X375080

SCORPIO II (GFR, GGR, GNR)

Tout / All / Alle / Tutti / Todos		10.1994	08.1998	ATE	1	60	24/Ø260		X224269	X224270
		10.1994	08.1998	ATE	1	60	24/Ø260		X224271	X224272
		10.1994	08.1998	GIRL-TRW	1	43	10		X375067	X375068
		10.1994	08.1998	GIRL-TRW	1	43	20		X375079	X375080

SCORPIO II (GNR, GGR)

2.9 i		02.1995	06.1996	ATE	1	60	24/Ø278		X224423	X224424
2.9 i 24V		10.1994	08.1998	ATE	1	60	24/Ø278		X224423	X224424

SIERRA (BNC, BNG)

Tout / All / Alle / Tutti / Todos		08.1982	02.1993	ATE	1	54	24/Ø240		X224003	X224004
		08.1982	02.1993	ATE	1	54	24/Ø240		X224004	X224003
		08.1982	02.1993	ATE	1	60	24/Ø260		X224175	X224176
		08.1982	02.1993	GIRL-TRW	1	54	13/Ø239		X374119	X374120
		08.1982	12.1986	GIRL-TRW	1	43	10,5		X375067	X375068

SIERRA (GBC, GBG, GB4)

Tout / All / Alle / Tutti / Todos		12.1991	02.1993	ATE	1	54	24/Ø240		X224003	X224004
		12.1991	02.1993	ATE	1	54	24/Ø240		X224004	X224003
		12.1991	02.1993	ATE	1	60	24/Ø260		X224175	X224176
		12.1991	02.1993	GIRL-TRW	1	54	13/Ø239		X374119	X374120
		12.1991	02.1993	GIRL-TRW	1	43	10		X375067	X375068

SIERRA (GBC, GBG, GB4) Cosworth

2.0 16V Cosworth 4x4		01.1990	02.1993	ATE	1	60	24		X224267	X224268
		01.1990	02.1993	GIRL-TRW	1	43	20		X375079	X375080
2.0 16V Cosworth 4x4 CAT		01.1990	02.1993	ATE	1	60	24		X224267	X224268
		01.1990	02.1993	GIRL-TRW	1	43	20		X375079	X375080
2.0 RS Cosworth		01.1987	12.1990	ATE	4	40	24		X224105	X224106
		11.1987	01.1990	GIRL-TRW	1	43	10		X375067	X375068

S-MAX I (WA6)

1.6 EcoBoost		02.2011	12.2014	ATE	1	60	28/Ø300		X224663	X224664
1.6 TDCi		02.2011	12.2014	ATE	1	60	28/Ø300		X224663	X224664
1.8 TDCi		05.2006	12.2014	ATE	1	60	28/Ø300		X224663	X224664
		05.2006	12.2014	GIRL-TRW	1	38	11		X375361	X375362
		05.2006	12.2014	GIRL-TRW	1	38	11		X375371	X375372
		05.2006	12.2014	GIRL-TRW	1	38	11		X377041	X377042
2.0		05.2006	12.2014	ATE	1	60	28/Ø300		X224663	X224664
2.0 EcoBoost		03.2010	05.2011	ATE	1	60	28/Ø316		X224713	X224714
		06.2011	12.2014	ATE	1	60	28/Ø300		X224663	X224664
2.0 Flexifuel		05.2006	12.2014	ATE	1	60	28/Ø300		X224663	X224664
2.0 TDCi		05.2006	12.2014	ATE	1	60	28/Ø300		X224663	X224664

X=1 : SNRA - X=2 : EAI - X=3 : SERA - X=4 : SEEAC - X=5 : NEOTO - X=6 : STARTCAR

Affectations par Marques

Vehicule application - Zuordnung nach Marke und Fahrzeuge - Applicazione per marca e veicolo - Aplicacion por marca y vehiculo



FORD



S-MAX I (WA6)

2.2 TDCi		03.2008	02.2011	ATE	1	60	28/Ø316		X224713	X224714
		03.2011	12.2014	ATE	1	60	28/Ø300		X224663	X224664
2.3		07.2007	12.2014	ATE	1	60	28/Ø300		X224663	X224664
2.5 ST		05.2006	12.2014	ATE	1	60	28/Ø316		X224713	X224714
Tout / All / Alle / Tutti / Todos		05.2006	12.2014	GIRL-TRW	1	38	11		X375361	X375362
		05.2006	12.2014	GIRL-TRW	1	38	11		X377041	X377042

STREET KA (RL2)

1.6		05.2003	07.2005	ATE	1	54	22/Ø258		X224573	X224574
-----	--	---------	---------	-----	---	----	---------	--	---------	---------

TAUNUS

Tout / All / Alle / Tutti / Todos		12.1951	08.1985	ATE	2	48	10,5		X224325	X224326
		12.1951	08.1985	ATE	2	48	12,7		X224383	X224384
		12.1951	08.1985	ATE	2	54	12,7		X224041	X224042
		12.1951	08.1985	BENDIX	2	54	12,7		X254143	X254144
		12.1951	08.1985	GIRL-TRW	2	54	12,7		Cortina X374309	X374310
		12.1951	08.1985	GIRL-TRW	2	54	12,7		Taurus X374043	X374044

TOURNEO I

Tout / All / Alle / Tutti / Todos		06.2002	12.2013	ATE	1	54	24		X224605	X224606
		06.2002	12.2013	ATE	1	36	11		X225301	X225302

TOURNEO II

2.2 TDCi		04.2012		BOSCH	2	48	33/Ø289		X274125	X274126
		04.2012		BOSCH	1	48	16/Ø308		X275083	X275084
Tout / All / Alle / Tutti / Todos		04.2012		ATE	1	57	25/Ø300		X224601	X224602
		04.2012		ATE	1	38	11/Ø265		X225445	X225446

TRANSIT I

100-115		09.1976	11.1985	LOCK	4	41	14,3		X464011	X464012
130-150-190		09.1976	11.1985	LOCK	4	41	24		X464013	X464014
150. 160.		09.1976	11.1985	LOCK	2	57	14,3	3150->	X464019	X464020
		09.1976	11.1985	LOCK	4	41	14,3	->3150	X464015	X464016
75 - 115 VANS		01.1973	08.1976	LOCK	2	57	14,3		X464017	X464018
80-100-115-125-130		09.1976	12.1986	LOCK	2	57	14,3	->2835	X464019	X464020

TRANSIT II

130 - 160 KOMBI		11.1985	07.1991	LOCK	4	41	14,3		X464021	X464022
130-150-160-175-190 Heavy Duty		01.1989	07.1991	LOCK	4	46	14,3		X464101	X464102
100L		01.1986	08.1991	LOCK	2	57	14,3		X464067	X464068
130		11.1985	07.1991	LOCK	2	57	14,3		X464067	X464068
130. 150. 190		08.1991	12.1999	BENDIX	2	42	24		X254139	X254140
160 - 190 Van - Kombi CAB		11.1985	07.1991	LOCK	4	41	14,3		X464021	X464022
2.5		01.1996	12.1999	BENDIX	2	45			X254239	X254240
80 - 100 - 120 DIESEL		11.1985	09.1988	BENDIX	2	42	14,3		X254211	X254212
		10.1988	07.1991	BENDIX	2	42	14,3		X254055	X254056

X=1 : SNRA - X=2 : EAI - X=3 : SERA - X=4 : SEEAC - X=5 : NEOTO - X=6 : STARTCAR

Affectations par Marques

Vehicule application - Zuordnung nach Marke und Fahrzeuge - Applicazione per marca e veicolo - Aplicacion por marca y vehiculo



FORD



TRANSIT II

80 - 100 - 120 ESS-GASOLINE-BENZINA		11.1985	09.1988	BENDIX	2	38	14,3		X254209	X254210
		10.1988	07.1991	BENDIX	2	38	14,3		X254053	X254054
80. 100. 115. 120		08.1991	12.1999	BENDIX	2	42	24		X254137	X254138

TRANSIT III

Tout / All / Alle / Tutti / Todos		01.2000	07.2006	BOSCH	2	48	24,5		X274047	X274048
-----------------------------------	--	---------	---------	-------	---	----	------	--	---------	---------

TRANSIT IV

Tout / All / Alle / Tutti / Todos		04.2006	07.2013	BOSCH	2	48	28/Ø280		X274085	X274086
		04.2006	07.2013	BOSCH	2	48	28/Ø300		X274089	X274090
		04.2006	07.2013	BOSCH	1	48	16		X275053	X275054
		04.2006	07.2013	BREMBO	1	52	16		X285103	X285104

TRANSIT V

Tout / All / Alle / Tutti / Todos		08.2013		BOSCH	2	48	31-33/Ø310-308		X274127	X274128
		08.2013		BOSCH	2	48	33/Ø289		X274125	X274126
		08.2013		BOSCH	1	48	16/Ø289		X275085	X275086
		08.2013		BOSCH	1	48	16/Ø308		X275083	X275084
		08.2013		BOSCH	1	54	16/Ø308		X275087	X275088

TRANSIT-CONNECT

Tout / All / Alle / Tutti / Todos		09.2002	12.2013	ATE	1	54	24		X224605	X224606
		05.2015		ATE	1	57	25		X224601	X224602
		09.2002	12.2013	ATE	1	36	11		X225301	X225302
		05.2015		ATE	1	38	11		X225445	X225446

TRANSIT-TOURNEO

Tout / All / Alle / Tutti / Todos		11.1994	12.2000	BENDIX	2	42	24		X254137	X254138
		11.1994	12.2000	BENDIX	2	42	24		X254139	X254140
		07.2006	08.2014	BOSCH	2	48	28/Ø280		X274085	X274086
		07.2006	08.2014	BOSCH	2	48	28/Ø300		X274089	X274090
		07.2006	08.2014	BOSCH	-	48	16		X275053	X275054

ZEPHYR IV

Tout / All / Alle / Tutti / Todos		03.1968	10.1972	GIRL-TRW	2	48	9,6		X374303	X374304
-----------------------------------	--	---------	---------	----------	---	----	-----	--	---------	---------



FSO



POLONEZ I

Tout / All / Alle / Tutti / Todos		10.1977	12.1991	BENDIX	1	48	10,8		X254199	X254200
		10.1977	12.1991	BENDIX	1	38	10,8		X255035	X255036

POLONEZ II

Tout / All / Alle / Tutti / Todos		08.1988	08.1992	BENDIX	1	48	10,8		X254199	X254200
		08.1988	08.1992	BENDIX	1	38	10,8		X255035	X255036

POLONEZ III

Tout / All / Alle / Tutti / Todos		09.1992	03.2002	BENDIX	1	48	10,8		X254199	X254200
		09.1992	03.2002	BENDIX	1	38	10,8		X255035	X255036

X=1 : SNRA - X=2 : EAI - X=3 : SERA - X=4 : SEEAC - X=5 : NEOTO - X=6 : STARTCAR

Affectations par Marques

Vehicule application - Zuordnung nach Marke und Fahrzeuge - Applicazione per marca e veicolo - Aplicacion por marca y vehiculo



GMC

GMC

GMC

K1500

K1500	2"15/16		01.1992	12.1997	K/H	1	74,6			X794107	X794108
-------	---------	--	---------	---------	-----	---	------	--	--	---------	---------

SIERRA

Tout / All / Alle / Tutti / Todos		01.1999		PBR	1	54				X595005	X595006
-----------------------------------	--	---------	--	-----	---	----	--	--	--	---------	---------

YUKON 4WD

Tout / All / Alle / Tutti / Todos		01.2000	12.2002	PBR	1	54				X595005	X595006
-----------------------------------	--	---------	---------	-----	---	----	--	--	--	---------	---------



HONDA



ACCORD I (SJ, SY)

Tout / All / Alle / Tutti / Todos		01.1976	12.1984	AKE	1	51	12		Model: SJ	X164035	X164036
		01.1976	12.1984	AKE	1	51	12		Model: SJ	X164049	X164050
		01.1976	12.1984	AKE	1	51	17		Model: USA	X164193	X164194
		01.1976	12.1984	TOKICO	1	51	17		Model: SY	X674001	X674002

ACCORD II (AC, AD)

Tout / All / Alle / Tutti / Todos		09.1983	10.1985	TOKICO	1	51	19			X674053	X674054
-----------------------------------	--	---------	---------	--------	---	----	----	--	--	---------	---------

ACCORD III (CA, CA4, CA5)

Tout / All / Alle / Tutti / Todos		11.1985	12.1989	TOKICO	1	51	19			X674053	X674054
		11.1985	12.1989	NISSIN	1	30	10			X585001	X585002

ACCORD IV (CB, CC)

1.8		01.1990	12.1991	AKE	1	57	23/Ø260			X164205	X164206
2.0 16V (CB3)		01.1990	03.1993	AKE	1	57	23/Ø260			X164205	X164206
		01.1990	03.1993	NISSIN	1	57	23/Ø281			X584037	X584038
2.0 i 16V (CB3)		01.1990	03.1993	NISSIN	1	34	10			X585021	X585022
		01.1990	03.1993	NISSIN	1	34	10			X585021	X585022
2.0 i 16V (CC9)		03.1993	12.1993	NISSIN	1	57	25			X584009	X584010
		03.1993	12.1993	NISSIN	1	38	10			X585025	X585026
2.2 (CB3, CB7)		10.1991	10.1993	AKE	1	57	23/Ø260			X164205	X164206
		10.1991	10.1993	NISSIN	1	57	23/Ø281			X584037	X584038
		10.1991	10.1993	NISSIN	1	34	10			X585021	X585022
		10.1991	10.1993	NISSIN	1	34	10			X585023	X585024
2.2 (CB8, CB9)		01.1992	12.1993	AKE	1	57	23			X164205	X164206
		05.1992	10.1993	NISSIN	1	34	10			X585023	X585024
2.2 EX/EXRL 16V		01.1990	12.1993	AKE	1	57	23			X164205	X164206
		01.1990	12.1993	NISSIN		34	10			X585021	X585022
2.2 i 16V (CB7)		01.1990	03.1993	AKE	1	57	23			X164205	X164206
		01.1990	03.1993	NISSIN	1	34	10			X585023	X585024
2.2 i 16V (CB8)		01.1991	12.1993	NISSIN	1	57	25			X584009	X584010
		01.1991	12.1991	NISSIN	1	34	10			X585021	X585022
		01.1991	12.1993	NISSIN	1	38	10			X585025	X585026
2.2 i 16V Automatik (CB7)		01.1990	03.1993	AKE	1	57	23			X164205	X164206
		01.1990	03.1993	NISSIN	1	34	10			X585023	X585024

X=1 : SNRA - X=2 : EAI - X=3 : SERA - X=4 : SEEAC - X=5 : NEOTO - X=6 : STARTCAR

Affectations par Marques

Vehicule application - Zuordnung nach Marke und Fahrzeuge - Applicazione per marca e veicolo - Aplicacion por marca y vehiculo

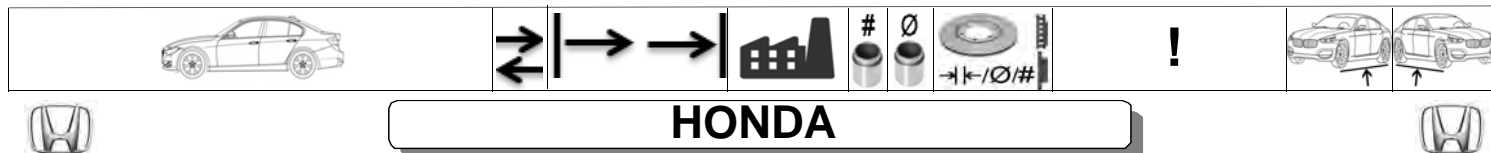

HONDA

ACCORD IV (CB, CC)

2.2 LX (CB8, CB9)		04.1991	02.1994	AKE	1	57	23		X164205	X164206
		04.1991	02.1994	NISSIN	1	34	10		X585023	X585024

ACCORD V (CC, CD)

Tout / All / Alle / Tutti / Todos		03.1993	01.1996	GIRL-TRW	1	57	23		X374371	X374372
		03.1993	01.1996	GIRL-TRW	1	57	23		X374373	X374374
		03.1993	01.1996	NISSIN	1	57	23		X584033	X584034
		03.1993	01.1996	GIRL-TRW	1	34	10		X375095	X375096

ACCORD V (CD7, CD9) COUPE

Tout / All / Alle / Tutti / Todos		09.1993	02.1998	AKE	1	57	23		X164205	X164206
		09.1993	02.1998	NISSIN	1	57	25		X584009	X584010
		09.1993	02.1998	NISSIN	1	34	10		X585021	X585022

ACCORD V (CE)

Tout / All / Alle / Tutti / Todos		09.1993	10.1998	GIRL-TRW	1	57	23		X374371	X374372
		09.1993	10.1998	NISSIN	1	57	23		X584033	X584034
		09.1993	10.1998	NISSIN	1	57	25		X584009	X584010
		09.1993	10.1998	GIRL-TRW	1	34	10		X375095	X375096

ACCORD V (CF)

Tout / All / Alle / Tutti / Todos		04.1996	10.1998	GIRL-TRW	1	57	23		X374371	X374372
		04.1996	10.1998	NISSIN	1	57	23		X584033	X584034
		04.1996	10.1998	GIRL-TRW	1	34	10		X375095	X375096

ACCORD VI (CG, CH, CK)

1.6/1.6 i/1.6 LS		10.1998	06.2003	GIRL-TRW	1	57	23		X374621	X374622
2.0 i 16V		02.1998	06.2003	NISSIN	2	^{38/42}	25		X584045	X584046
		02.1998	06.2003	NISSIN	1	34	10		X585031	X585032
2.2 Type-R		02.1999	12.2002	NISSIN	2	^{38/42}	25		X584045	X584046
3.0 V6 24V		02.1998	06.2003	NISSIN	2	^{38/42}	25		X584045	X584046
		02.1998	06.2003	AKE	1	34	10		X165143	X165144
Tout / All / Alle / Tutti / Todos		02.1998	06.2003	GIRL-TRW	1	57	25		X374623	X374624
		02.1998	06.2003	GIRL-TRW	1	38	10		X375215	X375216

ACCORD VII (CL, CN)

Tout / All / Alle / Tutti / Todos		02.2003	09.2012	ATE	1	57	25		X224701	X224702
		02.2003	09.2012	GIRL-TRW	1	38	10		X375215	X375216

ACCORD VII (CM)

Tout / All / Alle / Tutti / Todos		04.2003	05.2008	ATE	1	57	25		X224701	X224702
		04.2003	05.2008	NISSIN	1	38	9		X585015	X585016
		01.2004	05.2008	GIRL-TRW	1	38	10		X375215	X375216

ACCORD VIII (CU, CW)

2.0 i (CU1)		07.2008	06.2015	NISSIN	1	38	9		X585051	X585052
-------------	--	---------	---------	--------	---	----	---	--	---------	---------

Affectations par Marques

Vehicule application - Zuordnung nach Marke und Fahrzeuge - Applicazione per marca e veicolo - Aplicacion por marca y vehiculo



HONDA



ACCORD VIII (CU, CW)

Tout / All / Alle / Tutti / Todos		07.2008	06.2015	AKE	2	38/43	25		X164311	X164312
		07.2008	06.2015	ATE	1	57	25		X224797	X224798
		07.2008	06.2015	NISSIN	1	38	9	Auto.	X585047	X585048
		07.2008	06.2015	NISSIN	1	38	9	Manu.	X585049	X585050

CIVIC I (AN) 2WD

1.5		10.1983	12..1988	SUMITOMO	1	51	12		X644041	X644042
-----	--	---------	----------	----------	---	----	----	--	---------	---------

CIVIC I (AR) 4WD

1.5		10.1983	12..1988	TOKICO	1	51	17		X674001	X674002
-----	--	---------	----------	--------	---	----	----	--	---------	---------

CIVIC II (EE)

Tout / All / Alle / Tutti / Todos		01.1988	12.1992	AKE	1	51	19		X164081	X164082
		01.1988	12.1992	NISSIN	1	54	19		X584003	X584004

CIVIC IV (EC, ED, EE)

1.2		01.1988	12.1991	NISSIN	1	51	12		X584011	X584012
1.3 (EC8)		10.1987	09.1991	NISSIN	1	51	12		X584011	X584012
1.4 L (EC9)		10.1987	12.1989	NISSIN	1	51	17		X584035	X584036
		10.1987	12.1989	NISSIN	1	54	19		X584003	X584004
1.4 L (ED2)		10.1987	12.1989	NISSIN	1	51	17		X584035	X584036
		01.1988	09.1991	AKE	1	51	19		X164081	X164082
1.5		01.1988	09.1991	NISSIN	1	54	19		X584003	X584004
		09.1987	12.1991	NISSIN	1	51	17		X584035	X584036
1.6		09.1987	12.1991	NISSIN	1	54	19		X584003	X584004
		09.1987	12.1991	NISSIN	1	57	21		X584005	X584006
Tout / All / Alle / Tutti / Todos		09.1987	12.1991	NISSIN	1	30	10		X585003	X585004

CIVIC IX (FK)

Tout / All / Alle / Tutti / Todos		02.2012		ATE	1	57	25		X224837	X224838
		02.2012		GIRL-TRW	1	54	23		X374755	X374756
		02.2012		ATE	1	34	9		X225409	X225410

CIVIC V (EG, EH)

1.3		10.1991	12.1995	NISSIN	1	51	17/Ø231		X584021	X584022
1.5		10.1991	12.1995	NISSIN	1	51	21/Ø242		X584023	X584024
1.6		10.1991	12.1995	NISSIN	1	51	21/Ø242		X584023	X584024
		10.1991	12.1995	NISSIN	1	54	21/Ø262		X584025	X584026
Tout / All / Alle / Tutti / Todos		10.1991	12.1995	NISSIN	1	30	9		X585019	X585020

CIVIC V (EJ) COUPE

Tout / All / Alle / Tutti / Todos		08.1993	03.1996	NISSIN	1	51	21/Ø242		X584023	X584024
		08.1993	03.1996	NISSIN	1	54	21/Ø262		X584025	X584026
		08.1993	03.1996	NISSIN	1	30	9		X585019	X585020

CIVIC VI (EJ, EK)

1.4		11.1995	02.2001	GIRL-TRW	1	54	21		X374167	X374168
		11.1995	02.2001	NISSIN	1	54	21		X584025	X584026

X=1 : SNRA - X=2 : EAI - X=3 : SERA - X=4 : SEEAC - X=5 : NEOTO - X=6 : STARTCAR

Affectations par Marques

Vehicule application - Zuordnung nach Marke und Fahrzeuge - Applicazione per marca e veicolo - Aplicacion por marca y vehiculo



HONDA



CIVIC VI (EJ, EK)

1.5		11.1995	02.2001	GIRL-TRW	1	54	21		X374167	X374168
		11.1995	02.2001	NISSIN	1	51	21/Ø242		X584023	X584024
		11.1995	09.2000	NISSIN	1	54	21/Ø262		X584025	X584026
1.6		10.1995	02.2001	GIRL-TRW	1	54	21		X374167	X374168
		10.1995	02.2001	GIRL-TRW	1	57	23		X374371	X374372
		10.1995	02.2001	NISSIN	1	54	21		X584025	X584026
1.7		11.1995	02.2001	NISSIN	1	54	21		X584025	X584026
2.0 TDiC		11.1998	10.2000	GIRL-TRW	1	54	21		X374167	X374168
Tout / All / Alle / Tutti / Todos		10.1995	02.2001	GIRL-TRW	1	30	10	#ID: 6732122_	X375081	X375082
		10.1995	02.2001	GIRL-TRW	1	34	10	#ID: 2243 2244	X375409	X375410

CIVIC VI (EM1) COUPE

Tout / All / Alle / Tutti / Todos		03.1996	12.2000	NISSIN	1	54	21/Ø262		X584025	X584026
-----------------------------------	--	---------	---------	--------	---	----	---------	--	---------	---------

CIVIC VI (MA, MB, MC)

1.4		09.1994	02.2001	GIRL-TRW	1	54	21		X374167	X374168
		09.1994	02.2001	NISSIN	1	54	21		X584025	X584026
		09.1994	02.2001	GIRL-TRW	1	30	10		X375081	X375082
		09.1994	02.2001	GIRL-TRW	1	34	10		X375409	X375410
1.5		09.1994	02.2001	GIRL-TRW	1	54	21		X374167	X374168
		09.1994	02.2001	NISSIN	1	54	21		X584025	X584026
		09.1994	02.2001	GIRL-TRW	1	30	10		X375081	X375082
		09.1994	02.2001	GIRL-TRW	1	34	10		X375409	X375410
1.6		09.1994	02.2001	GIRL-TRW	1	54	21		X374167	X374168
		09.1994	02.2001	GIRL-TRW	1	57	23		X374371	X374372
		09.1994	02.2001	NISSIN	1	54	21		X584025	X584026
		09.1994	02.2001	GIRL-TRW	1	30	10		X375081	X375082
		09.1994	02.2001	GIRL-TRW	1	34	10		X375409	X375410
1.8		01.1997	02.2001	GIRL-TRW	1	57	23		X374371	X374372
		01.1997	02.2001	GIRL-TRW	1	34	10		X375409	X375410
2.0		01.1997	02.2001	GIRL-TRW	1	54	21		X374167	X374168
		01.1997	02.2001	GIRL-TRW	1	57	23		X374371	X374372
		01.1997	02.2001	GIRL-TRW	1	30	10		X375081	X375082
		01.1997	02.2001	GIRL-TRW	1	34	10		X375409	X375410

CIVIC VII (EM2) COUPE

Tout / All / Alle / Tutti / Todos		05.2001	12.2005	NISSIN	1	54	21		X584061	X584062
		05.2001	12.2005	NISSIN	1	34	10		X585035	X585036

CIVIC VII (ES, ET)

Tout / All / Alle / Tutti / Todos		12.2000	09.2005	GIRL-TRW	1	54	21		X374167	X374168
		12.2000	09.2005	GIRL-TRW	1	57	21		X374761	X374762
		12.2000	09.2005	NISSIN	1	54	21		X584061	X584062
		12.2000	09.2005	NISSIN	1	34	10		X585035	X585036

Affectations par Marques

Vehicule application - Zuordnung nach Marke und Fahrzeuge - Applicazione per marca e veicolo - Aplicacion por marca y vehiculo



HONDA



CIVIC VII (EU, EP, EV) HATCHBACK

1.4 i		02.2001	09.2005	GIRL-TRW	1	54	21		X374167	X374168
		02.2001	09.2005	NISSIN	1	54	21		X584061	X584062
		02.2001	09.2005	NISSIN	1	54	23,2		X584043	X584044
1.6 i		02.2001	09.2005	GIRL-TRW	1	54	21		X374167	X374168
		02.2001	09.2005	NISSIN	1	54	21		X584061	X584062
		02.2001	09.2005	NISSIN	1	54	23,2		X584043	X584044
1.7 CTDi		01.2002	09.2005	GIRL-TRW	1	57	21		X374761	X374762
2.0 i Sport		09.2001	09.2005	NISSIN	1	54	23,2		X584043	X584044
2.0 Type-R		09.2001	09.2005	NISSIN	1	54	25		X584039	X584040
Tout / All / Alle / Tutti / Todos		02.2001	09.2005	NISSIN	1	34	10		X585035	X585036

CIVIC VIII (FD, FA)

Tout / All / Alle / Tutti / Todos		09.2005	11.2011	ATE	1	57	25/Ø293		X224837	X224838
		09.2005	11.2011	NISSIN	1	54	21/Ø262		X584053	X584054
		09.2005	11.2011	NISSIN	1	54	23/Ø282		X584057	X584058
		09.2005	11.2011	ATE	1	34	9		X225409	X225410
		09.2005	11.2011	NISSIN	1	38	9		X585047	X585048

CIVIC VIII (FN, FK)

Tout / All / Alle / Tutti / Todos		01.2006	03.2012	GIRL-TRW	1	54	23		X374755	X374756
		01.2006	03.2012	GIRL-TRW	1	34	9		X375441	X375442
Type R		09.2006	03.2012	NISSIN	1	54	25		X584059	X584060

CONCERTO (HW, MA, HWW)

Tout / All / Alle / Tutti / Todos		08.1989	03.1995	GIRL-TRW	1	54	13		X374215	X374216
		08.1989	03.1995	GIRL-TRW	1	54	21		X374167	X374168
		08.1989	03.1995	GIRL-TRW	1	30	10		X375081	X375082

CROSSTOUR

Tout / All / Alle / Tutti / Todos		01.2012		NISSIN	1	38	9		X585047	X585048
-----------------------------------	--	---------	--	--------	---	----	---	--	---------	---------

CR-V I (RD)

2.0 16V (RD1, RD3)		10.1995	02.2002	NISSIN	1	57	25		X584009	X584010
		01.1999	02.2002	AKE	1	57	23		X164301	X164302

CR-V II (RD_)

2.0		07.2002	09.2006	AKE	1	57	23/Ø282		X164301	X164302
		07.2002	09.2006	AKE	1	57	25/Ø300		X164319	X164320
		07.2002	09.2006	NISSIN	1	38	9		X585015	X585016
2.2 CTDi		02.2005	09.2006	AKE	1	57	23/Ø282		X164301	X164302
		02.2005	09.2006	AKE	1	57	25/Ø300		X164319	X164320
		02.2005	09.2006	NISSIN	1	38	9		X585047	X585048

CR-V III (RE)

Tout / All / Alle / Tutti / Todos		10.2006	06.2012	BOSCH	1	60	28		X274115	X274116
		10.2006	06.2012	BOSCH	1	38	9		X275063	X275064

Affectations par Marques

Vehicule application - Zuordnung nach Marke und Fahrzeuge - Applicazione per marca e veicolo - Aplicacion por marca y vehiculo



HONDA



CR-V IV (RM\$)

Tout / All / Alle / Tutti / Todos		01.2012		BOSCH	1	60	28		X274115	X274116
		01.2012		BOSCH	1	38	9		X275063	X275064

CRX I (AF, AS)

1.3		10.1983	10.1987	TOKICO	1	51	17		X674001	X674002
1.5 i (AF)		10.1983	11.1986	TOKICO	1	51	17		X674001	X674002
1.6 i 16V (AS)		03.1986	10.1987	AKE	1	54	19		X164045	X164046

CRX II (ED, EE)

1.4 GL		01.1990	12.1991	NISSIN	1	51	17/Ø231		X584021	X584022
1.6 i 16V		10.1987	05.1988	NISSIN	1	54	19/Ø242		X584003	X584004
1.6 i 16V (ED9)		10.1987	12.1989	NISSIN	1	54	19/Ø242		X584003	X584004
1.6 i 16V Vtec (EE8)		10.1989	02.1992	NISSIN	1	54	19/Ø242		X584003	X584004
		10.1989	02.1992	NISSIN	1	57	21/Ø262		X584005	X584006
Tout / All / Alle / Tutti / Todos		10.1987	02.1992	NISSIN	1	30	10		X585003	X585004

CRX III (EH, EG)

Tout / All / Alle / Tutti / Todos		03.1992	02.1992	NISSIN	1	54	21		X584025	X584026
		03.1992	02.1992	NISSIN	1	30	9		X585019	X585020

FR-V (BE)

Tout / All / Alle / Tutti / Todos		08.2004	07.2007	NISSIN	1	54	23,2		X584043	X584044
		08.2004	07.2007	NISSIN	1	38	12		X585039	X585040

HR-V (GH)

Tout / All / Alle / Tutti / Todos		03.1999	09.2005	NISSIN	1	57	25		X584009	X584010
-----------------------------------	--	---------	---------	--------	---	----	----	--	---------	---------

INTEGRA I (DA)

Tout / All / Alle / Tutti / Todos		10.1985	08.1989	AKE	1	54	19		X164045	X164046
		10.1985	08.1989	NISSIN	1	30	10		X585001	X585002

INTEGRA II (DC2, DC4) COUPE

1.8 Type-R		11.1997	10.2001	NISSIN	1	57	25		X584009	X584010
------------	--	---------	---------	--------	---	----	----	--	---------	---------

JAZZ I (AA)

Tout / All / Alle / Tutti / Todos		02.1984	10.1986	NISSIN	1	51	10		X584001	X584002
-----------------------------------	--	---------	---------	--------	---	----	----	--	---------	---------

JAZZ II (GD)

Tout / All / Alle / Tutti / Todos		03.2002	07.2008	NISSIN	1	51	21		X584041	X584042
		03.2002	07.2008	NISSIN	1	30	9		X585045	X585046

JAZZ III (GE, GG, GP)

Tout / All / Alle / Tutti / Todos		07.2008	09.2015	NISSIN	1	51	21		X584041	X584042
		07.2008	09.2015	NISSIN	1	30	9		X585045	X585046

LEGEND I (HS, KA)

Tout / All / Alle / Tutti / Todos		01.1988	12.1990	NISSIN	1	57	21/Ø262		X584005	X584006
		01.1988	12.1990	NISSIN	1	38	10		X585017	X585018
		01.1988	12.1990	TOKICO	1	38	10		X675019	X675020

X=1 : SNRA - X=2 : EAI - X=3 : SERA - X=4 : SEEAC - X=5 : NEOTO - X=6 : STARTCAR

Affectations par Marques

Vehicule application - Zuordnung nach Marke und Fahrzeuge - Applicazione per marca e veicolo - Aplicacion por marca y vehiculo

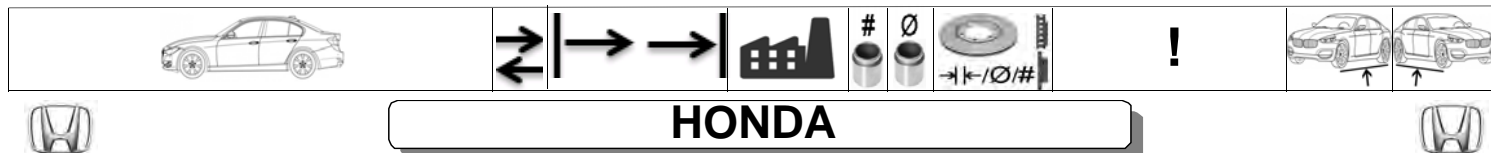

LEGEND II (KA7, KA8)

Tout / All / Alle / Tutti / Todos		01.1991	02.1996	NISSIN	2	38/42	28		X584027	X584028
		01.1991	02.1996	NISSIN	1	38	9		X585015	X585016

LEGEND III (KA9)

Tout / All / Alle / Tutti / Todos		02.1996	10.1997	NISSIN	2	38/42	28		X584027	X584028
		11.1997	09.2004	NISSIN	1	57	28		X584051	X584052
		02.1996	10.1997	NISSIN	1	38	9		X585015	X585016
		11.1997	09.2004	NISSIN	1	38	12		X585039	X585040

LEGEND IV (KB_)

Tout / All / Alle / Tutti / Todos		05.2006	12.2012	ADVICS	4	43	28		X114015	X114016
		05.2006	12.2012	NISSIN	1	40	16		X585053	X585054

LOGO (GA3)

1.3		03.1999	03.2002	NISSIN	1	51	21/Ø242		X584023	X584024
		03.1999	03.2002	NISSIN	1	54	21/Ø262		X584025	X584026

PRELUDE I (SN) COUPE

Tout / All / Alle / Tutti / Todos		11.1978	10.1982	TOKICO	1	51	17		X674001	X674002
-----------------------------------	--	---------	---------	--------	---	----	----	--	---------	---------

PRELUDE II (AB)

Tout / All / Alle / Tutti / Todos		11.1983	04.1987	AKE	1	51	19		X164049	X164050
		11.1983	04.1987	TOKICO	1	30	10		X675001	X675002

PRELUDE III (BA)

Tout / All / Alle / Tutti / Todos		04.1986	01.1992	AKE	1	54	19		X164045	X164046
		04.1986	01.1992	NISSIN	1	54	19/Ø242		X584003	X584004
		04.1986	01.1992	NISSIN	1	57	21/Ø262		X584005	X584006
		04.1986	01.1992	TOKICO	1	57	21		X674049	X674050
		04.1987	01.1992	NISSIN	1	34	10		X585011	X585012

PRELUDE IV (BB)

2.0 i 16V (BB3)		02.1992	12.1994	NISSIN	1	57	23		X584029	X584030
		01.1995	09.1996	NISSIN	1	57	23		X584033	X584034
2.2 i 16V Vtec (BB1)		02.1993	09.1996	NISSIN	1	57	25		X584009	X584010
2.3 i 16V (BB2)		02.1992	09.1996	NISSIN	1	57	25		X584009	X584010
Tout / All / Alle / Tutti / Todos		02.1992	09.1996	NISSIN	1	34	10		X585027	X585028

PRELUDE V (BB)

2.0 16V (BB9)		10.1996	10.2000	NISSIN	1	57	23		X584033	X584034
2.2 16V		10.1996	10.2000	NISSIN	1	57	25		X584009	X584010
2.2 16V (BB6, BB8)		10.1996	10.2000	NISSIN	1	57	25		X584009	X584010
Tout / All / Alle / Tutti / Todos		10.1996	10.2000	NISSIN	1	34	10		X585027	X585028

S2000 (AP)

Tout / All / Alle / Tutti / Todos		03.1999	10.2009	NISSIN	1	54	25		X584039	X584040
		03.1999	10.2009	NISSIN	1	40	12		X585037	X585038

Affectations par Marques

Vehicule application - Zuordnung nach Marke und Fahrzeuge - Applicazione per marca e veicolo - Aplicacion por marca y vehiculo



HONDA



SHUTTLE (RA)

Tout / All / Alle / Tutti / Todos		10.1994	06.2004	NISSIN	1	57	25		X584009	X584010
		10.1994	06.2004	NISSIN	1	38	9		X585015	X585016

STREAM (RN)

Tout / All / Alle / Tutti / Todos		05.2001	12.2004	NISSIN	1	54	23,2		X584043	X584044
		05.2001	12.2004	NISSIN	1	38	12		X585039	X585040



HUMBER



H1 6,5 D

6.5 D		01.1992	12.2003	K/H	1	66			X404019	X404020
		01.1992	12.2003	K/H	1	66			X405005	X405006

H1 6,5 TD

6.5 TD		01.1992	12.2003	K/H	1	66			X404019	X404020
		01.1992	12.2003	K/H	1	66			X405005	X405006

SUPER SNIPE

Tout / All / Alle / Tutti / Todos		10.1958		GIRL-TRW	2				X374483	X374484
-----------------------------------	--	---------	--	----------	---	--	--	--	---------	---------



HYUNDAI



ACCENT I (X-3)

Tout / All / Alle / Tutti / Todos		10.1994	01.2000	MANDO	1	51	19		X484003	X484004
-----------------------------------	--	---------	---------	-------	---	----	----	--	---------	---------

ACCENT II (LC)

Tout / All / Alle / Tutti / Todos		09.1999	11.2005	MANDO	1	54	19		X484001	X484002
-----------------------------------	--	---------	---------	-------	---	----	----	--	---------	---------

ACCENT III (MC)

Tout / All / Alle / Tutti / Todos		11.2005	11.2010	KASCO	1	54	22		X774005	X774006
		11.2005	11.2010	KASCO	1	30	10		X775007	X775008

ATOS (MX)

1.0 i		01.1997	12.2010	MANDO	1	50,8	18		X484045	X484046
		01.1997	12.2010	MANDO	1	51	11		X484015	X484016

COUPE I (RD)

Tout / All / Alle / Tutti / Todos		08.1996	04.2002	MANDO	1	54	22	#ID: BC140024 BC141024	X484007	X484008
		08.1996	04.2002	MANDO	1	54	24	#ID: BC140050 BC141050	X484025	X484026
		08.1996	04.2002	MANDO	1	34	10		X485005	X485006

COUPE II (GK)

Tout / All / Alle / Tutti / Todos		01.2001	08.2009	MANDO	1	54	24/Ø257		X484007	X484008
		01.2001	08.2009	MANDO	1	57	26/Ø280		X484031	X484032
		01.2001	08.2009	MANDO	1	34	10		X485005	X485006

ELANTRA I (J-1)

Tout / All / Alle / Tutti / Todos		10.1990	11.1995	MANDO	1	54	22		X484005	X484006
		10.1990	11.1995	MANDO	1	34	10		X485003	X485004

Affectations par Marques

Vehicule application - Zuordnung nach Marke und Fahrzeuge - Applicazione per marca e veicolo - Aplicacion por marca y vehiculo



HYUNDAI



ELANTRA II (J-2)

Tout / All / Alle / Tutti / Todos		09.1995	12.2000	MANDO	1	54	22	#ID: OBC039* / BC14*040	X484005	X484006
		09.1995	12.2000	MANDO	1	54	24	#ID: BC140050 BC141050	X484025	X484026

ELANTRA III (FC) LAVITA

Tout / All / Alle / Tutti / Todos		06.2001	03.2002	MANDO	1	54	24	#ID: BC140050 BC141050	X484025	X484026
		04.2002	08.2010	MANDO	1	54	24	#ID: BC140069 BC141069	X484055	X484056
		06.2001	08.2010	MANDO	1	34	10		X485007	X485008

ELANTRA III (XD)

Tout / All / Alle / Tutti / Todos		04.2001	07.2006	MANDO	1	54	22	#ID: BC140024 BC141024	X484007	X484008
		04.2001	07.2006	MANDO	1	54	24	#ID: BC140050 BC141050	X484025	X484026
		04.2001	07.2006	MANDO	1	54	24	#ID: BC140069 BC141069	X484055	X484056
		04.2001	07.2006	MANDO	1	34	10		X485005	X485006

ELANTRA IV (HD)

Tout / All / Alle / Tutti / Todos		11.2005	12.2011	MANDO	1	57	26		X484043	X484044
		11.2005	12.2011	MANDO	1	30	10		X485043	X485044

ELANTRA IV (NF)

Tout / All / Alle / Tutti / Todos		01.2005	12.2010	MANDO	1	60	28		X484075	X484076
		01.2005	12.2010	MANDO	1	34	10		X485013	X485014

GALLOPER I

2.5 TD		08.1991	07.1998	AKE	1	57	22		X164129	X164130
3.0 V6		08.1991	07.1998	AKE	1	57	22		X164127	X164128

GALLOPER II (JK-01)

Tout / All / Alle / Tutti / Todos		08.1998	12.2003	MANDO	1	57	24		X484017	X484018
-----------------------------------	--	---------	---------	-------	---	----	----	--	---------	---------

GENESIS I (BH)

Tout / All / Alle / Tutti / Todos		01.2008	12.2010	MANDO	1	60	30		X484071	X484072
		01.2011	12.2014	MANDO	1	63	30		X484073	X484074
		01.2008	12.2010	MANDO	1	43	12		X485035	X485036
		01.2011	12.2014	MANDO	1	45	12		X485037	X485038

GETZ (TB)

Tout / All / Alle / Tutti / Todos		09.2002	12.2010	MANDO	1	54	19		X484001	X484002
		09.2002	12.2010	MANDO	1	34	10		X485025	X485026

GRACE

Tout / All / Alle / Tutti / Todos		07.1993	12.2004	MANDO	1	60	20		X484013	X484014
-----------------------------------	--	---------	---------	-------	---	----	----	--	---------	---------

GRANDEUR I (XG)

Tout / All / Alle / Tutti / Todos		09.1999	12.2005	MANDO	2	43	24		X484069	X484070
		09.1999	12.2005	MANDO	1	34	10		X485007	X485008

GRANDEUR II (TG)

Tout / All / Alle / Tutti / Todos		04.2005	12.2011	MANDO	1	60	28		X484075	X484076
		04.2005	12.2011	MANDO	1	34	10		X485013	X485014

Affectations par Marques

Vehicule application - Zuordnung nach Marke und Fahrzeuge - Applicazione per marca e veicolo - Aplicacion por marca y vehiculo



HYUNDAI



H-1 I

Tout / All / Alle / Tutti / Todos		10.1997	01.2008	MANDO	2	43	24/Ø227		X484023	X484024
		10.1997	01.2008	MANDO	2	43	26/Ø274		X484079	X484080

H-1 II (TQ)

Tout / All / Alle / Tutti / Todos		02.2008		KASCO	2	48	30		X774051	X774052
		02.2008		MANDO	2	43	26		X484079	X484080
		02.2008		KASCO	1	42	18		X775033	X775034

H100 (P)

Tout / All / Alle / Tutti / Todos		07.1993	03.2000	MANDO	1	60	20		X484013	X484014
-----------------------------------	--	---------	---------	-------	---	----	----	--	---------	---------

HIGHWAY VAN

Tout / All / Alle / Tutti / Todos		03.2000	03.2004	MANDO	2	43	24		X484033	X484034
		03.2000	03.2004	MANDO	1	38	10		X485011	X485012

i10 I (PA)

Tout / All / Alle / Tutti / Todos		12.2007	12.2013	MANDO	1	50,8	20		X484061	X484062
		12.2007	12.2013	MANDO	1	34	10		X485031	X485032

i10 II (BA, IA)

Tout / All / Alle / Tutti / Todos		12.2013		MANDO	1	51	20		X484081	X484082
-----------------------------------	--	---------	--	-------	---	----	----	--	---------	---------

i20 I (PB, PBT)

Tout / All / Alle / Tutti / Todos		08.2008	12.2015	MANDO	1	51	20	E5P	X484061	X484062
		08.2008	12.2015	MANDO	1	54	22	E5P	X484063	X484064
		08.2008	12.2015	MANDO	1	30	10		X485027	X485028

i30 I (FD)

Tout / All / Alle / Tutti / Todos		10.2007	06.2012	KASCO	1	57	26/Ø280		X774023	X774024
		10.2007	06.2012	KASCO	1	57	28/Ø300		X774039	X774040
		10.2007	06.2012	KASCO	1	34	10		X775011	X775012

i30 II (GD)

Tout / All / Alle / Tutti / Todos		11.2011		KASCO	1	57	23/Ø280		X774053	X774054
		11.2011		KASCO	1	57	28/Ø300		X774055	X774056
		11.2011		KASCO	1	34	10		X775031	X775032
		11.2011		KASCO	1	34	10		X777001	X777002

i40 (VF)

Tout / All / Alle / Tutti / Todos		07.2011		KASCO	1	60	28/Ø300		X774035	X774036
		07.2011		KASCO	1	60	28/Ø320		X774037	X774038
		07.2011		MANDO	1	38	10		X485033	X485034

i45 VI

2.0 i		07.2011	06.2014	KASCO	1	60	28		X774037	X774038
		07.2011	06.2014	KASCO	1	34	10		X775017	X775018

ix20 (JC)

Tout / All / Alle / Tutti / Todos		11.2010		KASCO	1	57	26		X774045	X774046
		11.2010		KASCO	1	34	10		X475001	X475002

X=1 : SNRA - X=2 : EAI - X=3 : SERA - X=4 : SEEAC - X=5 : NEOTO - X=6 : STARTCAR

Affectations par Marques

Vehicule application - Zuordnung nach Marke und Fahrzeuge - Applicazione per marca e veicolo - Aplicacion por marca y vehiculo



HYUNDAI



ix35 (LM, EL, ELH)

Tout / All / Alle / Tutti / Todos		08.2009		KASCO	1	60	28		X774029	X774030
		08.2009		KASCO	1	34	10	A	X775015	X775016
		08.2009		KASCO	1	34	10	Fe	X775017	X775018

ix55

Tout / All / Alle / Tutti / Todos		01.2007	12.2012	KASCO	2	46	28		X774033	X774034
		01.2007	12.2012	KASCO	1	43	10		X775019	X775020

LANTRA I (J-1)

Tout / All / Alle / Tutti / Todos		10.1990	11.1995	MANDO	1	54	19/Ø242		X484001	X484002
		10.1990	11.1995	MANDO	1	54	22/Ø257		X484005	X484006
		10.1990	11.1995	MANDO	1	34	10		X485003	X485004

LANTRA II (J-2)

Tout / All / Alle / Tutti / Todos		11.1995	10.2000	MANDO	1	54	22	#ID: BC140024 BC141024	X484007	X484008
		11.1995	10.2000	MANDO	1	54	24	#ID: BC140050 BC141050	X484025	X484026
		11.1995		MANDO	1	34	10		X485005	X485006

MATRIX (FC)

1.5 CRDi		10.2001	03.2002	MANDO	1	54	24		X484025	X484026
		04.2002	08.2010	MANDO	1	54	24		X484055	X484056
1.5 CRDi VGT		08.2005	08.2010	MANDO	1	54	24		X484055	X484056
1.6		06.2001	03.2002	MANDO	1	54	24		X484025	X484026
		04.2002	08.2010	MANDO	1	54	24		X484055	X484056
1.8		06.2001	03.2002	MANDO	1	54	24		X484025	X484026
		04.2002	08.2010	MANDO	1	54	24		X484055	X484056
Tout / All / Alle / Tutti / Todos		06.2001	08.2010	MANDO	1	34	10		X485007	X485008

PONY I

1.4		08.1977	12.1985	MANDO	1	54	19		X484001	X484002
		08.1977	12.1985	SUMITOMO	1	51	13		X644035	X644036

PONY II (X-1)

Tout / All / Alle / Tutti / Todos		10.1985	12.1989	SUMITOMO	1	51	19		X644035	X644036
-----------------------------------	--	---------	---------	----------	---	----	----	--	---------	---------

PONY III (X-2)

Tout / All / Alle / Tutti / Todos		10.1989	01.1995	MANDO	1	54	19		X484001	X484002
		10.1989	01.1995	SUMITOMO	1	51	13		X644035	X644036

PONY IV (X-3)

Tout / All / Alle / Tutti / Todos		10.1994	01.2000	MANDO	1	51	19		X484003	X484004
-----------------------------------	--	---------	---------	-------	---	----	----	--	---------	---------

S COUPE (SLC)

1.5i		02.1990	05.1996	MANDO	1	54	19		X484001	X484002
------	--	---------	---------	-------	---	----	----	--	---------	---------

Affectations par Marques

Vehicule application - Zuordnung nach Marke und Fahrzeuge - Applicazione per marca e veicolo - Aplicacion por marca y vehiculo



HYUNDAI



SANTA FÉ I (SM)

Tout / All / Alle / Tutti / Todos		02.2001	03.2006	MANDO	2	43	24		X484033	X484034
		02.2001	03.2006	MANDO	2	45	28		X484053	X484054
		02.2001	12.2005	MANDO	1	38	10		X485011	X485012
		02.2001	12.2005	MANDO	1	38	10		X485012	X485011
		10.2005	03.2006	MANDO	1	43	10		X485021	X485022

SANTA FÉ II (CM)

Tout / All / Alle / Tutti / Todos		03.2006	05.2013	MANDO	2	45	28		X484053	X484054
		03.2006	08.2007	MANDO	1	43	10		X485021	X485022
		12.2010	12.2012	MANDO	1	43	10		X485045	X485046

SANTA FÉ III (DM)

Tout / All / Alle / Tutti / Todos		09.2012		MANDO	1	43	10		X485045	X485046
-----------------------------------	--	---------	--	-------	---	----	----	--	---------	---------

SANTAMO

Tout / All / Alle / Tutti / Todos		10.1998	12.2002	MANDO	2	43	24		X484033	X484034
		10.1998	12.2002	MANDO	1	38	10		X485011	X485012
		10.1998	12.2002	MANDO	1	38	10		X485012	X485011

SATELLITE

Tout / All / Alle / Tutti / Todos		06.1997	12.2007	KASCO	2	48	30		X774051	X774052
		06.1997	12.2007	MANDO	2	43	24	#ID: BC140021 BC141021	X484023	X484024
		06.1997	12.2007	MANDO	2	43	24	#ID: BC140047 BC141047	X484079	X484080

SONATA II (Y-2)

Tout / All / Alle / Tutti / Todos		09.1988	10.1993	MANDO	1	57	22		X484009	X484010
-----------------------------------	--	---------	---------	-------	---	----	----	--	---------	---------

SONATA III (Y-3)

Tout / All / Alle / Tutti / Todos		05.1993	03.1997	MANDO	1	57	22		X484029	X484030
		04.1997	06.1998	MANDO	1	57	22		X484011	X484012
		05.1993	06.1998	MANDO	1	38	12		X485001	X485002

SONATA IV (EF)

Tout / All / Alle / Tutti / Todos		03.1998	12.2005	MANDO	1	57	22		X484031	X484032
		03.1998	12.2005	MANDO	1	34	10		X485007	X485008

SONATA V (NF)

Tout / All / Alle / Tutti / Todos		01.2005	12.2010	MANDO	1	60	28		X484075	X484076
		01.2005	12.2010	MANDO	1	34	10		X485013	X485014

SONATA VI (YF)

Tout / All / Alle / Tutti / Todos		01.2009	12.2015	KASCO	1	60	28		X774043	X774044
		01.2009	12.2015	MANDO	1	60	28		X484075	X484076
		01.2009	12.2015	KASCO	1	34	10		X775017	X775018
		01.2009	12.2015	MANDO	1	34	10		X485013	X485014

TERRACAN (HP)

Tout / All / Alle / Tutti / Todos		06.2001	12.2006	MANDO	2	43	27		X484065	X484066
		06.2001	12.2006	MANDO	2	43	27		X484067	X484068
		06.2001	12.2006	MANDO	1	43	20		X485009	X485010

X=1 : SNRA - X=2 : EAI - X=3 : SERA - X=4 : SEEAC - X=5 : NEOTO - X=6 : STARTCAR

Affectations par Marques

Vehicule application - Zuordnung nach Marke und Fahrzeuge - Applicazione per marca e veicolo - Aplicacion por marca y vehiculo



HYUNDAI



TRAJET (FO)

Tout / All / Alle / Tutti / Todos		03.2000	07.2008	MANDO	2	43	24		X484033	X484034
		03.2000	07.2008	MANDO	1	38	10		X485011	X485012
		03.2000	07.2008	MANDO	1	38	10		X485012	X485011

TUCSON (JM)

Tout / All / Alle / Tutti / Todos		08.2004	11.2010	MANDO	1	60	26		X484049	X484050
		08.2004	11.2010	MANDO	1	34	10		X485023	X485024

TUCSON (LM, EL, ELH)

Tout / All / Alle / Tutti / Todos		08.2009		KASCO	1	60	28		X774029	X774030
		08.2009		KASCO	1	34	10		X775015	X775016

VELOSTER (FS)

Tout / All / Alle / Tutti / Todos		03.2011		KASCO	1	57	24		X774041	X774042
		03.2011		KASCO	1	34	10		X775021	X775022

XG (XG)

Tout / All / Alle / Tutti / Todos		12.1998	12.2005	MANDO	2	43	24		X484069	X484070
		12.1998	12.2005	MANDO	1	34	10		X485007	X485008



I.S.O.



RIVOLTA

Tout / All / Alle / Tutti / Todos		10.1968		GIRL-TRW	3	43/60			X374533	X374534
-----------------------------------	--	---------	--	----------	---	-------	--	--	---------	---------



IHC



NAVISTAR

Tout / All / Alle / Tutti / Todos		01.1991	12.1996	K/H	2	66			X794079	X794080
-----------------------------------	--	---------	---------	-----	---	----	--	--	---------	---------



INFINITI



FX 35

3.5		01.2003		AKE	1	43			X165177	X165178
-----	--	---------	--	-----	---	----	--	--	---------	---------



ISUZU



CAMPO (KB)

2.2 (TFS)		01.1989	12.1990	AKE	1	60	22		X164197	X164198
Tout / All / Alle / Tutti / Todos		01.1983	12.1990	AKE	1	57	18		X164085	X164086

KB

Tout / All / Alle / Tutti / Todos		01.1989	09.2003	AKE	1	60	22	2WD	X164197	X164198
		01.1989	09.2003	AKE	1	60	22	4WD	X164117	X164118

TROOPER I (UBS)

Tout / All / Alle / Tutti / Todos		01.1983	12.1987	AKE	1	57	18/Ø250		X164085	X164086
		12.1987	12.1991	AKE	1	60	22/Ø257		X164117	X164118
		01.1983	12.1990	NAB	1	41	10		X525003	X525004
		01.1991	12.1991	NAB	1	41	10		X525005	X525006

X=1 : SNRA - X=2 : EAI - X=3 : SERA - X=4 : SEEAC - X=5 : NEOTO - X=6 : STARTCAR

Affectations par Marques

Vehicule application - Zuordnung nach Marke und Fahrzeuge - Applicazione per marca e veicolo - Aplicacion por marca y vehiculo



ISUZU

ISUZU

ISUZU

TROOPER II (UB)

Tout / All / Alle / Tutti / Todos		08.1991	07.1998	AKE	1	60	22/Ø257		X164117	X164118
		08.1991	07.1998	AKE	1	60	26/Ø280		X164223	X164224
		08.1991	07.1998	AKE	1	42	18/Ø313		X165055	X165056
		08.1991	07.1998	NAB	1	41	10/Ø265		X525005	X525006

TROOPER III

Tout / All / Alle / Tutti / Todos		04.2000	08.2004	AKE	1	60	26		X164223	X164224
		04.2000	08.2004	AKE	1	42	18		X165055	X165056

IVECO

IVECO

IVECO

DAILY I

30-8		01.1978	12.1989	BREMBO	4	42	14,2		X284033	X284034
35-10		01.1985	12.1989	BREMBO	4	42	14,2		X284001	X284002
		01.1985	12.1989	LOCK	4	41	14,2		X464003	X464004
35-8		01.1978	12.1989	BREMBO	4	42	14,2		X284001	X284002
		01.1978	12.1989	LOCK	4	41	14,2		X464003	X464004
40-10		01.1985	12.1989	BREMBO	4	42	14,2		X284001	X284002
		01.1985	12.1989	LOCK	4	41	14,2		X464003	X464004
40-8		01.1983	06.1989	BREMBO	4	42	14,2		X284001	X284002
		01.1983	06.1989	LOCK	4	41	14,2		X464003	X464004
45-10		01.1985	12.1989	BREMBO	4	44	16		X284003	X284004
		01.1985	12.1989	PERROT	4	44	16		X614005	X614006
49-10		01.1985	12.1989	BREMBO	4	44	16		X284003	X284004
		01.1985	12.1989	PERROT	4	44	16		X614005	X614006

DAILY II

2.5 4x4		11.1989	05.1996	BREMBO	4	42	14,2		X284001	X284002
		11.1989	05.1996	BREMBO	4	42	14,2		X284033	X284034
30-10		01.1997	05.1999	BREMBO	4	42	14,2		X284001	X284002
		01.1997	05.1999	BREMBO	4	42	14,2		X284033	X284034
30-8		01.1989	05.1999	BREMBO	4	42	14,2		X284001	X284002
		01.1989	05.1999	BREMBO	4	42	14,2		X284033	X284034
35-10		01.1989	05.1999	BREMBO	2	44	22	#ID: 22.5941_	X284079	X284080
		01.1989	05.1999	BREMBO	2	44	22	#ID: 7774_	X284021	X284022
		01.1989	05.1999	BREMBO	4	42	14,2		X284001	X284002
		01.1989	05.1999	BREMBO	4	42	14,2		X284033	X284034
35-12		02.1995	05.1999	BREMBO	2	44	22	#ID: 22.5941_	X284079	X284080
		02.1995	05.1999	BREMBO	2	44	22	#ID: 7774_	X284021	X284022
		05.1996	05.1999	BREMBO	2	44	22	#ID: 22.5941_	X284079	X284080
		05.1996	05.1999	BREMBO	2	44	22	#ID: 7774_	X284021	X284022
35-8		01.1989	05.1999	BREMBO	2	44	22	#ID: 22.5941_	X284079	X284080
		01.1989	05.1999	BREMBO	2	44	22	#ID: 7774_	X284021	X284022
40-10 W 4x4		01.1997	05.1999	BREMBO	2	44	22	#ID: 22.5941_	X284079	X284080

X=1 : SNRA - X=2 : EAI - X=3 : SERA - X=4 : SEEAC - X=5 : NEOTO - X=6 : STARTCAR

Affectations par Marques

Vehicule application - Zuordnung nach Marke und Fahrzeuge - Applicazione per marca e veicolo - Aplicacion por marca y vehiculo



IVECO

DAILY II

49-10		05.1996	05.1999	BREMBO	2	44	22	#ID: 22.5941_	X284079	X284080
		05.1996	05.1999	BREMBO	2	44	22	#ID: 7774_	X284021	X284022
49-12		05.1996	05.1999	BREMBO	2	44	22	#ID: 22.5941_	X284079	X284080
		05.1996	05.1999	BREMBO	2	44	22	#ID: 7774_	X284021	X284022
A 40-10		09.1996	05.1999	BREMBO	2	44	22	#ID: 22.5941_	X284079	X284080
		09.1996	05.1999	BREMBO	2	44	22	#ID: 7774_	X284021	X284022
A 40-12		05.1996	05.1999	BREMBO	2	44	22	#ID: 22.5941_	X284079	X284080
		05.1996	05.1999	BREMBO	2	44	22	#ID: 7774_	X284021	X284022
A 45-10		05.1996	05.1999	BREMBO	2	44	22	#ID: 22.5941_	X284079	X284080
		05.1996	05.1999	BREMBO	2	44	22	#ID: 7774_	X284021	X284022
A 45-12		05.1996	05.1999	BREMBO	2	44	22	#ID: 22.5941_	X284079	X284080
		05.1996	05.1999	BREMBO	2	44	22	#ID: 7774_	X284021	X284022
Tout / All / Alle / Tutti / Todos		01.1989	05.1999	BREMBO	2	44	22/Ø280		X285039	X285040
		01.1989	05.1999	BREMBO	2	44	22/Ø289		X285037	X285038

DAILY III (29L_)

Tout / All / Alle / Tutti / Todos		05.1999	12.2006	BREMBO	2	42	22/Ø276	#ID: 7221.0_	X284037	X284038
		05.1999	12.2006	BREMBO	2	44	22/Ø276	#ID: 9273.0_	X284137	X284138
		05.1999	12.2006	BREMBO	1	52	16		X285021	X285022

DAILY III (35C, 40C, 45C, 50C)

Tout / All / Alle / Tutti / Todos		05.1999	12.2006	BREMBO	2	44	22/Ø276	#ID: 9273.0_	X284137	X284138
		05.1999	12.2006	BREMBO	2	44	22/Ø290	#ID: 22.5941_	X284079	X284080
		05.1999	12.2006	BREMBO	2	44	22/Ø290	#ID: 7774.0_	X284021	X284022
		05.1999	12.2006	BREMBO	2	44	22/Ø280		X285039	X285040
		05.1999	12.2006	BREMBO	2	44	22/Ø289		X285037	X285038

DAILY III (35S, 40S)

Tout / All / Alle / Tutti / Todos		05.1999	12.2006	BREMBO	2	42	22/Ø276	#ID: 7221.0_	X284037	X284038
		05.1999	12.2006	BREMBO	2	44	22/Ø276	#ID: 9273.0_	X284137	X284138
		05.1999	12.2006	BREMBO	2	44	22/Ø290	#ID: 22.5941_	X284079	X284080
		05.1999	12.2006	BREMBO	1	52	16		X285021	X285022

DAILY III (65C)

Tout / All / Alle / Tutti / Todos		09.2004	04.2006	BREMBO	2	52	26		X284091	X284092
		09.2004	04.2006	BREMBO	2	46	22		X285029	X285030

DAILY III/break

2.8 CNG		05.1999	12.2006	BREMBO	2	42	22/Ø276	#ID: 7221.0_	X284037	X284038
		05.1999	12.2006	BREMBO	2	44	22/Ø290	#ID: 22.5941_	X284079	X284080
		05.1999	12.2006	BREMBO	2	44	22/Ø290	#ID: 7774.0_	X284021	X284022
		05.1999	12.2006	BREMBO	1	52	16		X285021	X285022
		05.1999	12.2006	BREMBO	2	44	22/Ø280		X285039	X285040
		05.1999	12.2006	BREMBO	2	44	22/Ø289		X285037	X285038

Affectations par Marques

Vehicule application - Zuordnung nach Marke und Fahrzeuge - Applicazione per marca e veicolo - Aplicacion por marca y vehiculo



IVECO

IVECO

IVECO

DAILY IV (29L)

Tout / All / Alle / Tutti / Todos		05.2006		BREMBO	2	48	28/Ø300		X284105	X284106
		05.2006		BREMBO	1	52	16/Ø276 -296		X285021	X285022

DAILY IV (35C)

Tout / All / Alle / Tutti / Todos		05.2006		BREMBO	2	48	28/Ø300		X284105	X284106
		05.2006		BREMBO	1	60	24/Ø294		X285051	X285052

DAILY IV (35S)

Tout / All / Alle / Tutti / Todos		05.2006		BREMBO	2	48	28/Ø300		X284105	X284106
		05.2006		BREMBO	1	52	16		X285021	X285022

DAILY IV (40C, 45C, 50C)

Tout / All / Alle / Tutti / Todos		05.2006		BREMBO	2	48	28/Ø300		X284105	X284106
		05.2006		BREMBO	2	44	22/Ø289		X285037	X285038

DAILY IV (55C)

Tout / All / Alle / Tutti / Todos		05.2006		BREMBO	2	48	28/Ø300		X284105	X284106
		05.2006		BREMBO	1	60	24/Ø294		X285051	X285052
		05.2006		BREMBO	2	44	22/Ø289		X285037	X285038

DAILY IV (60C, 65C, 70C)

Tout / All / Alle / Tutti / Todos		05.2006		BREMBO	2	60	30		X284103	X284104
		05.2006		BREMBO	2	48	28/Ø306		X285049	X285050

DAILY V (26L, 29L)

Tout / All / Alle / Tutti / Todos		09.2011		BREMBO	2	48	28		X284105	X284106
		09.2011		BREMBO	1	52	16/Ø276 -296		X285021	X285022

DAILY V (35C)

Tout / All / Alle / Tutti / Todos		09.2011		BREMBO	2	48	28		X284105	X284106
		09.2011		BREMBO	1	60	24/Ø294		X285051	X285052

DAILY V (35S)

Tout / All / Alle / Tutti / Todos		09.2011		BREMBO	2	48	28		X284105	X284106
		09.2011		BREMBO	1	52	16/Ø276 -296		X285021	X285022

DAILY V (40C, 45C, 50C, 60C, 65C, 70C)

Tout / All / Alle / Tutti / Todos		09.2011		BREMBO	2	48	28		X284105	X284106
		09.2011		BREMBO	2	60	30		X284103	X284104
		09.2011		BREMBO	1	60	24/Ø294		X285051	X285052
		09.2011		BREMBO	2	48	28/Ø306		X285049	X285050

DAILY VI (35C)

Tout / All / Alle / Tutti / Todos		03.2014		BREMBO	2	48	28		X284105	X284106
		03.2014		BREMBO	1	60	24/Ø294		X285051	X285052
		03.2014		BREMBO	2	48	28/Ø306		X285049	X285050

DAILY VI (35S)

Tout / All / Alle / Tutti / Todos		03.2014		BREMBO	2	48	28		X284105	X284106
		03.2014		BREMBO	1	52	16/Ø276 -296		X285021	X285022
		03.2014		BREMBO	2	48	28/Ø306		X285049	X285050

X=1 : SNRA - X=2 : EAI - X=3 : SERA - X=4 : SEEAC - X=5 : NEOTO - X=6 : STARTCAR

Affectations par Marques

Vehicule application - Zuordnung nach Marke und Fahrzeuge - Applicazione per marca e veicolo - Aplicacion por marca y vehiculo



IVECO

IVECO

IVECO

DAILY VI (40C, 45C, 50C, 60C, 65C, 70C)

Tout / All / Alle / Tutti / Todos		03.2014		BREMBO	2	48	28		X284105	X284106
		03.2014		BREMBO	2	60	30		X284103	X284104
		03.2014		BREMBO	1	60	24/Ø294		X285051	X285052
		03.2014		BREMBO	2	48	28/Ø306		X285049	X285050

JAGUAR

JAGUAR

JAGUAR

E-TYPE

Tout / All / Alle / Tutti / Todos		07.1968	12.1975	GIRL-TRW	3	40/57	12,7		X374321	X374322
		07.1968	12.1975	GIRL-TRW	3	40/57	24		X374509	X374510
		07.1968	12.1975	GIRL-TRW	2	43	12,7		X375107	X375108

F-TYPE (QQ6)

Tout / All / Alle / Tutti / Todos		10.2012		GIRL-TRW	41			Jante17	X377065	X377066
		10.2012		GIRL-TRW	41			Jante19	X377061	X377062

S-TYPE (CCX)

2.5 V6		04.2002	10.2007	GIRL-TRW	2	38/45	30		X374665	X374666
		04.2002	10.2007	GIRL-TRW	1	43	20		X375213	X375214
		04.2002	10.2007	GIRL-TRW	1	43	20		X375401	X375402
2.7 D		06.2004	10.2007	GIRL-TRW	2	38/45	30		X374665	X374666
		06.2004	10.2007	GIRL-TRW	1	43	20		X375401	X375402
3.0 V6		01.1999	10.2007	ATE	1	60	30/Ø326		X224687	X224688
		01.1999	10.2007	GIRL-TRW	2	38/45	30		X374665	X374666
		01.1999	04.2002	GIRL-TRW	1	43	20		X375213	X375214
		05.2002	10.2007	GIRL-TRW	1	43	20		X375401	X375402
4.0 V8		01.1999	04.2002	GIRL-TRW	2	38/45	30		X374665	X374666
		01.1999	04.2002	GIRL-TRW	1	43	20		X375213	X375214
4.2 Supercharged		11.2001	12.2008	BREMBO	4	38/44	30		X284227	X284228
		11.2001	05.2002	GIRL-TRW	2	38/45	30		X374665	X374666
		11.2001	12.2008	BREMBO	4	28/30	20		X285097	X285098
		11.2001	05.2002	GIRL-TRW	1	43	20		X375213	X375214
4.2 V8		04.2002	10.2007	GIRL-TRW	2	38/45	30		X374665	X374666
		04.2002	10.2007	GIRL-TRW	1	43	20		X375213	X375214
		04.2002	10.2007	GIRL-TRW	1	43	20		X375401	X375402
R 4,2 V8		04.2002	10.2007	BREMBO	4	38/44	30		X284227	X284228
		04.2002	10.2007	GIRL-TRW	2	38/45	30		X374665	X374666
		04.2002	10.2007	BREMBO	4	28/30	20		X285097	X285098
		04.2002	10.2007	GIRL-TRW	1	43	20		X375213	X375214

XF (CC9)

Tout / All / Alle / Tutti / Todos		03.2008	04.2015	ATE	1	60	30/Ø326		X224687	X224688
		03.2008	04.2015	ATE	2	42	36		X224905	X224906
		03.2008	04.2015	ATE	1	45	20		X225345	X225346

X=1 : SNRA - X=2 : EAI - X=3 : SERA - X=4 : SEEAC - X=5 : NEOTO - X=6 : STARTCAR

Affectations par Marques

Vehicule application - Zuordnung nach Marke und Fahrzeuge - Applicazione per marca e veicolo - Aplicacion por marca y vehiculo



JAGUAR



XJ

Tout / All / Alle / Tutti / Todos		09.1968	09.1994	GIRL-TRW	3	40/57	12,7		X374321	X374322
		09.1968	09.1994	GIRL-TRW	3	40/57	24		X374509	X374510
		09.1968	09.1994	GIRL-TRW	4	48	24,2		X374217	X374218
		09.1968	09.1994	GIRL-TRW	2	43	12,7		X375107	X375108

XJ (NAW, NBW)

Tout / All / Alle / Tutti / Todos		07.1997	05.2003	ATE	1	60	28/Ø291		X224487	X224488
		07.1997	05.2003	ATE	1	60	28/Ø305		X224517	X224518
		07.1997	05.2003	GIRL-TRW	1	60	22		X374375	X374376
		07.1997	05.2003	ATE	1	36	10		X225185	X225186
		07.1997	05.2003	GIRL-TRW	1	36	10		X375125	X375126

XJ (X300, X330)

Tout / All / Alle / Tutti / Todos		11.1994	07.1997	ATE	1	60	28		X224487	X224488
		11.1994	07.1997	GIRL-TRW	1	60	22		X374375	X374376
		11.1994	07.1997	ATE	1	48	20		X225255	X225256
		11.1994	07.1997	GIRL-TRW	1	36	10		X375125	X375126

XJ (X350, X358)

2,7 D		10.2005	03.2009	ATE	1	60	30		X224687	X224688
		10.2005	03.2009	GIRL-TRW	2	38/45	30		X374665	X374666
		10.2005	03.2009	ATE	1	45	20		X225345	X225346
		10.2005	03.2009	GIRL-TRW	1	43	20		X375467	X375468
3.0		05.2003	03.2009	GIRL-TRW	2	38/45	30		X374665	X374666
		05.2003	03.2009	GIRL-TRW	1	43	20		X375467	X375468
3.5		05.2003	03.2009	GIRL-TRW	2	38/45	30		X374665	X374666
		05.2003	03.2009	GIRL-TRW	1	43	20		X375467	X375468
4.2		05.2003	03.2009	GIRL-TRW	2	38/45	30		X374665	X374666
		05.2003	03.2009	GIRL-TRW	1	43	20		X375467	X375468
R 4.2		05.2003	03.2009	BREMBO	4	38/44	30		X284227	X284228
		05.2003	03.2009	BREMBO	4	28/30	20		X285097	X285098

XJ (X351)

5.0 V8		10.2009		ATE	2	42	36		X224905	X224906
Tout / All / Alle / Tutti / Todos		10.2009		ATE	1	45	20		X225345	X225346

XJ (XJ 40, 81)

6 2.9		10.1986	08.1990	GIRL-TRW	1	36	10		X375125	X375126
6 3.2 24V		09.1990	11.1994	ATE	1	36	10		X225185	X225186
		09.1990	11.1994	ATE	1	36	10		X225213	X225214
		09.1990	11.1994	GIRL-TRW	1	36	10		X375125	X375126
6 3.6		10.1986	08.1989	GIRL-TRW	1	36	10		X375125	X375126
6 4.0		09.1989	11.1994	GIRL-TRW	1	36	10		X375125	X375126
Tout / All / Alle / Tutti / Todos		10.1986	11.1994	ATE	1	60	28		X224487	X224488
		10.1986	11.1994	GIRL-TRW	1	60	22		X374375	X374376
V12 6.0		03.1993	11.1994	GIRL-TRW	1	36	10		X375125	X375126

X=1 : SNRA - X=2 : EAI - X=3 : SERA - X=4 : SEEAC - X=5 : NEOTO - X=6 : STARTCAR

Affectations par Marques

Vehicule application - Zuordnung nach Marke und Fahrzeuge - Applicazione per marca e veicolo - Aplicacion por marca y vehiculo



JAGUAR



XJSC

Tout / All / Alle / Tutti / Todos		09.1985	09.1994	GIRL-TRW	4	48	24,2		X374217	X374218
		09.1985	09.1994	GIRL-TRW	2	43	12,7		X375107	X375108

XK (_J43_)

3.5		07.2007	12.2008	ATE	1	60	30/Ø326		X224687	X224688
3.6		10.2007	12.2008	ATE	1	60	30/Ø326		X224687	X224688
4.2 XK8		03.2006		ATE	1	60	30/Ø326		X224687	X224688
5.0 XKR		01.2009		ATE	2	42	36		X224905	X224906
5.0 XKR-S		01.2011		ATE	2	42	36		X224905	X224906
Tout / All / Alle / Tutti / Todos		03.2006		ATE	1	45	20		X225345	X225346

XK (QQ6_ , _J43_)

Tout / All / Alle / Tutti / Todos		09.2007		ATE	1	60	30		X224687	X224688
		09.2007		ATE	1	45	20		X225345	X225346

XK 8 (X100, QDV) CONVERTIBLE

Tout / All / Alle / Tutti / Todos		03.1996	07.2005	ATE	1	60	28	#ID: 33	X224487	X224488
		03.1996	07.2005	ATE	1	36	10		X225185	X225186

XK 8 (X100, QDV) COUPE

Tout / All / Alle / Tutti / Todos		03.1996	07.2005	ATE	1	60	28	#ID: 31	X224517	X224518
		03.1996	07.2005	ATE	1	60	28	#ID: 33	X224487	X224488
		03.1996	07.2005	ATE	1	36	10		X225185	X225186

X-TYPE

Tout / All / Alle / Tutti / Todos		06.2001	12.2009	BOSCH	1	57	24		X274045	X274046
		06.2001	12.2009	BOSCH	1	38	12	->E24053	X275029	X275030
		06.2001	12.2009	BOSCH	1	38	12	E24054->	X275057	X275058



JEEP



CHEROKEE I (XJ)

Tout / All / Alle / Tutti / Todos		10.1984	09.2001	K/H	1	66	24	4x2	X794039	X794040
		10.1984	09.2001	K/H	1	66	24	4x4	X794035	X794036

CHEROKEE II (KJ)

Tout / All / Alle / Tutti / Todos		09.2001	01.2008	GIRL-TRW	1	66			X374711	X374712
-----------------------------------	--	---------	---------	----------	---	----	--	--	---------	---------

CHEROKEE III (KK)

Tout / All / Alle / Tutti / Todos		01.2008	03.2013	GIRL-TRW	1	66	28		X374729	X374730
		01.2008	03.2013	GIRL-TRW	1	66	28		X374731	X374732
		01.2008	03.2013	GIRL-TRW	1	48	12		X375435	X375436

COMMANDER (XK, XH)

Tout / All / Alle / Tutti / Todos		09.2005	12.2010	K/H	2	48	30		X794125	X794126
		09.2005	12.2010	K/H	1	48	14		X795031	X795032

Affectations par Marques

Vehicule application - Zuordnung nach Marke und Fahrzeuge - Applicazione per marca e veicolo - Aplicacion por marca y vehiculo



Jeep

JEEP

Jeep

COMPASS I (MK49)

Tout / All / Alle / Tutti / Todos		08.2006		AKE	1	57	26		X164317	X164318
		08.2006		GIRL-TRW	1	66	28		X374729	X374730
		08.2006		GIRL-TRW	1	66	28		X374731	X374732
		08.2006		AKE	1	35	10/Ø262		X165193	X165194
		08.2006		AKE	1	35	10/Ø302		X165187	X165188

GRAND CHEROKEE I (ZJ)

Tout / All / Alle / Tutti / Todos		09.1991	04.1999	K/H	1	66	24		X794035	X794036
		09.1991	04.1999	K/H	1	66	28		X795001	X795002

GRAND CHEROKEE II (WJ, WG)

Tout / All / Alle / Tutti / Todos		04.1999	09.2005	AKE	2	48	26		X164297	X164298
		04.1999	09.2005	ATE	2	48	26		X224607	X224608
		04.1999	09.2005	K/H	2	48	30		X794125	X794126
		04.1999	09.2005	ATE	1	48	10		X225231	X225232
		04.1999	09.2005	K/H	1	48	14		X795031	X795032

GRAND CHEROKEE III (WH, WK)

Tout / All / Alle / Tutti / Todos		06.2005	12.2010	K/H	2	48	30		X794125	X794126
		06.2005	12.2010	K/H	1	48	14		X795031	X795032

PATRIOT (MK74)

Tout / All / Alle / Tutti / Todos		02.2007		AKE	1	57	26		X164317	X164318
		02.2007		AKE	1	35	10/Ø262		X165193	X165194
		02.2007		AKE	1	35	10/Ø302		X165187	X165188

WRANGLER I (YJ, SJ)

Tout / All / Alle / Tutti / Todos		01.1987	12.1989	K/H	1	66	28		X794035	X794036
		01.1987	12.1989	K/H	1	66	28		X794049	X794050

WRANGLER II (TJ)

Tout / All / Alle / Tutti / Todos		08.1996	12.2008	GIRL-TRW	1	66	28		X374729	X374730
		08.1996	12.2008	GIRL-TRW	1	66	28		X374731	X374732
		08.1996	12.2008	K/H	1	66	24		X794035	X794036

WRANGLER III (JK)

Tout / All / Alle / Tutti / Todos		04.2007		GIRL-TRW	1	66	28		X374729	X374730
		04.2007		GIRL-TRW	1	66	28		X374731	X374732
		04.2007		GIRL-TRW	1	48	12		X375435	X375436

JENSEN

INTERCEPTOR MK I

Tout / All / Alle / Tutti / Todos		10.1968	08.1969	GIRL-TRW	3	40/57			X374461	X374462
-----------------------------------	--	---------	---------	----------	---	-------	--	--	---------	---------

INTERCEPTOR MK II

Tout / All / Alle / Tutti / Todos		09.1969	09.1971	GIRL-TRW	3	40/57			X374461	X374462
-----------------------------------	--	---------	---------	----------	---	-------	--	--	---------	---------

X=1 : SNRA - X=2 : EAI - X=3 : SERA - X=4 : SEEAC - X=5 : NEOTO - X=6 : STARTCAR

Affectations par Marques

Vehicule application - Zuordnung nach Marke und Fahrzeuge - Applicazione per marca e veicolo - Aplicacion por marca y vehiculo



KIA



BONGO III

Tout / All / Alle / Tutti / Todos		10.2003		KASCO	1	60	24		X774013	X774014
-----------------------------------	--	---------	--	-------	---	----	----	--	---------	---------

CARENS I (FC)

Tout / All / Alle / Tutti / Todos		11.2000	07.2002	KPW	1	57	24		X414007	X414008
		11.2000	07.2002	KPW	1	34	10		X415001	X415002

CARENS II (FJ)

Tout / All / Alle / Tutti / Todos		07.2002	12.2006	KASCO	1	57	26		X774027	X774028
		07.2002	12.2006	KASCO	1	38	10		X775001	X775002

CARENS III (UN)

Tout / All / Alle / Tutti / Todos		09.2006	02.2013	KASCO	1	60	26		X774025	X774026
		09.2006	02.2013	KASCO	1	38	10		X775013	X775014

CARNIVAL I (UP)

Tout / All / Alle / Tutti / Todos		08.1999	10.2001	KASCO	1	66	24		X774007	X774008
		08.1999	10.2001	KASCO	2	46	24		X774001	X774002

CARNIVAL II (GQ)

Tout / All / Alle / Tutti / Todos		01.1999	09.2007	KASCO	1	66	24		X774007	X774008
		01.1999	09.2007	KASCO	2	46	24		X774001	X774002
		01.1999	09.2007	KASCO	2	46	26		X774009	X774010

CARNIVAL III/ GRAND CARNIVAL III (VQ)

Tout / All / Alle / Tutti / Todos		06.2006		KASCO	2	51	28		X774017	X774018
		06.2006		KASCO	1	43	12		X775025	X775026

CEE'D I (ED)

Tout / All / Alle / Tutti / Todos		12.2006	12.2012	KASCO	1	57	26		X774023	X774024
		12.2006	12.2012	KASCO	1	34	10		X775011	X775012

CEE'D II (JD)

Tout / All / Alle / Tutti / Todos		05.2012		KASCO	1	57	23/Ø280		X774053	X774054
		05.2012		KASCO	1	57	28/Ø300		X774055	X774056
		05.2012		KASCO	1	34	10		X777001	X777002

CERATO I

Tout / All / Alle / Tutti / Todos		10.2001	12.2004	KASCO	1	54	20		X774031	X774032
		10.2001	12.2004	KPW	1	34	10		X415001	X415002

CERATO II

1.5 CRDi		07.2005	08.2006	MANDO	1	34	10		X485015	X485016
1.6		04.2004	11.2004	MANDO	1	34	10		X485005	X485006
		12.2004	01.2007	MANDO	1	34	10		X485015	X485016
1.6 CRDi		06.2005	06.2008	MANDO	1	34	10		X485015	X485016
1.8		08.2005	06.2008	MANDO	1	34	10		X485015	X485016
2.0		04.2004	11.2004	MANDO	1	34	10		X485005	X485006
		12.2004	01.2007	MANDO	1	34	10		X485015	X485016
2.0 CRDi		04.2004	11.2004	MANDO	1	34	10		X485005	X485006
		12.2004	05.2006	MANDO	1	34	10		X485015	X485016

X=1 : SNRA - X=2 : EAI - X=3 : SERA - X=4 : SEEAC - X=5 : NEOTO - X=6 : STARTCAR

Affectations par Marques

Vehicule application - Zuordnung nach Marke und Fahrzeuge - Applicazione per marca e veicolo - Aplicacion por marca y vehiculo

								
KIA								
CERATO II								
Tout / All / Alle / Tutti / Todos		04.2004	01.2007	MANDO	1	57	26	X484047 X484048
CLARUS (K9A)								
Tout / All / Alle / Tutti / Todos		07.1996	11.2001	ATE	1	57	24	X224465 X224466
		07.1996	11.2001	KPW	1	57	24	X414007 X414008
		07.1996	11.2001	KPW	1	34	10	X415001 X415002
CLARUS Break(GC)								
Tout / All / Alle / Tutti / Todos		05.1998	11.2001	KPW	1	57	24	X414007 X414008
		05.1998	11.2001	KPW	1	34	10	X415001 X415002
JOICE								
Tout / All / Alle / Tutti / Todos		02.2000	12.2003	MANDO	1	54	22	X484007 X484008
K2500 (SD)								
Tout / All / Alle / Tutti / Todos		01.2003		KASCO	1	60	24	X774013 X774014
K2700 (K62W)(SD)								
2.7 D		03.1997	12.2004	KASCO	1	60	24	X774013 X774014
K2900								
Tout / All / Alle / Tutti / Todos		01.2008		KASCO	1	60	24	X774013 X774014
MAGENTIS I (GD, MS)								
Tout / All / Alle / Tutti / Todos		05.2001	12.2005	MANDO	1	57	24,5	X484039 X484040
		05.2001	12.2005	MANDO	1	57	24,5	X484041 X484042
		05.2001	12.2005	MANDO	1	34	10	X485007 X485008
MAGENTIS II (MG)								
Tout / All / Alle / Tutti / Todos		11.2005		MANDO	1	57	26	X484043 X484044
		11.2005		MANDO	1	34	10	X485013 X485014
OPTIMA								
Tout / All / Alle / Tutti / Todos		06.2010	12.2015	MANDO	1	60	30	#ID: BC140135 X484071 X484072
		06.2010	12.2015	MANDO	1	38	10	X487001 X487002
PICANTO I (BA)								
Tout / All / Alle / Tutti / Todos		04.2004	04.2011	KASCO	1	51	18	X774011 X774012
		04.2004	01.2005	KASCO	1	34	10	X775005 X775006
		02.2005	04.2011	KASCO	1	34	10	X775009 X775010
PICANTO II (TA)								
Tout / All / Alle / Tutti / Todos		05.2011		KASCO	1	51	18	X774049 X774050
		05.2011		KASCO	1	34	10	X775029 X775030
PREGIO								
Tout / All / Alle / Tutti / Todos		08.1995	09.2004	KASCO	2	46	26	X774015 X774016
PRIDE I (DA)								
Tout / All / Alle / Tutti / Todos		01.1990	09.2001	SUMITOMO	1	48	13	X644065 X644066

Affectations par Marques

Vehicule application - Zuordnung nach Marke und Fahrzeuge - Applicazione per marca e veicolo - Aplicacion por marca y vehiculo



KIA



PRIDE II (JB)

Tout / All / Alle / Tutti / Todos		03.2005	12.2011	KASCO	1	54	22		X774005	X774006
		03.2005	12.2011	KASCO	1	30	10		X775007	X775008

PRO CEE'D I (ED)

Tout / All / Alle / Tutti / Todos		02.2008	02.2013	KASCO	1	57	26		X774023	X774024
		02.2008	02.2013	KASCO	1	34	10		X775011	X775012

PRO CEE'D II (JD)

Tout / All / Alle / Tutti / Todos		03.2013		KASCO	1	57	23/Ø280		X774053	X774054
		03.2013		KASCO	1	57	28/Ø300		X774055	X774056
		03.2013		KASCO	1	34	10		X777001	X777002

RETONA (CE)

Tout / All / Alle / Tutti / Todos		06.1999		KPW	1	57	24		X414003	X414004
-----------------------------------	--	---------	--	-----	---	----	----	--	---------	---------

RIO I (DC)

1.3		08.2000	08.2001	KASCO	1	51	22/Ø235		X774019	X774020
		08.2000	02.2005	KASCO	1	54	24/Ø254		X774021	X774022
		08.2000	07.2001	KPW	1	51	22/Ø235		X414005	X414006
1.5		09.2002	02.2005	KPW	1	51	22/Ø235		X414005	X414006
1.5 16V		06.2001	07.2002	KASCO	1	51	22/Ø235		X774019	X774020
		06.2001	07.2001	KPW	1	51	22/Ø235		X414005	X414006
		08.2002	02.2005	KASCO	1	54	24/Ø254		X774021	X774022

RIO II (JB)

Tout / All / Alle / Tutti / Todos		03.2005	03.2011	KASCO	1	54	22		X774005	X774006
		03.2005	03.2011	KASCO	1	30	10		X775007	X775008

SEPHIA (FA, FB)

Tout / All / Alle / Tutti / Todos		09.1993	10.2001	ATE	1	54	20		X224451	X224452
		09.1993	10.2001	ATE	2	33	10		X225115	X225116

SHUMA I

1.5		03.1996	10.1997	ATE	1	54	20		X224451	X224452
		03.1996	10.1997	ATE	2	33	10		X225115	X225116
1.5 i 16V		10.1997	10.2001	ATE	1	54	20		X224451	X224452
		10.1997	03.2001	ATE	2	33	10		X225115	X225116
		10.1997	10.2001	KPW	1	34	10		X415001	X415002
1.6		01.2001	12.2001	KASCO	1	54	20		X774031	X774032
		01.2001	12.2001	KPW	1	34	10		X415001	X415002
1.8 i 16V		10.1997	03.2001	ATE	1	54	20		X224451	X224452
		10.1997	03.2001	ATE	2	33	10		X225115	X225116

SHUMA II

Tout / All / Alle / Tutti / Todos		05.2001		KASCO	1	54	20		X774031	X774032
		05.2001		KPW	1	34	10		X415001	X415002

SORENTO I (JC)

2.4		08.2002	06.2009	KASCO	2	46	28		X774003	X774004
-----	--	---------	---------	-------	---	----	----	--	---------	---------

X=1 : SNRA - X=2 : EAI - X=3 : SERA - X=4 : SEEAC - X=5 : NEOTO - X=6 : STARTCAR

Affectations par Marques

Vehicule application - Zuordnung nach Marke und Fahrzeuge - Applicazione per marca e veicolo - Aplicacion por marca y vehiculo



KIA



SORENTO I (JC)

2.5 CRDi (140)		08.2002	03.2011	KASCO	2	46	28		X774003	X774004
2.5 CRDi (163/170)		05.2006	12.2011	KASCO	2	46	28		X774047	X774048
3.3 V6		11.2007	12.2011	KASCO	2	46	28		X774003	X774004
3.3 V6 4WD		02.2007	12.2011	KASCO	2	46	28		X774047	X774048
3.5 V6		08.2002	12.2011	KASCO	2	46	28		X774003	X774004
3.5 V6 4WD		08.2002	12.2011	KASCO	2	46	28		X774003	X774004
Tout / All / Alle / Tutti / Todos		08.2002	12.2011	KASCO	1	43	20		X775003	X775004

SORENTO II (XM)

Tout / All / Alle / Tutti / Todos		11.2009	12.2015	MANDO	2	45	28		X484053	X484054
		11.2009	12.2015	MANDO	1	43	10		X485045	X485046

SOUL I (AM)

Tout / All / Alle / Tutti / Todos		02.2009	12.2014	MANDO	1	57	26		X484043	X484044
		02.2009	12.2014	MANDO	1	34	10		X485041	X485042

SPORTAGE I (K00)

Tout / All / Alle / Tutti / Todos		04.1994	08.2003	K/H	1	54	24		X404013	X404014
		04.1994	08.2003	KPW	1	57	24		X414003	X414004

SPORTAGE II (JE_, KM_)

Tout / All / Alle / Tutti / Todos		09.2004	12.2010	KASCO	1	60	28		X774057	X774058
		09.2004	12.2010	MANDO	1	60	26		X484049	X484050
		09.2004	12.2010	MANDO	1	34	10		X485023	X485024

SPORTAGE III (SL)

Tout / All / Alle / Tutti / Todos		07.2010	12.2015	KASCO	1	60	28		X774029	X774030
		07.2010	12.2015	KASCO	1	34	10		X775015	X775016
		07.2010	12.2015	KASCO	1	34	10		X775017	X775018

VENGA (YN)

Tout / All / Alle / Tutti / Todos		02.2010		GIRL-TRW	1	57	26		X374727	X374728
		02.2010		GIRL-TRW	1	34	10		X375449	X375450



LADA



1200-1500 Break

Tout / All / Alle / Tutti / Todos		09.1973	08.1984	LADA	2	48	10		X434003	X434004
-----------------------------------	--	---------	---------	------	---	----	----	--	---------	---------

1200-1600

Tout / All / Alle / Tutti / Todos		01.1970	12.2005	LADA	2	48	10		X434003	X434004
-----------------------------------	--	---------	---------	------	---	----	----	--	---------	---------

KALINKA (2104) Break

Tout / All / Alle / Tutti / Todos		09.1985	04.2012	LADA	2	48	10		X434003	X434004
-----------------------------------	--	---------	---------	------	---	----	----	--	---------	---------

KALINKA (2105)

Tout / All / Alle / Tutti / Todos		05.1981	04.2012	LADA	2	48	10		X434003	X434004
-----------------------------------	--	---------	---------	------	---	----	----	--	---------	---------

NIVA I (2121)

Tout / All / Alle / Tutti / Todos		12.1976	12.2010	LADA	3	30	11		X434005	X434006
-----------------------------------	--	---------	---------	------	---	----	----	--	---------	---------

X=1 : SNRA - X=2 : EAI - X=3 : SERA - X=4 : SEEAC - X=5 : NEOTO - X=6 : STARTCAR

Affectations par Marques

Vehicule application - Zuordnung nach Marke und Fahrzeuge - Applicazione per marca e veicolo - Aplicacion por marca y vehiculo



LADA



NIVA II (2123)

Tout / All / Alle / Tutti / Todos		09.2002		LADA	3	30	11		X434005	X434006
-----------------------------------	--	---------	--	------	---	----	----	--	---------	---------

NOVA (2104) Break

Tout / All / Alle / Tutti / Todos		09.1981	04.2012	LADA	2	48	10		X434003	X434004
-----------------------------------	--	---------	---------	------	---	----	----	--	---------	---------

NOVA (2105)

Tout / All / Alle / Tutti / Todos		09.1981	04.2012	LADA	2	48	10		X434003	X434004
-----------------------------------	--	---------	---------	------	---	----	----	--	---------	---------

RIVA (2104) Break

Tout / All / Alle / Tutti / Todos		05.1981	04.2012	LADA	2	48	10		X434003	X434004
-----------------------------------	--	---------	---------	------	---	----	----	--	---------	---------

RIVA (2105)

Tout / All / Alle / Tutti / Todos		05.1981	04.2012	LADA	2	48	10		X434003	X434004
-----------------------------------	--	---------	---------	------	---	----	----	--	---------	---------

SAGONA (21099)

Tout / All / Alle / Tutti / Todos		05.1989	12.2006	LADA	1	48	12		X434001	X434002
-----------------------------------	--	---------	---------	------	---	----	----	--	---------	---------

SAMARA (2108, 2109, 2113, 2114, 2115)

Tout / All / Alle / Tutti / Todos		01.1986	12.2013	LADA	1	48	12		X434001	X434002
-----------------------------------	--	---------	---------	------	---	----	----	--	---------	---------



LAMBORGHINI



COUNTACH

5.2 V12		01.1985	12.1991	ATE	4	40			X224587	X224588
---------	--	---------	---------	-----	---	----	--	--	---------	---------

DIABLO

5.7		01.1990		ATE	4	42			X224613	X224614
		01.1990		ATE	4	40			X225305	X225306

ESPADA

Tout / All / Alle / Tutti / Todos		01.1968	12.1970	GIRL-TRW	3	43/60			X374467	X374468
		01.1970		GIRL-TRW	3	43/60			X374513	X374514
		01.1970		GIRL-TRW	3	27/38			X375243	X375244

ISLERO

Tout / All / Alle / Tutti / Todos		01.1970		GIRL-TRW	3	43/60			X374513	X374514
		01.1970		GIRL-TRW	3	27/38			X375243	X375244

JARAMA

Tout / All / Alle / Tutti / Todos		01.1970		GIRL-TRW	3	43/60			X374513	X374514
		01.1970		GIRL-TRW	3	27/38			X375243	X375244

URRACO

P200		01.1975	12.1981	ATE	4	34			X225207	X225208
P250		01.1972	12.1981	ATE	4	34			X225207	X225208
P300		01.1974	12.1981	ATE	4	34			X225207	X225208



LANCIA



A 112

Tout / All / Alle / Tutti / Todos		07.1971	12.1976	BENDIX	1	48	10		X254033	X254034
		03.1978	12.1986	BENDIX	1	48	10		X254023	X254024

X=1 : SNRA - X=2 : EAI - X=3 : SERA - X=4 : SEEAC - X=5 : NEOTO - X=6 : STARTCAR

Affectations par Marques

Vehicule application - Zuordnung nach Marke und Fahrzeuge - Applicazione per marca e veicolo - Aplicacion por marca y vehiculo



LANCIA



BETA (828)

Tout / All / Alle / Tutti / Todos		01.1974	12.1985	BENDIX	1	45	12,7		X254051	X254052
		01.1974	12.1985	BENDIX	1	36	10		X255013	X255014

BETA MONTECARLO

Tout / All / Alle / Tutti / Todos		03.1975	12.1979	BENDIX	1	48	10		X254199	X254200
		03.1975	12.1979	BENDIX	1	38	10		X255035	X255036

DEDRA (835)

Tout / All / Alle / Tutti / Todos		04.1989	07.1999	ATE	1	54	20/Ø257	#ID: 531FN 532FN	X224283	X224284
		04.1989	07.1999	ATE	1	54	22/Ø284	#ID: 561FN 562FN	X224285	X224286
		04.1989	07.1999	GIRL-TRW	1	48	11	#ID: 792834 792836	X374277	X374278
		04.1989	07.1999	GIRL-TRW	1	48	12	#ID: 791365 791366	X374161	X374162
		04.1989	07.1999	GIRL-TRW	1	54	12		X374265	X374266
		04.1989	07.1999	GIRL-TRW	1	54	12		X374469	X374470
		04.1989	07.1999	GIRL-TRW	1	54	20/Ø257	#ID: 791559 791560	X374267	X374268
		04.1989	07.1999	GIRL-TRW	1	54	22/Ø284	#ID: 32322921 32322922	X374165	X374166
		04.1989	07.1999	GIRL-TRW	1	54	22/Ø284	#ID: 76320064	X374397	X374398
		04.1989	07.1999	BENDIX	1	34	11	Al	X255037	X255038
		04.1989	07.1999	GIRL-TRW	1	34	11	Fe #ID: 4753 4754	X375083	X375084
		04.1989	07.1999	GIRL-TRW	1	34	11	Fe #ID: 941 942	X375033	X375034
		04.1989	07.1999	GIRL-TRW	1	34	11	Al	X375289	X375290

DELTA I (831)

Tout / All / Alle / Tutti / Todos		08.1986	01.1994	BREMBO	4	38/44	26		X284025	X284026
		08.1986	01.1994	GIRL-TRW	1	48	12		X374161	X374162
		08.1986	01.1994	GIRL-TRW	1	48	20/Ø257		X374157	X374158
		08.1986	01.1994	GIRL-TRW	1	54	22/Ø284		X374165	X374166
		08.1986	01.1994	BENDIX	1	34	10.8		X255029	X255030
		08.1986	01.1994	GIRL-TRW	1	36	10		X375161	X375162

DELTA II (836)

Tout / All / Alle / Tutti / Todos		06.1993	09.1999	ATE	1	54	12		X224431	X224432
		06.1993	09.1999	ATE	1	54	20/Ø257	#ID: 531FN 532FN	X224283	X224284
		06.1993	09.1999	ATE	1	54	22/Ø284	#ID: 561FN 562FN	X224285	X224286
		06.1993	09.1999	GIRL-TRW	1	54	12		X374265	X374266
		06.1993	09.1999	GIRL-TRW	1	54	12		X374469	X374470
		06.1993	09.1999	GIRL-TRW	1	54	22		X374397	X374398
		06.1993	09.1999	GIRL-TRW	1	34	11	Fe #ID: 4753 4754	X375083	X375084
		06.1993	09.1999	GIRL-TRW	1	34	11	Fe #ID: 941 942	X375033	X375034
		06.1993	09.1999	GIRL-TRW	1	34	11	Al	X375289	X375290



DELTA III (844)

Tout / All / Alle / Tutti / Todos		08.2008	08.2014	ATE	1	57	28		X224851	X224852
		08.2008	08.2014	BOSCH	1	54	22/Ø284		X274033	X274034
		08.2008	08.2014	BOSCH	1	57	26/Ø281		X274035	X274036
		08.2008	08.2014	BOSCH	1	38	10		X275049	X275050

X=1 : SNRA - X=2 : EAI - X=3 : SERA - X=4 : SEEAC - X=5 : NEOTO - X=6 : STARTCAR

Affectations par Marques

Vehicule application - Zuordnung nach Marke und Fahrzeuge - Applicazione per marca e veicolo - Aplicacion por marca y vehiculo

     											
LANCIA											
KAPPA (838)											
Tout / All / Alle / Tutti / Todos		08.1994	10.2001	GIRL-TRW	1	54	22			X374633	X374634
		08.1994	10.2001	GIRL-TRW	1	38	10			X375145	X375146
		08.1994	10.2001	GIRL-TRW	1	38	10			X375173	X375174
LYBRA (839)											
Tout / All / Alle / Tutti / Todos		07.1999	10.2005	ATE	1	54	15			X224473	X224474
		07.1999	10.2005	ATE	1	54	22			X224285	X224286
		07.1999	10.2005	GIRL-TRW	1	38	10			X375247	X375248
MUSA (350)											
Tout / All / Alle / Tutti / Todos		10.2004	09.2012	BOSCH	1	54	22/Ø257			X274031	X274032
		10.2004	09.2012	BOSCH	1	54	22/Ø284			X274081	X274082
		10.2004	09.2012	GIRL-TRW	1	34	11			X375345	X375346
PHEDRA (179)											
Tout / All / Alle / Tutti / Todos		09.2002	11.2010	GIRL-TRW	1	60	28			X374589	X374590
		09.2002	11.2010	GIRL-TRW	2	40/45	32			X374699	X374700
		09.2002	11.2010	GIRL-TRW	1	38	12			X375291	X375292
PRISMA (831)											
Tout / All / Alle / Tutti / Todos		01.1983	12.1998	GIRL-TRW	1	48	12			X374161	X374162
		01.1983	12.1998	BENDIX	1	34	10,8			X255029	X255030
THEMA (834)											
Tout / All / Alle / Tutti / Todos		10.1984	07.1994	ATE	1	54	22			X224285	X224286
		10.1984	07.1994	GIRL-TRW	1	54	14			X374425	X374426
		10.1984	07.1994	GIRL-TRW	1	54	22			X374165	X374166
		10.1984	08.1988	BENDIX	1	36	10			X255031	X255032
		10.1984	08.1988	GIRL-TRW	1	36	10			X375035	X375036
		09.1988	07.1994	GIRL-TRW	1	38	10			X375045	X375046
THEISIS (841)											
Tout / All / Alle / Tutti / Todos		07.2002	07.2009	GIRL-TRW	1	60	28			X374645	X374646
		07.2002	07.2009	GIRL-TRW	1	38	22			X377035	X377036
Y (840)											
Tout / All / Alle / Tutti / Todos		11.1995	09.2003	ATE	1	48	12			X224533	X224534
		11.1995	09.2003	BENDIX	1	48	11			X254145	X254146
		11.1995	09.2003	GIRL-TRW	1	48	12			X374161	X374162
Y10 (156)											
Tout / All / Alle / Tutti / Todos		01.1985	12.1986	BENDIX	1	48	10,8		5257_	X254085	X254086
		01.1986	12.1995	BENDIX	1	48	10,8		5349_ / 5317_	X254093	X254094
		01.1986	12.1995	BENDIX	1	48	11			X254145	X254146
		01.1986	12.1995	GIRL-TRW	1	48	12			X374161	X374162

Affectations par Marques

Vehicule application - Zuordnung nach Marke und Fahrzeuge - Applicazione per marca e veicolo - Aplicacion por marca y vehiculo



LANCIA



YPSILON (843)

Tout / All / Alle / Tutti / Todos		10.2003	12.2011	BOSCH	1	54	22		X274031	X274032
		10.2003	12.2011	GIRL-TRW	1	48	12		X374637	X374638
		10.2003	12.2011	GIRL-TRW	1	54	22		X374639	X374640
		10.2003	12.2011	GIRL-TRW	1	34	11		X375345	X375346

YPSILON (846-312)

Tout / All / Alle / Tutti / Todos		05.2011		ATE	1	54	22		X224855	X224856
-----------------------------------	--	---------	--	-----	---	----	----	--	---------	---------

ZETA (220)

Tout / All / Alle / Tutti / Todos		05.1995	09.2002	BENDIX	1	57	20		X254207	X254208
		05.1995	09.2002	GIRL-TRW	1	57	26		X374293	X374294
		05.1995	09.2002	ATE	1	36	10		X225161	X225162



LAND ROVER



DEFENDER (LD_)

Tout / All / Alle / Tutti / Todos		09.1990	02.2016	LOCK	4	41	14		X464039	X464040
		09.1990	02.2016	LOCK	4	41	14		X464045	X464046
		09.1990	02.2016	LOCK	4	46	14		X464047	X464048
		09.1990	02.2016	LOCK	4	46	24		X464097	X464098
		09.1990	02.2016	LOCK	2	41	12,6		X465007	X465008
		09.1990	02.2016	LOCK	2	46	12,5		X465009	X465010
		09.1990	02.2016	LOCK	2	46	12,6		X465005	X465006

DEFENDER 110 (DHMC)

Tout / All / Alle / Tutti / Todos		09.1983	12.2001	LOCK	4	46	14		X464047	X464048
		09.1983	12.2001	LOCK	4	46	14		X464051	X464052
		09.1983	12.2001	LOCK	4	46	24		X464097	X464098
		09.1983	12.2001	LOCK	2	46	12,6		X465005	X465006

DEFENDER 90 (DHMC)

Tout / All / Alle / Tutti / Todos		09.1983	12.2001	LOCK	4	41	14		X464039	X464040
		09.1983	12.2001	LOCK	4	41	14		X464045	X464046
		09.1983	12.2001	LOCK	4	46	14		X464047	X464048
		09.1983	12.2001	LOCK	4	46	24		X464097	X464098
		09.1983	12.2001	LOCK	2	41	12,6		X465007	X465008

DISCOVERY I (LJ, LG)

2.0 16 V 4x4		09.1993	10.1998	LOCK	4	41	14		LA081992->	X464039	X464040
		09.1993	10.1998	LOCK	4	41	14,4		->LA081991	X464091	X464092
		09.1993	10.1998	LOCK	4	41	24			X464043	X464044
2.5 D 4x4		07.1994	10.1998	LOCK	4	41	14,4			X464091	X464092
		07.1994	10.1998	LOCK	4	41	24			X464043	X464044
2.5 TDI 4x4		10.1989	10.1998	LOCK	4	41	14,4			X464091	X464092
		10.1989	10.1998	LOCK	4	41	24			X464043	X464044
3.5 4x4		10.1989	06.1994	LOCK	4	41	14,4			X464091	X464092
		10.1989	06.1994	LOCK	4	41	24			X464043	X464044

X=1 : SNRA - X=2 : EAI - X=3 : SERA - X=4 : SEEAC - X=5 : NEOTO - X=6 : STARTCAR

Affectations par Marques

Vehicule application - Zuordnung nach Marke und Fahrzeuge - Applicazione per marca e veicolo - Aplicacion por marca y vehiculo



LAND ROVER

DISCOVERY I (LJ, LG)

3.5 4x4 (SALLJG)		10.1989	06.1994	LOCK	4	41	14,4		X464091	X464092	
		10.1989	06.1994	LOCK	4	41	24		X464043	X464044	
3.9 V8 4x4		09.1993	10.1998	LOCK	4	41	14,4		X464091	X464092	
		09.1993	10.1998	LOCK	4	41	24		X464043	X464044	
4.0 4x4		09.1995	10.1998	LOCK	4	41	14,4		X464091	X464092	
		09.1995	10.1998	LOCK	4	41	24		X464043	X464044	
Tout / All / Alle / Tutti / Todos		09.1993	06.1994	LOCK	2	41	12,6		11	X465001	X465002
		07.1994	10.1998	LOCK	2	41	12,6		12	X465007	X465008

DISCOVERY II (LJ, LT)

2.5 Td5		03.1999	11.2003	GIRL-TRW	2	48	25		X374439	X374440	
2.5 Td5 4x4		01.1999	06.2004	GIRL-TRW	2	45	25		3A000000->	X374647	X374648
		01.1999	06.2004	GIRL-TRW	2	48	25		->2A999999	X374439	X374440
4.0 i V8 4x4		11.1998	06.2004	GIRL-TRW	2	45	25		3A000000->	X374647	X374648
		11.1998	06.2004	GIRL-TRW	2	48	25		->2A999999	X374439	X374440
4.0 V8		11.1998	06.2004	GIRL-TRW	2	45	25		3A000000->	X374647	X374648
		11.1998	06.2004	GIRL-TRW	2	48	25		->2A999999	X374439	X374440
4.0 V8 4x4		11.1998	06.2004	GIRL-TRW	2	45	25		3A000000->	X374647	X374648
		11.1998	06.2004	GIRL-TRW	2	48	25		->2A999999	X374439	X374440
Tout / All / Alle / Tutti / Todos		11.1998	06.2004	GIRL-TRW	1	45	13			X375167	X375168

DISCOVERY III (TAA)

Tout / All / Alle / Tutti / Todos		07.2004	09.2009	GIRL-TRW	2	48	30		X374627	X374628
		07.2004	09.2009	GIRL-TRW	1	45	20		X375331	X375332

DISCOVERY IV (LA)

2.7 TD 4x4		09.2009		GIRL-TRW	2	48	10/Ø317 ~337		X374627	X374628
3.0 4x4		08.2013		GIRL-TRW	2	48	10/Ø317 ~337		X374627	X374628
		08.2013		GIRL-TRW	2	48	30/Ø360		X374763	X374764
3.0 SDV6 4x4		11.2009		GIRL-TRW	2	48	30/Ø360		X374763	X374764
3.0 TD 4x4		09.2009		GIRL-TRW	2	48	30/Ø360		X374763	X374764
5.0 V8 4x4		09.2009		GIRL-TRW	2	48	30/Ø360		X374763	X374764
Tout / All / Alle / Tutti / Todos		09.2009		GIRL-TRW	1	45	20		X375331	X375332

FREELANDER I (LN)

Tout / All / Alle / Tutti / Todos		02.1998	03.2007	GIRL-TRW	1	57	14		X374535	X374536
		02.1998	03.2007	GIRL-TRW	1	57	21		X374537	X374538

FREELANDER II (FA_)

Tout / All / Alle / Tutti / Todos		10.2006	10.2014	ATE	1	60	28		X224663	X224664
		10.2006	10.2014	GIRL-TRW	1	36	12		X375383	X375384
		10.2006	10.2014	GIRL-TRW	1	38	20		X375447	X375448

RANGE ROVER EVOQUE (LV)

Tout / All / Alle / Tutti / Todos		06.2011		ATE	1	60	28		X224663	X224664
		06.2011		GIRL-TRW	1	34	11		X377077	X377078

X=1 : SNRA - X=2 : EAI - X=3 : SERA - X=4 : SEEC - X=5 : NEOTO - X=6 : STARTCAR

Affectations par Marques

Vehicule application - Zuordnung nach Marke und Fahrzeuge - Applicazione per marca e veicolo - Aplicacion por marca y vehiculo



LAND ROVER

RANGE ROVER I (AE, AN, HAA, HAB, HAM, HBM, RE, RN)

Tout / All / Alle / Tutti / Todos		03.1970	01.1981	LOCK	4	41	14,2		X464061	X464062
		02.1981	08.1989	LOCK	4	41	14,2		X464035	X464036
		09.1989	04.1993	LOCK	4	41	24		X464099	X464100
		05.1993	12.1996	LOCK	4	41	24		X464043	X464044
		03.1970	04.1981	LOCK	2	41	12,6		X465003	X465004
		02.1981	04.1993	LOCK	2	41	12,6		X465001	X465002
		05.1993	12.1996	LOCK	2	41	12,6		X465007	X465008

RANGE ROVER II (LP)

Tout / All / Alle / Tutti / Todos		07.1994	08.2008	GIRL-TRW	2	48	25		X374439	X374440
		07.1994	08.2008	GIRL-TRW	1	45	13		X375167	X375168

RANGE ROVER III (LM)

3.0 TD 6 4x4		03.2002	08.2009	ATE	1	60	30		X224441	X224442
		03.2002	08.2009	GIRL-TRW	2	48	30		X374627	X374628
		03.2002	08.2009	ATE	1	42	12		X225359	X225360
		03.2002	08.2009	GIRL-TRW	1	45	20		X375331	X375332
3.6 TD 8 4x4		04.2006	08.2012	ATE	1	60	30		X224441	X224442
		04.2006	08.2012	GIRL-TRW	2	48	30		X374763	X374764
		04.2006	08.2012	ATE	1	42	12		X225359	X225360
4.2 4x4		05.2005	08.2012	ATE	1	60	30		X224441	X224442
		05.2005	08.2012	ATE	1	42	12		X225359	X225360
		05.2005	08.2012	GIRL-TRW	1	45	20		X375331	X375332
4.4 4x4		03.2002	12.2005	ATE	1	60	30		X224441	X224442
		05.2005	08.2012	GIRL-TRW	2	48	30		X374627	X374628
		03.2002	12.2005	ATE	1	42	12		X225359	X225360
		03.2002	12.2005	GIRL-TRW	1	45	20		X375331	X375332
4.4 TD V8 4x4		07.2010	08.2012	GIRL-TRW	1	45	20		X375463	X375464
5.0 V8 4x4		09.2009	08.2012	GIRL-TRW	2	48	30		X374763	X374764
		09.2009	08.2012	GIRL-TRW	1	45	20		X375463	X375464

RANGE ROVER IV (LG)

3.0 TD 4x4		08.2012		BREMBO	6	36/ 38/ 40	30		X284237	X284238
		08.2012		GIRL-TRW	2	48	30		X374763	X374764
4.4 TD V8 4x4		08.2012		BREMBO	6	36/ 38/ 40	30		X284237	X284238
5.0 V8 4x4		08.2012		BREMBO	6	36/ 38/ 40	30		X284237	X284238

RANGE ROVER SPORT I (LS)

2.7 TDVM 4x4		02.2005	09.2009	BREMBO	4	46	30		X284241	X284242
		02.2005	09.2009	GIRL-TRW	2	48	30		X374627	X374628
		02.2005	09.2009	GIRL-TRW	1	45	20		X375331	X375332
3.0 TD 4x4		09.2009	12.2012	GIRL-TRW	2	48	30		X374763	X374764
		09.2009	12.2012	GIRL-TRW	1	45	20		X375331	X375332
3.0 TD V6 4x4		05.2010	12.2012	GIRL-TRW	2	48	30		X374763	X374764
		05.2010	12.2012	GIRL-TRW	1	45	20		X375331	X375332

X=1 : SNRA - X=2 : EAI - X=3 : SERA - X=4 : SEEAC - X=5 : NEOTO - X=6 : STARTCAR

Affectations par Marques

Vehicule application - Zuordnung nach Marke und Fahrzeuge - Applicazione per marca e veicolo - Aplicacion por marca y vehiculo



LAND ROVER

RANGE ROVER SPORT I (LS)

3.6 TD 8 4x4		04.2006	12.2012	BREMBO	4	46	30		X284241	X284242
		04.2006	12.2012	GIRL-TRW	2	48	30		X374763	X374764
		04.2006	12.2012	GIRL-TRW	1	45	20		X375331	X375332
4.2 4x4		02.2005	12.2012	BREMBO	4	46	30		X284241	X284242
		02.2005	12.2012	GIRL-TRW	1	45	20		X375331	X375332
4.4 4x4		02.2005	12.2012	BREMBO	4	46	30		X284241	X284242
		02.2005	12.2012	GIRL-TRW	2	48	30		X374627	X374628
		02.2005	12.2012	GIRL-TRW	1	45	20		X375331	X375332
5.0 V8 4x4		04.2009	12.2012	GIRL-TRW	2	48	30		X374763	X374764
		04.2009	12.2012	GIRL-TRW	1	45	20		X375463	X375464
		07.2009	12.2012	GIRL-TRW	1	45	20		X375331	X375332

RANGE ROVER SPORT II (LW)

3.0 4x4		04.2013		GIRL-TRW	2	48	30		X374763	X374764
3.0 TD 4x4		04.2013		GIRL-TRW	2	48	30		X374763	X374764
5.0 V8 4x4		04.2013		BREMBO	6	36/ 38/ 40	30		X284237	X284238

LDV Limited

200

Tout / All / Alle / Tutti / Todos		04.1989	03.1996	LOCK	4	41	14,4		X464089	X464090
-----------------------------------	--	---------	---------	------	---	----	------	--	---------	---------

400

Tout / All / Alle / Tutti / Todos		04.1989	10.1998	LOCK	4	41	14,4		X464089	X464090
		04.1989	10.1998	LOCK	4	46	24		X464059	X464060

CONVOY

Tout / All / Alle / Tutti / Todos		04.1996	11.2006	LOCK	4	41	14,4		X464089	X464090
		04.1996	11.2006	LOCK	4	46	24		X464059	X464060

PILOT

Tout / All / Alle / Tutti / Todos		04.1996	10.2005	LOCK	4	41	14,4		X464089	X464090
-----------------------------------	--	---------	---------	------	---	----	------	--	---------	---------

SHERPA

Tout / All / Alle / Tutti / Todos		06.1974	03.1989	LOCK	2	57	14,3		X464067	X464068
		06.1974	03.1989	LOCK	4	41	14,4		X464089	X464090

LEXUS

CT (ZWA1_)

Tout / All / Alle / Tutti / Todos		12.2010	12.2013	SUMITOMO	1	57	25		X644187	X644188
-----------------------------------	--	---------	---------	----------	---	----	----	--	---------	---------

ES (F1, F2)

300		09.1991	12.1997	AKE	2	43	28		X164211	X164212
		09.1991	12.1997	AISIN	1	35	10		X135003	X135004
		09.1991	12.1997	AISIN	1	40	16		X135009	X135010

GS I (JZS147)

300		03.1993	08.1997	AISIN	2	45	32		X134035	X134036
		03.1993	08.1997	AISIN	1	43	16		X135015	X135016

X=1 : SNRA - X=2 : EAI - X=3 : SERA - X=4 : SEEC - X=5 : NEOTO - X=6 : STARTCAR

Affectations par Marques

Vehicule application - Zuordnung nach Marke und Fahrzeuge - Applicazione per marca e veicolo - Aplicacion por marca y vehiculo



LEXUS

GS II (UZS161, JZS160)

300		08.1997	12.2004	AISIN	2	45	32		X134035	X134036
		08.1997	12.2004	AISIN	2	40	12		X135019	X135020

GS III (GRS19_, UZS19_, URS19_, GWS19_)

Tout / All / Alle / Tutti / Todos		04.2005	11.2011	ADVICS	4	43	30		X114007	X114008
-----------------------------------	--	---------	---------	--------	---	----	----	--	---------	---------

GS IV (GRL1_, GWL1_)

Tout / All / Alle / Tutti / Todos		01.2012		ADVICS	4	43	30		X114007	X114008
-----------------------------------	--	---------	--	--------	---	----	----	--	---------	---------

GX I (_J12_)

Tout / All / Alle / Tutti / Todos		11.2001	11.2009	SUMITOMO	4	45	18		X644163	X644164
		11.2001	11.2009	SUMITOMO	1	48	18		X645031	X645032

GX II (URJ15_)

Tout / All / Alle / Tutti / Todos		11.2009		SUMITOMO	4	48	32		X644219	X644220
		11.2009		SUMITOMO	1	48	18		X645031	X645032

IS I (JCE1_, GXE1_)

Tout / All / Alle / Tutti / Todos		04.1999	07.2005	AISIN	2	45	32		X134061	X134062
		04.1999	07.2005	AISIN	2	40	12		X135019	X135020

IS II (GSE2_, ALE2_, USE2_)

Tout / All / Alle / Tutti / Todos		10.2005	12.2013	ADVICS	1	60	28		X114017	X114018
		10.2005	12.2013	ADVICS	1	43	10		X115005	X115006

IS III (GSE3_, AVE3_)

Tout / All / Alle / Tutti / Todos		04.2013		ADVICS	1	60	28		X114017	X114018
-----------------------------------	--	---------	--	--------	---	----	----	--	---------	---------

IS SportCross

Tout / All / Alle / Tutti / Todos		10.2001		AISIN	2	45	32		X134061	X134062
		10.2001		AISIN	2	40	12		X135019	X135020

LS (UCF10)

400		12.1989	08.1992	AISIN	2	45	28		X134039	X134040
		09.1992	12.1994	AISIN	2	45	32		X134033	X134034
		12.1989	08.1992	AISIN	1	43	16		X135011	X135012
		09.1992	12.1994	AISIN	1	43	16		X135013	X135014

LS (UCF20)

400		12.1994	10.2000	SUMITOMO	4	43	28		X644129	X644130
		12.1994	10.2000	AISIN	1	38	16		X135017	X135018

LS (UCF30)

430		10.2000	12.2006	SUMITOMO	4	43	30		X644189	X644190
		10.2000	12.2006	SUMITOMO	2	43	16		X645037	X645038

LS (UCF40)

460		12.2006		SUMITOMO	4	43	30		X644189	X644190
-----	--	---------	--	----------	---	----	----	--	---------	---------

LX I (UZJ100)

470		09.2001	03.2008	SUMITOMO	1	48	18		X645015	X645016
		09.2001	03.2008	SUMITOMO	1	48	18		X645033	X645034

X=1 : SNRA - X=2 : EAI - X=3 : SERA - X=4 : SEEAC - X=5 : NEOTO - X=6 : STARTCAR

Affectations par Marques

Vehicule application - Zuordnung nach Marke und Fahrzeuge - Applicazione per marca e veicolo - Aplicacion por marca y vehiculo



LEXUS

LX I (UZJ100)

Tout / All / Alle / Tutti / Todos		09.2001	03.2008	SUMITOMO	4	45/51	32		X644153	X644154
-----------------------------------	--	---------	---------	----------	---	-------	----	--	---------	---------

LX II (URJ201)

Tout / All / Alle / Tutti / Todos		11.2007		SUMITOMO	4	51	32		X644205	X644206
		11.2007		SUMITOMO	1	45	18		X645047	X645048

NX (ZGZ1_, AGZ1_, AYZ1_)

Tout / All / Alle / Tutti / Todos		09.2014		AKE	2	45	28		X164327	X164328
-----------------------------------	--	---------	--	-----	---	----	----	--	---------	---------

RC (AVC1_, GSC1_, USC1_)

Tout / All / Alle / Tutti / Todos		08.2014		ADVICS	4	43	30		X114007	X114008
-----------------------------------	--	---------	--	--------	---	----	----	--	---------	---------

RX I (MCU15)

3.0		07.2000	05.2003	AKE	1	60	28		X164309	X164310
		07.2000	05.2003	AISIN	1	40	10		X135027	X135028

RX II (MHU3_, GSU3_, MCU3_)

Tout / All / Alle / Tutti / Todos		04.2003	12.2008	AKE	1	63,5	28		X164307	X164308
		04.2003	12.2008	AKE	1	38	10		X165201	X165202

RX III (GYL1_, GGL15, AGL10)

3.5		12.2008		AKE	2	45	28		X164327	X164328
-----	--	---------	--	-----	---	----	----	--	---------	---------

SC (UZZ40_)

4.3		05.2001	08.2010	AISIN	2	45	32		X134035	X134036
		05.2001	08.2010	AISIN	2	40	12		X135019	X135020



LEYLAND



SHERPA 280

Tout / All / Alle / Tutti / Todos		01.1982	12.1989	LOCK	4	41	14,4		X464093	X464094
-----------------------------------	--	---------	---------	------	---	----	------	--	---------	---------

SHERPA 285-310-350

Tout / All / Alle / Tutti / Todos		01.1982	12.1985	LOCK	4	41	14,4	>1375KG	X464093	X464094
		01.1985	12.1996	LOCK	4	46	14,4		X464115	X464116



LOTUS



ELAN

1.6i 16V		09.1989	11.1995	DELCO	1	52	24		X104029	X104030
		09.1989	11.1995	K/H	1	35			X795005	X795006
1.6i 16V TURBO		09.1989	11.1995	DELCO	1	52	24		X104029	X104030
		09.1989	11.1995	K/H	1	35			X795005	X795006
1600		01.1962	12.1964	GIRL-TRW	2	43			X374307	X374308
		01.1962	12.1964	GIRL-TRW	2	34			X375209	X375210
GT		01.1964	12.1965	GIRL-TRW	2	48			X374477	X374478
		01.1964	12.1965	GIRL-TRW	2	34			X375209	X375210
S2		01.1964	12.1969	GIRL-TRW	2	48			X374477	X374478
		01.1964	12.1969	GIRL-TRW	2	34			X375209	X375210

X=1 : SNRA - X=2 : EAI - X=3 : SERA - X=4 : SEEAC - X=5 : NEOTO - X=6 : STARTCAR

Affectations par Marques

Vehicule application - Zuordnung nach Marke und Fahrzeuge - Applicazione per marca e veicolo - Aplicacion por marca y vehiculo



LOTUS



ELAN

S3		01.1966	12.1969	GIRL-TRW	2	48			X374477	X374478
		01.1966	12.1969	GIRL-TRW	2	34			X375209	X375210
S4		01.1966	12.1969	GIRL-TRW	2	48			X374477	X374478
		01.1966	12.1969	GIRL-TRW	2	34			X375209	X375210

ESPRIT S2

S2		01.1975		BENDIX	1	45			X255071	X255072
		01.1975		GIRL-TRW	1				X375201	X375202



MASERATI



3500 GT

3500 GT		01.1961	12.1965	GIRL-TRW	3	43/60			X374467	X374468
		01.1961	12.1965	GIRL-TRW	3	34/48			X375207	X375208

5000 GT

5000 GT		01.1961	12.1965	GIRL-TRW	3	43/60			X374467	X374468
		01.1961	12.1965	GIRL-TRW	3	34/48			X375207	X375208

BITURBO 2000

2000		01.1982		ATE	2	33			X225205	X225206
------	--	---------	--	-----	---	----	--	--	---------	---------

BORA

4.7		01.1971	05.1980	GIRL-TRW	4	34/43			X374611	X374612
		01.1971	05.1980	GIRL-TRW	3	34/48			X375311	X375312
5.0		07.1976	05.1980	GIRL-TRW	4	34/43			X374611	X374612
		07.1976	05.1980	GIRL-TRW	3	34/48			X375311	X375312

CHRYSLER TC

2.2				ATE	1	33			X225243	X225244
3.0 V6				ATE	1	33			X225243	X225244

GIBLI

Tout / All / Alle / Tutti / Todos		02.1968		GIRL-TRW	3	43/60			X374467	X374468
		02.1968		GIRL-TRW	3	30/43			X375263	X375264

MERAK LHM

Tout / All / Alle / Tutti / Todos		12.1972		GIRL-TRW	4	34/43			X374611	X374612
		12.1972		CITROEN	2	50			X315025	X315026

MEXICO

Tout / All / Alle / Tutti / Todos		02.1968		GIRL-TRW	3	43/60			X374513	X374514
		02.1968		GIRL-TRW	3	30/43			X375263	X375264

MISTRALE

Tout / All / Alle / Tutti / Todos		01.1965	01.1968	GIRL-TRW	3	43/60			X374467	X374468
		02.1968		GIRL-TRW	3	43/60			X374513	X374514
		01.1965	01.1968	GIRL-TRW	3	30/43			X375335	X375336
		02.1968		GIRL-TRW	3	30/43			X375263	X375264

Affectations par Marques

Vehicule application - Zuordnung nach Marke und Fahrzeuge - Applicazione per marca e veicolo - Aplicacion por marca y vehiculo



MASERATI



QUATTROPORTE

Tout / All / Alle / Tutti / Todos		02.1968		GIRL-TRW	3	43/60				X374513	X374514
		02.1968		GIRL-TRW	3	30/43				X375263	X375264



MAZDA



2 I (DY)

Tout / All / Alle / Tutti / Todos		02.2003	09.2007	ATE	1	54	22/Ø258	ABS		X224573	X224574
-----------------------------------	--	---------	---------	-----	---	----	---------	-----	--	---------	---------

2 II (DE)

Tout / All / Alle / Tutti / Todos		10.2007	06.2015	MAZDA	1	54	23			X494005	X494006
-----------------------------------	--	---------	---------	-------	---	----	----	--	--	---------	---------

3 I (BK)

1.4		10.2003	03.2006	ATE	1	57	25/Ø278 -300			X224601	X224602
1.6		10.2003	06.2009	ATE	1	57	25/Ø278 -300			X224601	X224602
1.6 DI Turbo		06.2004	01.2009	ATE	1	57	25/Ø278 -300			X224601	X224602
1.6 MZ-CD		06.2006	01.2009	ATE	1	57	25/Ø278 -300			X224601	X224602
2.0		10.2003	06.2009	ATE	1	57	25/Ø278 -300			X224601	X224602
2.0 MZR-CD		12.2006	06.2009	ATE	1	57	25/Ø278 -300			X224601	X224602
2.3 MPS		12.2006	06.2009	ATE	1	57	25/Ø320			X224683	X224684
2.3 MZR Sport		10.2003	06.2009	ATE	1	57	25/Ø278 -300			X224601	X224602
		10.2003	06.2009	ATE	1	57	25/Ø320			X224683	X224684
Tout / All / Alle / Tutti / Todos		10.2003	06.2009	ATE	1	38	11			X225281	X225282

3 II (BL)

2.3 MPS Turbo		06.2009	09.2014	ATE	1	57	25/Ø320			X224683	X224684
Tout / All / Alle / Tutti / Todos		06.2009	09.2014	ATE	1	57	25/Ø278 -300			X224601	X224602
		06.2009	09.2014	ATE	1	38	11			X225445	X225446

5 I (CR19)

Tout / All / Alle / Tutti / Todos		03.2005		ATE	1	57	25			X224601	X224602
		03.2005		ATE	1	38	11			X225349	X225350

5 II (CW)

Tout / All / Alle / Tutti / Todos		09.2010		ATE	1	57	25			X224601	X224602
		09.2010		ATE	1	38	11			X225441	X225442

6 I (GG, GY)

Tout / All / Alle / Tutti / Todos		06.2002	08.2007	ATE	1	57	25			X224763	X224764
		06.2002	08.2007	SHI	1	57	24/Ø273			X634005	X634006
		06.2002	08.2007	SHI	1	57	25/Ø283			X634003	X634004
		06.2002	08.2007	AKE	1	35	10			X165159	X165160

6 II (GH)

Tout / All / Alle / Tutti / Todos		08.2007	09.2013	MAZDA	1	57	25			X494003	X494004
		08.2007	09.2013	AKE	1	35	10			X165159	X165160

6 III (GJ, GL)

Tout / All / Alle / Tutti / Todos		10.2012		MAZDA	1	57	28			X494007	X494008
		10.2012		AKE	1	38	10			X165207	X165208

X=1 : SNRA - X=2 : EAI - X=3 : SERA - X=4 : SEEAC - X=5 : NEOTO - X=6 : STARTCAR

Affectations par Marques

Vehicule application - Zuordnung nach Marke und Fahrzeuge - Applicazione per marca e veicolo - Aplicacion por marca y vehiculo



MAZDA



121 I (DA)

Tout / All / Alle / Tutti / Todos		10.1987	10.1990	SUMITOMO	1	48	13		X644065	X644066
-----------------------------------	--	---------	---------	----------	---	----	----	--	---------	---------

121 II (DB)

Tout / All / Alle / Tutti / Todos		11.1990	03.1996	SUMITOMO	1	51	13		X644067	X644068
-----------------------------------	--	---------	---------	----------	---	----	----	--	---------	---------

121 III (JASM, JBSM)

Tout / All / Alle / Tutti / Todos		03.1996	03.2003	ATE	1	48	10		X224215	X224216
		03.1996	03.2003	ATE	1	54	22/Ø240		X224477	X224478
		03.1996	03.2003	ATE	1	54	22/Ø258		X224573	X224574

323 I (FA)

Tout / All / Alle / Tutti / Todos		01.1977	01.1986	AKE	1	51	13		X164031	X164032
-----------------------------------	--	---------	---------	-----	---	----	----	--	---------	---------

323 II (BD)

Tout / All / Alle / Tutti / Todos		11.1980	05.1985	SUMITOMO	1	54	11		X644025	X644026
-----------------------------------	--	---------	---------	----------	---	----	----	--	---------	---------

323 III (BF, BW)

Tout / All / Alle / Tutti / Todos		08.1985	12.1989	SUMITOMO	1	51	18		X644011	X644012
		08.1985	12.1989	AKE	1	30	10		X165005	X165006

323 IV C, F, S (BG)

1.8 16V Turbo 4WD		06.1989	05.1995	AKE	1	57			X164263	X164264
		01.1993	07.1994	AKE	1	35	10		X165139	X165140
Tout / All / Alle / Tutti / Todos		06.1989	05.1995	SUMITOMO	1	54	18	#ID: 13-18V	X644059	X644060
		06.1989	05.1995	SUMITOMO	1	54	22	#ID: 13-22V	X644091	X644092
		06.1989	05.1995	SUMITOMO	1	54	22	#ID: 14-22V	X644071	X644072
		09.1989	12.1993	NAB	1	30	9		X525007	X525008

323 V C, F, P, S (BA)

Tout / All / Alle / Tutti / Todos		07.1994	09.1998	SUMITOMO	1	54	22	#ID: 13-22V	X644091	X644092
		07.1994	09.1998	SUMITOMO	1	54	22	#ID: 14-22V	X644071	X644072
		07.1994	09.1998	SUMITOMO	1	57	22	#ID: F17Z	X644135	X644136
		08.1994	09.1998	SUMITOMO	1	54	18	#ID: 13-18V	X644059	X644060
		07.1994	09.1998	NAB	1	30	9		X525017	X525018

323 VI F, S (BJ)

Tout / All / Alle / Tutti / Todos		09.1998	05.2004	SHI	1	57	24/Ø258		X634001	X634002
		09.1998	05.2004	SHI	1	57	24/Ø274		X634007	X634008
		09.1998	05.2004	SUMITOMO	1	54	22	#ID: 14-22V	X644071	X644072
		09.1998	05.2004	SUMITOMO	1	54	22	FSX16C	X644159	X644160
		05.1998	05.2004	AKE	1	35	10		X165137	X165138

626 I (CB)

Tout / All / Alle / Tutti / Todos		05.1979	12.1982	SUMITOMO	1	54	13		X644007	X644008
-----------------------------------	--	---------	---------	----------	---	----	----	--	---------	---------

626 II (GC)

Tout / All / Alle / Tutti / Todos		11.1982	10.1987	AKE	1	54	14		X164087	X164088
		11.1982	10.1987	AKE	1	54	20	#ID: 2123-2124	X164019	X164020
		11.1982	10.1987	AKE	1	54	20	#ID: 2149-2150	X164025	X164026
		11.1982	10.1987	AKE	1	35	10,3		X165025	X165026

X=1 : SNRA - X=2 : EAI - X=3 : SERA - X=4 : SEEAC - X=5 : NEOTO - X=6 : STARTCAR

Affectations par Marques

Vehicule application - Zuordnung nach Marke und Fahrzeuge - Applicazione per marca e veicolo - Aplicacion por marca y vehiculo



MAZDA



626 III (GD)

Tout / All / Alle / Tutti / Todos		01.1986	12.1991	AKE	1	54	20/Ø242		X164119	X164120
		01.1986	12.1991	AKE	1	54	24/Ø263		X164089	X164090
		01.1986	12.1991	AKE	1	30	10	2WD	X165007	X165008
		01.1986	12.1991	AKE	1	30	10	4WD	X165043	X165044

626 III (GV) SW

Tout / All / Alle / Tutti / Todos		01.1987	09.1997	AKE	1	54	24		X164089	X164090
		01.1987	09.1997	AKE	1	30	10		X165007	X165008
		01.1987	09.1997	AKE	1	42	18		X165115	X165116

626 IV (GE)

Tout / All / Alle / Tutti / Todos		08.1991	04.1997	SHI	1	57	24		X634001	X634002
		08.1991	04.1997	AKE	1	35	10	4WD	X165129	X165130
		08.1991	04.1997	NAB	1	30	10	2WD	X525009	X525010

626 V (GF)

Tout / All / Alle / Tutti / Todos		05.1997	10.2002	SHI	1	57	24		X634001	X634002
		05.1997	10.2002	AKE	1	35	10		X165137	X165138

626 V (GW) SW

Tout / All / Alle / Tutti / Todos		02.1998	10.2002	SHI	1	57	24/Ø258		X634001	X634002
		02.1998	10.2002	SHI	1	57	24/Ø274		X634007	X634008
		02.1998	10.2002	AKE	1	35	10		X165137	X165138

929 I (LA)

Tout / All / Alle / Tutti / Todos		01.1973	12.1986	AKE	1	54	18		X164123	X164124
-----------------------------------	--	---------	---------	-----	---	----	----	--	---------	---------

929 II (HB)

Tout / All / Alle / Tutti / Todos		05.1982	12.1986	AKE	1	54	20		X164027	X164028
		05.1982	12.1986	AKE	1	35	10		X165011	X165012

929 III (HC)

Tout / All / Alle / Tutti / Todos		12.1986	04.1992	SUMITOMO	1	54	12		X644001	X644002
		12.1986	04.1992	AKE	1	38	10,2		X165001	X165002
		12.1986	04.1992	AKE	1	38	18		X165107	X165108

B-SERIE (PE)

Tout / All / Alle / Tutti / Todos		02.1977	09.1981	AKE	1	54	12		X164143	X164144
-----------------------------------	--	---------	---------	-----	---	----	----	--	---------	---------

B-SERIE (UD)

Tout / All / Alle / Tutti / Todos		12.1965	10.1981	AKE	1	54	12		X164005	X164006
-----------------------------------	--	---------	---------	-----	---	----	----	--	---------	---------

B-SERIE (UF)

Tout / All / Alle / Tutti / Todos		01.1985	06.1999	AKE	1	54	20		X164033	X164034
		01.1985	06.1999	AKE	1	54	22		X164203	X164204
		01.1985	06.1999	AKE	1	60	22		X164295	X164296
		01.1985	06.1999	AKE	2	43	28		X164291	X164292











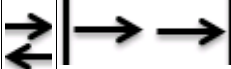





















B-SERIE (UN)

Tout / All / Alle / Tutti / Todos		02.1999	11.2006	PBR	1	^{60,32}	24		X594003	X594004
		02.1999	11.2006	TOKICO	2	43	26		X674079	X674080

X=1 : SNRA - X=2 : EAI - X=3 : SERA - X=4 : SEEC - X=5 : NEOTO - X=6 : STARTCAR

Affectations par Marques

Vehicule application - Zuordnung nach Marke und Fahrzeuge - Applicazione per marca e veicolo - Aplicacion por marca y vehiculo

        										
MAZDA										
BT-50 (CD, UN) Pick-up										
Tout / All / Alle / Tutti / Todos		12.2006	06.2013	PBR	1	60,32	24		X594003	X594004
		12.2006	06.2013	TOKICO	2	43	26		X674079	X674080
CX-7 (ER)										
Tout / All / Alle / Tutti / Todos		06.2006	12.2014	ADVICS	2	45	28		X114003	X114004
		06.2006	12.2014	MAZDA	1	43	18		X495001	X495002
CX-9 (TB)										
Tout / All / Alle / Tutti / Todos		01.2007		ADVICS	2	45	28		X114003	X114004
		01.2007		MAZDA	1	43	18		X495001	X495002
DEMIO (DW)										
Tout / All / Alle / Tutti / Todos		01.1996	07.2003	KPW	1	51	22		X414005	X414006
E-SERIE (SD1, SL)										
Tout / All / Alle / Tutti / Todos		10.1989	07.1999	SUMITOMO	1	60	20	#ID: 18BC	X644047	X644048
		10.1989	07.1999	SUMITOMO	1	60	20		X644223	X644224
		09.1999	07.2004	SUMITOMO	2	43	28		X644207	X644208
E-SERIE (SR2)										
E2000		06.1994	05.2003	SUMITOMO	1	60	20	#ID: 18BC	X644047	X644048
		06.1994	05.2003	SUMITOMO	1	60	20		X644223	X644224
E2000 4WD		04.1997	08.1999	SUMITOMO	1	60	20		X644221	X644222
E2200 D		03.1991	05.2003	SUMITOMO	1	60	20		X644221	X644222
		02.1997	08.1999	SUMITOMO	1	60	20		X644223	X644224
		02.1997	08.2002	SUMITOMO	2	43	28		X644207	X644208
E2200 D 4WD		02.1997	05.2003	SUMITOMO	1	60	20		X644221	X644222
MPV I (LV)										
Tout / All / Alle / Tutti / Todos		03.1995	09.1999	SUMITOMO	2	43			X644165	X644166
MPV II (LW)										
Tout / All / Alle / Tutti / Todos		09.1999	02.2006	SUMITOMO	2	43	28		X644227	X644228
MX-3 (EC)										
Tout / All / Alle / Tutti / Todos		07.1991	05.1998	SUMITOMO	1	54	22		X644071	X644072
		07.1991	05.1998	AKE	1	30	9		X165111	X165112
MX-5 I (NA)										
Tout / All / Alle / Tutti / Todos		05.1990	01.1994	SUMITOMO	1	51	18/Ø235		X644117	X644118
		08.1993	04.1998	SUMITOMO	1	51	20/Ø255		X644075	X644076
		05.1990	01.1994	NAB	1	32	9/Ø230		X525011	X525012
		08.1993	04.1998	NAB	1	32	9/Ø251		X525015	X525016

Affectations par Marques

Vehicule application - Zuordnung nach Marke und Fahrzeuge - Applicazione per marca e veicolo - Aplicacion por marca y vehiculo



MAZDA



MX-5 II (NB)

Tout / All / Alle / Tutti / Todos		01.1998	10.2005	SUMITOMO	1	51	18/Ø235		X644117	X644118
		01.1998	10.2005	SUMITOMO	1	51	20/Ø255		X644075	X644076
		01.1998	10.2005	SUMITOMO	1	54	22/Ø270		X644183	X644184
		01.1998	10.2005	NAB	1	32	9/Ø230		X525011	X525012
		01.1998	10.2005	NAB	1	32	9/Ø251		X525015	X525016
		01.1998	10.2005	NAB	1	35	10/Ø276		X525021	X525022

MX-5 III (NC)

Tout / All / Alle / Tutti / Todos		03.2005	12.2014	SUMITOMO	1	54	22		X644185	X644186
		03.2005	12.2014	NISSIN	1	38	10		X585041	X585042

MX-6 (GE)

Tout / All / Alle / Tutti / Todos		02.1992		SHI	1	57	24/Ø258		X634001	X634002
		02.1992		NAB	1	30	10		X525009	X525010

PREMACY (CP)

Tout / All / Alle / Tutti / Todos		07.1999	03.2005	SHI	1	57	24/Ø258		X634001	X634002
		07.1999	03.2005	SHI	1	57	24/Ø274		X634007	X634008
		07.1999	03.2005	AKE	1	35	10		X165137	X165138

RX 7 I (SA)

Wankel		05.1979	08.1985	AKE	1	51	18/Ø227		X164093	X164094
		05.1979	08.1985	AKE	1	51	22/Ø250 -276		X164095	X164096
		05.1979	03.1984	AKE	1	36	10		X165027	X165028
		01.1981	08.1985	AKE	1	35	20		X165029	X165030

RX 7 II (FC)

Tout / All / Alle / Tutti / Todos		11.1985	12.1991	SUMITOMO	4	36	22		X644069	X644070
		11.1985	12.1991	AKE	1	35	20		X165031	X165032

RX 7 III (FD)

Tout / All / Alle / Tutti / Todos		07.1992	08.2002	SUMITOMO	4	36	22		X644111	X644112
		07.1992	08.2002	AKE	1	35	20		X165113	X165114

RX 8 (SE, FE)

Tout / All / Alle / Tutti / Todos		10.2003	06.2012	SUMITOMO	1	54	24		X644209	X644210
		10.2003	06.2012	TOKICO	1	43	18		X675043	X675044

TRIBUTE (EP)

Tout / All / Alle / Tutti / Todos		03.2000	05.2008	ATE	1	60	24/Ø278		X224793	X224794
		03.2000	05.2008	ATE	1	66	24/Ø303		X224743	X224744
		03.2000	05.2008	ATE	1	40	11		X225371	X225372

XEDOS 6 (CA)

Tout / All / Alle / Tutti / Todos		01.1992	10.1999	SHI	1	57	24/Ø258		X634001	X634002
		01.1992	10.1999	NAB	1	30	10		X525009	X525010

XEDOS 9 (TA)

Tout / All / Alle / Tutti / Todos		07.1993	09.2002	AKE	2	43	28		X164233	X164234
		07.1993	09.2002	AKE	1	35	10		X165109	X165110

X=1 : SNRA - X=2 : EAI - X=3 : SERA - X=4 : SEEAC - X=5 : NEOTO - X=6 : STARTCAR

Affectations par Marques

Vehicule application - Zuordnung nach Marke und Fahrzeuge - Applicazione per marca e veicolo - Aplicacion por marca y vehiculo



MERCEDES-BENZ

CABRIOLET (A124)

Tout / All / Alle / Tutti / Todos		04.1992	06.1993	ATE	4	38/42	22		X224223	X224224
		04.1992	06.1993	ATE	2	38	9		X225191	X225192

CABRIOLET (W111)

280 SE 3.5 (111.025)		01.1969	12.1971	ATE	2	57	19		X224317	X224318
		01.1969	12.1971	ATE	2	35	10		X225027	X225028

CLA (C117)

CLA 180 (117.342)		01.2013		GIRL-TRW	1	60	28	V. SPORT	X374753	X374754
		01.2013		GIRL-TRW	1	60	28		X374751	X374752
CLA 180 CDI (117.312)		10.2013		GIRL-TRW	1	60	28	V. SPORT	X374753	X374754
		10.2013		GIRL-TRW	1	60	28		X374751	X374752
CLA 200 (117.343)		01.2013		GIRL-TRW	1	60	28	V. SPORT	X374753	X374754
		01.2013		GIRL-TRW	1	60	28		X374751	X374752
CLA 200 CDI (117.301)		06.2013		GIRL-TRW	1	60	28	V. SPORT	X374753	X374754
		06.2013		GIRL-TRW	1	60	28		X374751	X374752
CLA 220 CDI (117.303)		01.2013		GIRL-TRW	1	60	28		X374751	X374752
CLA 220 CDI (177.303)		01.2013		GIRL-TRW	1	60	28		X374751	X374752
Tout / All / Alle / Tutti / Todos		01.2013		GIRL-TRW	1	34	9/Ø276		X377059	X377060

CLASSE A (W168)

A 140 (168.031, 168.131)		07.1997	08.2004	GIRL-TRW	1	54	12		X374431	X374432
		07.1997	08.2004	GIRL-TRW	1	54	22		X374433	X374434
A 160 (168.033, 168.133)		07.1997	08.2004	GIRL-TRW	1	54	22		X374433	X374434
A 160 CDI (168.006)		02.2001	08.2004	GIRL-TRW	1	54	12		X374431	X374432
A 160 CDI (168.007)		07.1998	02.2001	GIRL-TRW	1	54	12		X374431	X374432
A 170 CDI (168.008)		07.1998	02.2001	GIRL-TRW	1	54	22		X374433	X374434
A 170 CDI (168.009, 168.109)		02.2001	08.2004	GIRL-TRW	1	54	22		X374433	X374434
A 190 (168.032, 168.132)		03.1999	08.2004	GIRL-TRW	1	57	22		X374569	X374570
Tout / All / Alle / Tutti / Todos		07.1997	08.2004	GIRL-TRW	1	28	8		X375351	X375352

CLASSE A (W169)

A 150 (169.031, 169.331)		09.2004	06.2012	GIRL-TRW	1	57	12		X374669	X374670
A 160 (169.031, 169.331)		04.2009	06.2012	GIRL-TRW	1	57	12		X374669	X374670
A 160 CDI (169.006, 169.306)		09.2004	08.2005	GIRL-TRW	1	57	12		X374669	X374670
		09.2004	06.2012	GIRL-TRW	1	57	22/Ø276		X374653	X374654
A 170 (169.032, 169.332)		09.2004	06.2012	GIRL-TRW	1	57	22/Ø276		X374653	X374654
A 180 (169.032, 169.332)		04.2009	06.2012	GIRL-TRW	1	57	22/Ø276		X374653	X374654
A 180 CDI (169.007, 169.307)		09.2004	06.2012	GIRL-TRW	1	57	22/Ø276		X374653	X374654
A 200 (169.033, 169.333)		09.2004	04.2007	GIRL-TRW	1	57	22/Ø276		X374653	X374654
A 200 CDI (169.008, 169.308)		09.2004	06.2012	GIRL-TRW	1	57	25/Ø288		X374657	X374658
A 200 CDI (169.308)		09.2004	06.2012	GIRL-TRW	1	57	25/Ø288		X374657	X374658
A 200 TURBO (169.034, 169.334)		09.2005	06.2012	GIRL-TRW	1	57	25/Ø288		X374657	X374658
Tout / All / Alle / Tutti / Todos		09.2004	06.2012	GIRL-TRW	1	30	8		X375381	X375382

X=1 : SNRA - X=2 : EAI - X=3 : SERA - X=4 : SEEAC - X=5 : NEOTO - X=6 : STARTCAR

Affectations par Marques

Vehicule application - Zuordnung nach Marke und Fahrzeuge - Applicazione per marca e veicolo - Aplicacion por marca y vehiculo



MERCEDES-BENZ

CLASSE A (W176)

A 160 CDI (176.011)		06.2013		GIRL-TRW	1	60	25/Ø288		X374749	X374750
		06.2013		GIRL-TRW	1	60	28	V. SPORT	X374753	X374754
A 180 (176.042)		06.2012		GIRL-TRW	1	60	25/Ø288		X374749	X374750
		06.2012		GIRL-TRW	1	60	28	V. SPORT	X374753	X374754
		06.2012		GIRL-TRW	1	60	28/Ø295		X374751	X374752
A 180 CDI (176.000)		06.2012		GIRL-TRW	1	60	25/Ø288		X374749	X374750
		06.2012		GIRL-TRW	1	60	28	V. SPORT	X374753	X374754
A 180 CDI (176.012)		06.2012		GIRL-TRW	1	60	25/Ø288		X374749	X374750
		06.2012		GIRL-TRW	1	60	28	V. SPORT	X374753	X374754
A 200 (176.043)		06.2012		GIRL-TRW	1	60	28	V. SPORT	X374753	X374754
		06.2012		GIRL-TRW	1	60	28/Ø295		X374751	X374752
A 200 CDI (176.001)		06.2012		GIRL-TRW	1	60	28	V. SPORT	X374753	X374754
		06.2012		GIRL-TRW	1	60	28/Ø295		X374751	X374752
A 200 CDI (176.008)		02.2014		GIRL-TRW	1	60	28	V. SPORT	X374753	X374754
		02.2014		GIRL-TRW	1	60	28/Ø295		X374751	X374752
A 200 CDI 4-matic (176.002)		02.2014		GIRL-TRW	1	60	28	V. SPORT	X374753	X374754
A 220 CDI (176.003)		09.2012		GIRL-TRW	1	60	28/Ø295		X374751	X374752
Tout / All / Alle / Tutti / Todos		06.2012		GIRL-TRW	1	34	9/Ø276		X377059	X377060

CLASSE B (W245)

B 150 (245.231)		03.2005	11.2011	GIRL-TRW	1	57	22/Ø276		X374653	X374654
B 160 (245.231)		04.2009	11.2011	GIRL-TRW	1	57	22/Ø276		X374653	X374654
B 170 (245.232)		03.2005	11.2011	GIRL-TRW	1	57	22/Ø276		X374653	X374654
B 170 NGT (245.233)		04.2008	11.2011	GIRL-TRW	1	57	25/Ø288		X374657	X374658
B 180 (245.232)		04.2009	11.2011	GIRL-TRW	1	57	22/Ø276		X374653	X374654
B 180 CDI (245.207)		03.2005	11.2011	GIRL-TRW	1	57	25/Ø288		X374657	X374658
B 180 NGT (245.233)		04.2008	11.2011	GIRL-TRW	1	57	25/Ø288		X374657	X374658
B 200 (245.233)		03.2005	11.2011	GIRL-TRW	1	57	25/Ø288		X374657	X374658
B 200 CDI		03.2005	11.2011	GIRL-TRW	1	57	25/Ø288		X374657	X374658
B 200 CDI (245.208)		03.2005	11.2011	GIRL-TRW	1	57	25/Ø288		X374657	X374658
B 200 TURBO (245.234)		03.2005	11.2011	GIRL-TRW	1	57	25/Ø288		X374657	X374658
Tout / All / Alle / Tutti / Todos		03.2005	11.2011	GIRL-TRW	1	30	8		X375381	X375382

CLASSE B (W246)

B 160 CDI (246.211)		05.2013		GIRL-TRW	1	60	25/Ø288		X374749	X374750
		05.2013		GIRL-TRW	1	60	28	V. SPORT	X374753	X374754
		05.2013		GIRL-TRW	1	60	28/Ø295		X374751	X374752
B 180 (246.242)		11.2011		GIRL-TRW	1	60	25/Ø288		X374749	X374750
		11.2011		GIRL-TRW	1	60	28	V. SPORT	X374753	X374754
B 180 CDI (246.200)		11.2011		GIRL-TRW	1	60	25/Ø288		X374749	X374750
		11.2011		GIRL-TRW	1	60	28	V. SPORT	X374753	X374754
B 180 CDI (246.212)		02.2013		GIRL-TRW	1	60	25/Ø288		X374749	X374750
		02.2013		GIRL-TRW	1	60	28	V. SPORT	X374753	X374754
		02.2013		GIRL-TRW	1	60	28/Ø295		X374751	X374752

X=1 : SNRA - X=2 : EAI - X=3 : SERA - X=4 : SEEC - X=5 : NEOTO - X=6 : STARTCAR

Affectations par Marques

Vehicule application - Zuordnung nach Marke und Fahrzeuge - Applicazione per marca e veicolo - Aplicacion por marca y vehiculo



MERCEDES-BENZ

CLASSE B (W246)

B 200 (246.243)		11.2011		GIRL-TRW	1	60	28		V. SPORT	X374753	X374754
		11.2011		GIRL-TRW	1	60	28/Ø295			X374751	X374752
B 200 CDI (246.201)		11.2011		GIRL-TRW	1	60	28		V. SPORT	X374753	X374754
		11.2011		GIRL-TRW	1	60	28/Ø295			X374751	X374752
B 200 Natural Gas Drive (242.848)		11.2012		GIRL-TRW	1	60	28		V. SPORT	X374753	X374754
		11.2012		GIRL-TRW	1	60	28/Ø295			X374751	X374752
B 220 4-matic (246.247)		05.2013		GIRL-TRW	1	60	28/Ø295			X374751	X374752
B 220 CDI (246.203)		11.2011		GIRL-TRW	1	60	28/Ø295			X374751	X374752
Tout / All / Alle / Tutti / Todos		11.2011		GIRL-TRW	1	34	9/Ø276			X377059	X377060

CLASSE C (C204)

C 180 (204.331)		01.2013	01.2014	GIRL-TRW	1	60	25/Ø285			X374739	X374740
		01.2013	01.2014	GIRL-TRW	1	60	28/Ø295			X374771	X374772
		01.2013	01.2014	ATE	1	38	10			X225385	X225386
		01.2013	01.2014	ATE	1	38	9			X225383	X225384
C 180 (204.349)		06.2011	01.2014	GIRL-TRW	1	60	25/Ø285			X374739	X374740
		06.2011	01.2014	GIRL-TRW	1	60	28/Ø295			X374771	X374772
		06.2011	01.2014	GIRL-TRW	1	60	32/Ø344			X374773	X374774
		06.2011	01.2014	ATE	1	38	10			X225385	X225386
		06.2011	01.2014	ATE	1	40	22			X225389	X225390
C 200 CGI (204.348)		06.2011	01.2014	GIRL-TRW	1	60	28/Ø295			X374771	X374772
		06.2011	01.2014	GIRL-TRW	1	60	32/Ø344			X374773	X374774
		06.2011	01.2014	ATE	1	38	10			X225385	X225386
		06.2011	01.2014	ATE	1	40	22			X225389	X225390
C 220 CDI (204.302)		06.2011	01.2014	GIRL-TRW	1	60	28/Ø295			X374771	X374772
		06.2011	01.2014	ATE	1	38	10			X225385	X225386
C 250 (204.347)		06.2011	01.2014	GIRL-TRW	1	60	28/Ø295			X374771	X374772
		06.2011	01.2014	GIRL-TRW	1	60	32/Ø344			X374773	X374774
		06.2011	01.2014	ATE	1	38	10			X225385	X225386
		06.2011	01.2014	ATE	1	40	22			X225389	X225390
C 250 CDI (204.303)		06.2011	01.2014	GIRL-TRW	1	60	28/Ø295			X374771	X374772
		06.2011	01.2014	GIRL-TRW	1	60	32/Ø344			X374773	X374774
		06.2011	01.2014	ATE	1	40	22			X225389	X225390
C 350 (204.357)		06.2011	01.2014	GIRL-TRW	1	60	32/Ø322			X374769	X374770
		06.2011	01.2014	ATE	1	40	22			X225389	X225390

CLASSE C (CL203)

C 160 Kompressor (203.730)		05.2002	05.2008	GIRL-TRW	1	57	25/Ø288			X374607	X374608
		05.2002	05.2008	ATE	2	36	9/Ø278			X225249	X225250
C 180 (203.735)		03.2001	05.2002	GIRL-TRW	1	57	25/Ø288			X374607	X374608
		03.2001	05.2002	ATE	2	36	9/Ø278			X225249	X225250
C 180 Kompressor (203.746)		05.2002	05.2008	GIRL-TRW	1	57	25/Ø288			X374607	X374608
		05.2002	05.2008	ATE	2	36	9/Ø278			X225249	X225250
C 200 CDI (203.707)		03.2003	05.2008	GIRL-TRW	1	57	25/Ø288			X374607	X374608
		03.2003	05.2008	ATE	2	36	9/Ø278			X225249	X225250

X=1 : SNRA - X=2 : EAI - X=3 : SERA - X=4 : SEEC - X=5 : NEOTO - X=6 : STARTCAR

Affectations par Marques

Vehicule application - Zuordnung nach Marke und Fahrzeuge - Applicazione per marca e veicolo - Aplicacion por marca y vehiculo



MERCEDES-BENZ

CLASSE C (CL203)

C 200 CGI Kompressor (203.743)		03.2003	09.2005	GIRL-TRW	1	57	28/Ø300		X374605	X374606
		03.2003	09.2005	ATE	2	36	10/Ø290		X225313	X225314
C 200 Kompressor (203.742)		05.2002	05.2008	GIRL-TRW	1	57	28/Ø300		X374605	X374606
		05.2002	05.2008	ATE	2	36	10/Ø290		X225313	X225314
C 200 Kompressor (203.745)		03.2001	05.2002	GIRL-TRW	1	57	25/Ø288		X374607	X374608
		03.2001	05.2002	ATE	2	36	9/Ø278		X225249	X225250
C 220		05.2002	04.2005	GIRL-TRW	1	57	28/Ø300		X374605	X374606
		05.2002	04.2005	ATE	2	36	10/Ø290		X225313	X225314
C 220 CDI		03.2001	05.2008	GIRL-TRW	1	57	25/Ø288		X374607	X374608
		03.2001	05.2008	ATE	2	36	9/Ø278		X225249	X225250
C 220 CDI (203.706)		03.2001	05.2008	GIRL-TRW	1	57	25/Ø288		X374607	X374608
		03.2001	05.2008	ATE	2	36	9/Ø278		X225249	X225250
C 220 CDI (203.708)		02.2004	05.2008	GIRL-TRW	1	57	25/Ø288		X374607	X374608
		02.2004	05.2008	ATE	2	36	9/Ø278		X225249	X225250
C 230 (203.752)		01.2005	05.2008	GIRL-TRW	1	57	28/Ø300		X374605	X374606
		01.2005	05.2008	ATE	2	36	10/Ø290		X225313	X225314
C 230 Kompressor (203.740)		05.2002	05.2008	GIRL-TRW	1	57	28/Ø300		X374605	X374606
		05.2002	05.2008	ATE	2	36	10/Ø290		X225313	X225314
C 230 Kompressor (203.747)		03.2001	05.2002	GIRL-TRW	1	57	28/Ø300		X374605	X374606
		03.2001	05.2002	ATE	2	36	10/Ø290		X225313	X225314
C 30 CDI AMG (203.718)		09.2002	05.2008	BREMBO	4	40/44	30/Ø345		X284221	X284222
C 320 (203.764, 203.264, 203.064)		09.2002	12.2005	GIRL-TRW	1	57	28/Ø300		X374605	X374606
		09.2002	12.2005	ATE	2	36	10/Ø290		X225313	X225314
C 350 (203.756)		01.2005	05.2008	BREMBO	2	57	28/Ø330		X284121	X284122
		01.2005	05.2008	ATE	2	36	10/Ø290		X225313	X225314

CLASSE C (S202)

C 180 T (202.078)		06.1996	09.2000	GIRL-TRW	1	54	22		X374527	X374528
		06.1996	09.2000	ATE	2	35	9/Ø258	2 axe pour plaquettes	X225125	X225126
		06.1996	09.2000	ATE	2	36	9	1 axe pour plaquettes	X225223	X225224
		06.1996	09.2000	BENDIX	2	35	9		X255017	X255018
C 180 T (202.081)		09.2000	03.2001	GIRL-TRW	1	54	22		X374527	X374528
		09.2000	03.2001	ATE	2	36	9	1 axe pour plaquettes	X225223	X225224
C 200 T (202.080)		06.1996	10.2000	GIRL-TRW	1	54	22		X374527	X374528
		06.1996	10.2000	ATE	2	35	9/Ø258	2 axe pour plaquettes	X225125	X225126
		06.1996	10.2000	ATE	2	36	9	1 axe pour plaquettes	X225223	X225224
		06.1996	03.2001	BENDIX	2	35	9		X255017	X255018
C 200 T CDI (202.194)		03.1998	10.2000	GIRL-TRW	1	54	22		X374527	X374528
		03.1998	10.2000	ATE	2	36	9	1 axe pour plaquettes	X225223	X225224
C 200 T D (202.180)		10.1996	05.2000	GIRL-TRW	1	54	22		X374527	X374528
		10.1996	05.2000	ATE	2	35	9/Ø258	2 axe pour plaquettes	X225125	X225126
		10.1996	05.2000	ATE	2	36	9	1 axe pour plaquettes	X225223	X225224
		10.1996	03.2001	BENDIX	2	35	9		X255017	X255018

X=1 : SNRA - X=2 : EAI - X=3 : SERA - X=4 : SEEAC - X=5 : NEOTO - X=6 : STARTCAR

Affectations par Marques

Vehicule application - Zuordnung nach Marke und Fahrzeuge - Applicazione per marca e veicolo - Aplicacion por marca y vehiculo



MERCEDES-BENZ

CLASSE C (S202)

C 200 T Kompressor (202.087)		09.2000	03.2001	ATE	1	57	25			X224437	X224438
		09.2000	03.2001	ATE	2	36	9		1 axe pour plaquettes	X225223	X225224
C 200 T Kompressor (202.082)		11.1996	10.2000	ATE	1	57	25			X224437	X224438
		11.1996	10.2000	ATE	2	36	9		1 axe pour plaquettes	X225223	X225224
		11.1996	10.2000	ATE	2	38	9		2 axe pour plaquettes	X225191	X225192
C 220 T CDI (202.193)		09.1997	10.2000	GIRL-TRW	1	54	22			X374527	X374528
		09.1997	10.2000	ATE	2	35	9/Ø258		2 axe pour plaquettes	X225125	X225126
		09.1997	10.2000	ATE	2	36	9		1 axe pour plaquettes	X225223	X225224
		09.1997	03.2001	BENDIX	2	35	9			X255017	X255018
C 220 T D		06.1996	07.1999	GIRL-TRW	1	54	22			X374527	X374528
		06.1996	07.1999	ATE	2	35	9/Ø258		2 axe pour plaquettes	X225125	X225126
		06.1996	07.1999	ATE	2	36	9		1 axe pour plaquettes	X225223	X225224
		06.1996	03.2001	BENDIX	2	35	9			X255017	X255018
C 220 T D (202.182)		06.1996	09.1998	GIRL-TRW	1	54	22			X374527	X374528
		06.1996	09.1998	ATE	2	35	9/Ø258		2 axe pour plaquettes	X225125	X225126
		06.1996	09.1998	ATE	2	36	9		1 axe pour plaquettes	X225223	X225224
		06.1996	09.1998	BENDIX	2	35	9			X255017	X255018
C 230 T (202.083)		06.1996	06.1998	GIRL-TRW	1	54	22			X374527	X374528
		06.1996	06.1998	ATE	2	36	9		1 axe pour plaquettes	X225223	X225224
		06.1996	06.1998	ATE	2	38	9/Ø278		2 axe pour plaquettes	X225191	X225192
C 230 T Kompressor (202.085)		06.1997	10.1999	ATE	1	57	25			X224437	X224438
		06.1997	10.1999	ATE	2	36	9		1 axe pour plaquettes	X225223	X225224
C 240 T (202.086)		06.1997	09.2000	ATE	1	57	25			X224437	X224438
		06.1997	09.2000	ATE	2	36	9		1 axe pour plaquettes	X225223	X225224
C 240 T (202.088)		09.2000	03.2001	ATE	1	57	25			X224437	X224438
		09.2000	03.2001	ATE	2	36	9		1 axe pour plaquettes	X225223	X225224
C 250 T Turbo-D (202.188)		06.1996	10.2000	ATE	1	57	25			X224437	X224438
		06.1996	10.2000	ATE	2	36	9		1 axe pour plaquettes	X225223	X225224
		06.1996	10.2000	ATE	2	38	9/Ø278		2 axe pour plaquettes	X225191	X225192
C 280 T (202.089)		06.1997	10.2000	ATE	1	57	25			X224437	X224438
		06.1997	10.2000	ATE	2	36	9		1 axe pour plaquettes	X225223	X225224
C 43 AMG (202.093)		08.1997	05.2000	ATE	2	42	20			X225165	X225166

CLASSE C (W202)

C 180 (202.018)		03.1993	05.2000	GIRL-TRW	1	54	12		#ID: 4386 4387	X374207	X374208
		03.1993	05.2000	GIRL-TRW	1	54	12		#ID: 5383 5384	X374491	X374492
		03.1993	05.2000	ATE	2	35	9		1 axe pour plaquettes	X225275	X225276
		03.1993	05.2000	ATE	2	35	9		2 axe pour plaquettes	X225125	X225126
		03.1993	05.2000	BENDIX	2	35	9			X255017	X255018
C 200 (202.020)		01.1994	07.1997	GIRL-TRW	1	54	22		#ID: 4933 4934	X374209	X374210
		01.1994	05.2000	GIRL-TRW	1	54	22		#ID: 5395 5396	X374527	X374528
		01.1994	05.2000	ATE	2	35	9		1 axe pour plaquettes	X225275	X225276
		01.1994	05.2000	ATE	2	35	9/Ø258		2 axe pour plaquettes	X225125	X225126
		01.1994	05.2000	BENDIX	2	35	9			X255017	X255018

X=1 : SNRA - X=2 : EAI - X=3 : SERA - X=4 : SEEC - X=5 : NEOTO - X=6 : STARTCAR

Affectations par Marques

Vehicule application - Zuordnung nach Marke und Fahrzeuge - Applicazione per marca e veicolo - Aplicacion por marca y vehiculo



MERCEDES-BENZ

CLASSE C (W202)

C 200 CDI (202.134)		03.1998	05.2000	GIRL-TRW	1	54	22	#ID: 5395 5396	X374527	X374528
		03.1998	05.2000	ATE	2	35	9	1 axe pour plaquettes	X225275	X225276
C 200 D (202.120)		03.1993	05.2000	GIRL-TRW	1	54	12	#ID: 4386 4387	X374207	X374208
		03.1993	05.2000	ATE	2	35	9	1 axe pour plaquettes	X225275	X225276
		03.1993	05.2000	ATE	2	35	9/Ø258	2 axe pour plaquettes	X225125	X225126
		03.1993	05.2000	BENDIX	2	35	9		X255017	X255018
C 200 D (202.122)		10.1996	05.2000	GIRL-TRW	1	54	12	#ID: 5383 5384	X374491	X374492
		10.1996	05.2000	ATE	2	35	9	1 axe pour plaquettes	X225275	X225276
		10.1996	05.2000	ATE	2	35	9/Ø258	2 axe pour plaquettes	X225125	X225126
		10.1996	05.2000	BENDIX	2	35	9		X255017	X255018
C 200 Kompressor (202.025)		10.1995	05.2000	ATE	1	57	25		X224437	X224438
		10.1995	05.2000	ATE	2	36	9	1 axe pour plaquettes	X225223	X225224
		10.1995	05.2000	ATE	2	38	9/Ø278	2 axe pour plaquettes	X225191	X225192
C 220 (202.022)		03.1993	05.2000	GIRL-TRW	1	54	22	#ID: 4933 4934	X374209	X374210
		03.1993	05.2000	ATE	2	35	9	1 axe pour plaquettes	X225275	X225276
		03.1993	05.2000	ATE	2	35	9/Ø258	2 axe pour plaquettes	X225125	X225126
		03.1993	05.2000	BENDIX	2	35	9		X255017	X255018
C 220 CDI (202.133)		09.1997	05.2000	GIRL-TRW	1	54	22	#ID: 5395 5396	X374527	X374528
		09.1997	05.2000	ATE	2	35	9	1 axe pour plaquettes	X225275	X225276
C 220 D		07.1996	05.1997	GIRL-TRW	1	54	12	#ID: 4386 4387	X374207	X374208
		07.1996	05.2000	GIRL-TRW	1	54	12	#ID: 5383 5384	X374491	X374492
		07.1996	05.2000	ATE	2	35	9	1 axe pour plaquettes	X225275	X225276
		07.1996	05.2000	ATE	2	35	9/Ø258	2 axe pour plaquettes	X225125	X225126
		07.1996	05.2000	BENDIX	2	35	9		X255017	X255018
C 220 D (202.121)		08.1993	05.1997	GIRL-TRW	1	54	12	#ID: 4386 4387	X374207	X374208
		08.1993	05.2000	GIRL-TRW	1	54	12	#ID: 5383 5384	X374491	X374492
		08.1993	06.1998	ATE	2	35	9	1 axe pour plaquettes	X225275	X225276
		08.1993	06.1998	ATE	2	35	9/Ø258	2 axe pour plaquettes	X225125	X225126
		08.1993	05.2000	BENDIX	2	35	9		X255017	X255018
C 230 (202.023)		06.1996	06.1997	GIRL-TRW	1	54	22	#ID: 5395 5396	X374527	X374528
		06.1996	06.1997	ATE	2	35	9	1 axe pour plaquettes	X225275	X225276
C 230 Kompressor (202.024)		10.1995	05.2000	ATE	1	57	25		X224437	X224438
		10.1995	05.2000	ATE	2	36	9	1 axe pour plaquettes	X225223	X225224
		10.1995	05.2000	ATE	2	38	9/Ø278	2 axe pour plaquettes	X225191	X225192
C 240 (202.026)		06.1997	05.2000	ATE	1	57	25		X224437	X224438
		06.1997	05.2000	ATE	2	36	9	1 axe pour plaquettes	X225223	X225224
		06.1997	05.2000	ATE	2	38	9/Ø278	2 axe pour plaquettes	X225191	X225192
C 250 D (202.125)		05.1993	12.1994	GIRL-TRW	1	54	12	#ID: 4386 4387	X374207	X374208
		05.1993	05.2000	GIRL-TRW	1	54	12	#ID: 5383 5384	X374491	X374492
		05.1993	05.2000	ATE	2	35	9	1 axe pour plaquettes	X225275	X225276
		05.1993	05.2000	ATE	2	35	9/Ø258	2 axe pour plaquettes	X225125	X225126
		05.1993	05.2000	BENDIX	2	35	9		X255017	X255018

Affectations par Marques

Vehicule application - Zuordnung nach Marke und Fahrzeuge - Applicazione per marca e veicolo - Aplicacion por marca y vehiculo



MERCEDES-BENZ

CLASSE C (W202)

C 250 Turbo-D (202.128)		10.1995	05.2000	ATE	1	57	25			X224437	X224438
		10.1995	05.2000	ATE	2	36	9		1 axe pour plaquettes	X225223	X225224
		10.1995	05.2000	ATE	2	38	9/Ø278		2 axe pour plaquettes	X225191	X225192
C 280 (202.028)		05.1993	05.2000	GIRL-TRW	1	54	22			X374209	X374210
		05.1993	05.2000	ATE	2	35	9		1 axe pour plaquettes	X225275	X225276
		05.1993	05.2000	ATE	2	35	9/Ø258		2 axe pour plaquettes	X225125	X225126
		05.1993	05.2000	ATE	2	36	9		1 axe pour plaquettes	X225223	X225224
		05.1993	05.2000	ATE	2	38	9/Ø278		2 axe pour plaquettes	X225191	X225192
		05.1993	05.2000	BENDIX	2	35	9			X255017	X255018
C 280 (202.029)		06.1997	05.2000	ATE	1	57	25			X224437	X224438
		06.1997	05.2000	ATE	2	36	9		1 axe pour plaquettes	X225223	X225224
C 36 AMG (202.028)		05.1994	05.2000	ATE	4	38/42	28			X224667	X224668
		05.1994	05.2000	ATE	2	36	10			X225221	X225222
C 43 AMG (202.033)		08.1997	05.2000	ATE	2	42	20/Ø300			X225165	X225166

CLASSE C (W203)

C 180 (203.035)		10.2000	05.2002	GIRL-TRW	1	57	25/Ø288			X374607	X374608
		10.2000	05.2002	ATE	2	36	9/Ø278			X225249	X225250
C 180 Kompressor (203.046)		05.2002	02.2007	BREMBO	2	57	28/Ø330			X284121	X284122
		05.2002	04.2004	BREMBO	4	40/44	28/Ø330			X284245	X284246
		05.2002	02.2007	GIRL-TRW	1	57	25/Ø288			X374607	X374608
		05.2002	02.2007	ATE	2	36	10/Ø290			X225313	X225314
		05.2002	02.2007	ATE	2	36	9/Ø278			X225249	X225250
C 200 CDI		02.2001	03.2004	BREMBO	4	40/44	28/Ø330			X284245	X284246
		02.2001	03.2004	GIRL-TRW	1	57	25/Ø288			X374607	X374608
		02.2001	03.2004	ATE	2	36	10/Ø290			X225313	X225314
		02.2001	03.2004	ATE	2	36	9/Ø278			X225249	X225250
C 200 CDI (203.004)		09.2000	03.2004	BREMBO	4	40/44	28/Ø330			X284245	X284246
		09.2000	03.2004	GIRL-TRW	1	57	25/Ø288			X374607	X374608
		09.2000	03.2004	ATE	2	36	10/Ø290			X225313	X225314
		09.2000	03.2004	ATE	2	36	9/Ø278			X225249	X225250
C 200 CDI (203.007)		04.2003	02.2007	BREMBO	2	57	28/Ø330			X284121	X284122
		04.2003	04.2004	BREMBO	4	40/44	28/Ø330			X284245	X284246
		04.2003	02.2007	GIRL-TRW	1	57	25/Ø288			X374607	X374608
		04.2003	02.2007	ATE	2	36	10/Ø290			X225313	X225314
		04.2003	02.2007	ATE	2	36	9/Ø278			X225249	X225250
C 200 CGI Kompressor (203.043)		07.2003	02.2007	BREMBO	2	57	28/Ø330			X284121	X284122
		07.2003	07.2004	BREMBO	4	40/44	28/Ø330			X284245	X284246
		07.2003	07.2004	GIRL-TRW	1	57	25/Ø288			X374607	X374608
		07.2003	07.2004	ATE	2	36	10/Ø290			X225313	X225314
		07.2003	07.2004	ATE	2	36	9/Ø278			X225249	X225250

Affectations par Marques

Vehicule application - Zuordnung nach Marke und Fahrzeuge - Applicazione per marca e veicolo - Aplicacion por marca y vehiculo



MERCEDES-BENZ

CLASSE C (W203)

C 200 Kompressor (203.042)		05.2002	02.2007	BREMBO	2	57	28/Ø330		X284121	X284122
		05.2002	04.2004	BREMBO	4	40/44	28/Ø330		X284245	X284246
		05.2002	02.2007	GIRL-TRW	1	57	25/Ø288		X374607	X374608
		05.2002	02.2007	ATE	2	36	10/Ø290		X225313	X225314
		05.2002	02.2007	ATE	2	36	9/Ø278		X225249	X225250
C 200 Kompressor (203.045)		05.2000	06.2002	GIRL-TRW	1	57	25/Ø288		X374607	X374608
		05.2000	06.2002	ATE	2	36	9/Ø278		X225249	X225250
C 220 CDI (203.006)		05.2000	12.2004	BREMBO	4	40/44	28/Ø330		X284245	X284246
		05.2000	12.2004	GIRL-TRW	1	57	25/Ø288		X374607	X374608
		05.2000	12.2004	ATE	2	36	10/Ø290		X225313	X225314
		05.2000	12.2004	ATE	2	36	9/Ø278		X225249	X225250
C 220 CDI (203.008)		02.2003	02.2007	BREMBO	2	57	28/Ø330		X284121	X284122
		02.2003	04.2004	BREMBO	4	40/44	28/Ø330		X284245	X284246
		02.2003	02.2007	GIRL-TRW	1	57	25/Ø288		X374607	X374608
		02.2003	02.2007	ATE	2	36	10/Ø290		X225313	X225314
		02.2003	02.2007	ATE	2	36	9/Ø278		X225249	X225250
C 230 (203.052)		01.2005	02.2007	BREMBO	2	57	28/Ø330		X284121	X284122
		01.2005	02.2007	GIRL-TRW	1	57	28/Ø300		X374605	X374606
		01.2005	02.2007	ATE	2	36	10/Ø290		X225313	X225314
C 230 Kompressor (203.040)		02.2004	02.2007	BREMBO	2	57	28/Ø330		X284121	X284122
		02.2004	02.2007	BREMBO	4	40/44	28/Ø330		X284245	X284246
		02.2004	02.2007	GIRL-TRW	1	57	28/Ø300		X374605	X374606
		02.2004	02.2007	ATE	2	36	10/Ø290		X225313	X225314
C 240 (203.061)		05.2000	12.2005	BREMBO	2	57	28/Ø330		X284121	X284122
		05.2000	04.2004	BREMBO	4	40/44	28/Ø330		X284245	X284246
		05.2000	12.2005	GIRL-TRW	1	57	28/Ø300		X374605	X374606
		05.2000	12.2005	ATE	2	36	10/Ø290		X225313	X225314
C 240 4-matic (203.081, 203.281)		07.2002	12.2005	GIRL-TRW	1	57	28/Ø300		X374719	X374720
		07.2002	12.2005	ATE	2	36	10/Ø290		X225313	X225314
C 270 CDI (203.016)		12.2000	12.2004	BREMBO	2	57	28/Ø330		X284121	X284122
		12.2000	04.2004	BREMBO	4	40/44	28/Ø330		X284245	X284246
		12.2000	12.2004	GIRL-TRW	1	57	28/Ø300		X374605	X374606
		12.2000	12.2004	ATE	2	36	10/Ø290		X225313	X225314
C 280 (203.054)		01.2005	02.2007	BREMBO	2	57	28/Ø330		X284121	X284122
		01.2005	02.2007	GIRL-TRW	1	57	28/Ø300		X374605	X374606
		01.2005	02.2007	ATE	2	36	10/Ø290		X225313	X225314
C 280 4-matic (203.092)		01.2005	02.2007	BREMBO	2	57	28/Ø330		X284121	X284122
		01.2005	02.2007	GIRL-TRW	1	57	28/Ø300		X374719	X374720
		01.2005	02.2007	ATE	2	36	10/Ø290		X225313	X225314
C 30 CDI AMG (203.018)		01.2003	12.2004	BREMBO	4	40/44	30/Ø345		X284221	X284222
C 32 AMG Kompressor (203.065)		02.2001	12.2004	BREMBO	4	40/44	30/Ø345		X284221	X284222

Affectations par Marques

Vehicule application - Zuordnung nach Marke und Fahrzeuge - Applicazione per marca e veicolo - Aplicacion por marca y vehiculo



MERCEDES-BENZ

CLASSE C (W203)

C 320 (203.064, 203.264, 203.764)		05.2000	07.2005	BREMBO	2	57	28/Ø330		X284121	X284122
		05.2000	04.2004	BREMBO	4	40/44	28/Ø330		X284245	X284246
		05.2000	07.2005	GIRL-TRW	1	57	28/Ø300		X374605	X374606
		05.2000	07.2005	ATE	2	36	10/Ø290		X225313	X225314
C 320 4-matic (203.084, 203.284)		07.2002	07.2005	GIRL-TRW	1	57	28/Ø300		X374719	X374720
		07.2002	07.2005	ATE	2	36	10/Ø290		X225313	X225314
C 320 CDI (203.020)		01.2005	02.2007	BREMBO	2	57	28/Ø330		X284121	X284122
		01.2005	02.2007	BREMBO	4	40/44	30/Ø345		X284221	X284222
		01.2005	02.2007	ATE	2	36	10/Ø290		X225313	X225314
C 350 (203.056)		01.2005	02.2007	BREMBO	2	57	28/Ø330		X284121	X284122
		01.2005	02.2007	BREMBO	4	40/44	30/Ø345		X284221	X284222
		01.2005	02.2007	ATE	2	36	10/Ø290		X225313	X225314
C 350 4-matic (203.087)		01.2005	02.2007	BREMBO	4	40/44	30/Ø345		X284221	X284222
		01.2005	02.2007	ATE	2	36	10/Ø290		X225313	X225314
C 55 AMG (203.076)		02.2004	02.2007	BREMBO	4	40/44	30/Ø345		X284221	X284222

CLASSE C (W204)

C 180 CDI (204.000)		01.2011		GIRL-TRW	1	60	25/Ø285		X374739	X374740
		01.2011		GIRL-TRW	1	60	28/Ø295		X374771	X374772
		01.2011		ATE	1	38	10		X225385	X225386
		01.2011		ATE	1	38	9		X225383	X225384
C 180 CGI (204.031)		01.2008		GIRL-TRW	1	60	25/Ø285		X374739	X374740
		01.2008		GIRL-TRW	1	60	28/Ø295		X374771	X374772
		01.2008		ATE	1	38	10		X225385	X225386
C 180 CGI (204.049)		01.2007		GIRL-TRW	1	60	25/Ø285		X374739	X374740
		01.2007		GIRL-TRW	1	60	28/Ø295		X374771	X374772
		01.2007		ATE	1	38	10		X225385	X225386
		01.2007		ATE	1	38	9		X225383	X225384
C 180 Kompressor (204.044, 204.045)		01.2008		GIRL-TRW	1	60	25/Ø285		X374739	X374740
		01.2008		GIRL-TRW	1	60	28/Ø295		X374771	X374772
		01.2008		ATE	1	38	10		X225385	X225386
		01.2008		ATE	1	38	9		X225383	X225384
C 180 Kompressor (204.046)		01.2007		GIRL-TRW	1	60	25/Ø285		X374739	X374740
		01.2007		GIRL-TRW	1	60	28/Ø295		X374771	X374772
		01.2007		ATE	1	38	10		X225385	X225386
		01.2007		ATE	1	38	9		X225383	X225384
C 200 CDI (204.001)		01.2011		GIRL-TRW	1	60	25/Ø285		X374739	X374740
		01.2011		GIRL-TRW	1	60	28/Ø295		X374771	X374772
		01.2011		ATE	1	38	10		X225385	X225386
		01.2011		ATE	1	38	9		X225383	X225384
C 200 CDI (204.007)		01.2007		GIRL-TRW	1	60	25/Ø285		X374739	X374740
		01.2007		GIRL-TRW	1	60	28/Ø295		X374771	X374772
		01.2007		ATE	1	38	10		X225385	X225386
		01.2007		ATE	1	38	9		X225383	X225384

X=1 : SNRA - X=2 : EAI - X=3 : SERA - X=4 : SEEC - X=5 : NEOTO - X=6 : STARTCAR

Affectations par Marques

Vehicule application - Zuordnung nach Marke und Fahrzeuge - Applicazione per marca e veicolo - Aplicacion por marca y vehiculo



MERCEDES-BENZ

CLASSE C (W204)

C 200 CGI (204.048)		01.2007		GIRL-TRW	1	60	28/Ø295		X374771	X374772
		01.2007		ATE	1	38	10		X225385	X225386
		01.2007		ATE	1	38	9		X225383	X225384
C 200 Kompressor (204.041)		01.2007		GIRL-TRW	1	60	28/Ø295		X374771	X374772
		01.2007		ATE	1	38	10		X225385	X225386
		01.2007		ATE	1	38	9		X225383	X225384
C 220 BlueTEC		04.2010		ATE	1	38	10		X225385	X225386
		04.2010		ATE	1	38	9		X225383	X225384
C 220 CDI		01.2007		GIRL-TRW	1	60	28/Ø295		X374771	X374772
		01.2007		ATE	1	38	10		X225385	X225386
		01.2007		ATE	1	38	9		X225383	X225384
C 220 CDI (204.002)		12.2008		GIRL-TRW	1	60	28/Ø295		X374771	X374772
		12.2008		ATE	1	38	10		X225385	X225386
		12.2008		ATE	1	38	9		X225383	X225384
C 220 CDI (204.008)		01.2007		GIRL-TRW	1	60	28/Ø295		X374771	X374772
		01.2007		ATE	1	38	10		X225385	X225386
		01.2007		ATE	1	38	9		X225383	X225384
C 220 CDI 4-matic (204.084)		02.2013		ATE	1	38	10		X225385	X225386
		02.2013		ATE	1	38	9		X225383	X225384
C 230 (204.052)		01.2007		GIRL-TRW	1	60	28/Ø295		X374771	X374772
		01.2007		ATE	1	38	10		X225385	X225386
		01.2007		ATE	1	38	9		X225383	X225384
C 230 4-matic (204.085)		07.2007	12.2010	ATE	1	38	10		X225385	X225386
		07.2007	12.2010	ATE	1	38	9		X225383	X225384
C 250 CDI (204.003)		08.2008		GIRL-TRW	1	60	28/Ø295		X374771	X374772
		08.2008		ATE	1	40	22		X225387	X225388
		08.2008		ATE	1	40	22		X225389	X225390
C 250 CDI 4-matic (204.082)		01.2011		ATE	1	38	10		X225385	X225386
		01.2011		ATE	1	38	9		X225383	X225384
		01.2011		ATE	1	40	22		X225387	X225388
		01.2011		ATE	1	40	22		X225389	X225390
C 250 CGI (204.047)		07.2009		GIRL-TRW	1	60	28/Ø295		X374771	X374772
		07.2009		ATE	1	38	10		X225385	X225386
		07.2009		ATE	1	38	9		X225383	X225384
C 280 (204.054)		01.2007		GIRL-TRW	1	60	28/Ø295		X374771	X374772
		01.2007		ATE	1	38	10		X225385	X225386
		01.2007		ATE	1	38	9		X225383	X225384
C 280 4-matic (204.081)		07.2007		ATE	1	38	10		X225385	X225386
		07.2007		ATE	1	38	9		X225383	X225384
C 300 (204.054)		07.2009		GIRL-TRW	1	60	28/Ø295		X374771	X374772
		07.2009		ATE	1	38	10		X225385	X225386
		07.2009		ATE	1	38	9		X225383	X225384

Affectations par Marques

Vehicule application - Zuordnung nach Marke und Fahrzeuge - Applicazione per marca e veicolo - Aplicacion por marca y vehiculo



MERCEDES-BENZ

CLASSE C (W204)

C 300 (204.055)		02.2011		GIRL-TRW	1	60	32/Ø322		X374769	X374770
		02.2011		ATE	1	40	22		X225389	X225390
C 300 4-matic (204.080)		02.2011		ATE	1	40	22		X225389	X225390
C 300 4-matic (204.081)		07.2007		ATE	1	38	10		X225385	X225386
		07.2007		ATE	1	38	9		X225383	X225384
C 300 CDI 4-matic (204.092)		01.2011		ATE	1	40	22		X225387	X225388
		01.2011		ATE	1	40	22		X225389	X225390
C 320 CDI (204.022)		01.2007		GIRL-TRW	1	60	32/Ø322		X374769	X374770
		01.2007		ATE	1	40	22		X225387	X225388
		01.2007		ATE	1	40	22		X225389	X225390
C 320 CDI 4-matic (204.089)		07.2007		ATE	1	40	22		X225387	X225388
		07.2007		ATE	1	40	22		X225389	X225390
C 350 (204.056)		01.2007		GIRL-TRW	1	60	32/Ø322		X374769	X374770
		01.2007		ATE	1	40	22		X225387	X225388
		01.2007		ATE	1	40	22		X225389	X225390
C 350 (204.057)		01.2011		GIRL-TRW	1	60	32/Ø322		X374769	X374770
		01.2011		ATE	1	40	22		X225389	X225390
C 350 4-matic (204.087)		07.2007	12.2011	ATE	1	40	22		X225387	X225388
		07.2007	12.2011	ATE	1	40	22		X225389	X225390
C 350 4-matic (204.088)		01.2011		ATE	1	40	22		X225389	X225390
C 350 CDI (204.022)		07.2009		GIRL-TRW	1	60	32/Ø322		X374769	X374770
		07.2009		ATE	1	40	22		X225387	X225388
		07.2009		ATE	1	40	22		X225389	X225390
C 350 CDI (204.023)		06.2011		GIRL-TRW	1	60	32/Ø322		X374769	X374770
		06.2011		ATE	1	40	22		X225387	X225388
		06.2011		ATE	1	40	22		X225389	X225390
C 350 CDI (204.025)		10.2009		GIRL-TRW	1	60	32/Ø322		X374769	X374770
		10.2009		ATE	1	40	22		X225387	X225388
		10.2009		ATE	1	40	22		X225389	X225390
C 350 CDI 4-matic (204.089)		07.2009	12.2011	ATE	1	40	22		X225387	X225388
		07.2009	12.2011	ATE	1	40	22		X225389	X225390
C 350 CDI 4-matic (204.092)		10.2009		ATE	1	40	22		X225387	X225388
		10.2009		ATE	1	40	22		X225389	X225390
C 350 CGI (204.065)		09.2008		GIRL-TRW	1	60	32/Ø322		X374769	X374770
		09.2008		ATE	1	40	22		X225387	X225388
		09.2008		ATE	1	40	22		X225389	X225390

CLASSE C T-Model (S203)

C 180 (203.235)		03.2001	05.2002	GIRL-TRW	1	57	25/Ø288		X374607	X374608
		03.2001	05.2002	ATE	2	36	10/Ø290		X225313	X225314
C 180 Kompressor (203.246)		05.2002	08.2007	BREMBO	2	57	28/Ø330		X284121	X284122
		05.2002	04.2004	BREMBO	4	^{40/44}	28/Ø330		X284245	X284246
		05.2002	08.2007	GIRL-TRW	1	57	25/Ø288		X374607	X374608
		05.2002	08.2007	ATE	2	36	10/Ø290		X225313	X225314

X=1 : SNRA - X=2 : EAI - X=3 : SERA - X=4 : SEEAC - X=5 : NEOTO - X=6 : STARTCAR

Affectations par Marques

Vehicule application - Zuordnung nach Marke und Fahrzeuge - Applicazione per marca e veicolo - Aplicacion por marca y vehiculo



MERCEDES-BENZ

CLASSE C T-Model (S203)

C 200 CDI (203.204)		03.2001	07.2003	BREMBO	4	40/44	28/Ø330		X284245	X284246
		03.2001	07.2003	GIRL-TRW	1	57	25/Ø288		X374607	X374608
		03.2001	07.2003	ATE	2	36	10/Ø290		X225313	X225314
C 200 CDI (203.204, 203.207)		03.2001	08.2007	BREMBO	4	40/44	28/Ø330		X284245	X284246
		03.2001	08.2007	GIRL-TRW	1	57	25/Ø288		X374607	X374608
		03.2001	08.2007	ATE	2	36	10/Ø290		X225313	X225314
C 200 CDI (203.207)		04.2003	08.2007	BREMBO	2	57	28/Ø330		X284121	X284122
		04.2003	04.2004	BREMBO	4	40/44	28/Ø330		X284245	X284246
		04.2003	08.2007	GIRL-TRW	1	57	25/Ø288		X374607	X374608
		04.2003	08.2007	ATE	2	36	10/Ø290		X225313	X225314
C 200 CGI Kompressor (203.243)		07.2003	07.2004	BREMBO	4	40/44	28/Ø330		X284245	X284246
		07.2003	07.2004	GIRL-TRW	1	57	25/Ø288		X374607	X374608
		07.2003	07.2004	ATE	2	36	10/Ø290		X225313	X225314
C 200 Kompressor (203.242)		05.2002	08.2007	BREMBO	2	57	28/Ø330		X284121	X284122
		05.2002	04.2004	BREMBO	4	40/44	28/Ø330		X284245	X284246
		05.2002	08.2007	GIRL-TRW	1	57	25/Ø288		X374607	X374608
		05.2002	08.2007	ATE	2	36	10/Ø290		X225313	X225314
C 200 Kompressor (203.245)		03.2001	05.2002	GIRL-TRW	1	57	25/Ø288		X374607	X374608
		03.2001	05.2002	ATE	2	36	10/Ø290		X225313	X225314
C 220 CDI (203.206)		03.2001	08.2007	BREMBO	4	40/44	28/Ø330		X284245	X284246
		03.2001	08.2007	GIRL-TRW	1	57	25/Ø288		X374607	X374608
		03.2001	08.2007	ATE	2	36	10/Ø290		X225313	X225314
C 220 CDI (203.208)		02.2004	08.2007	BREMBO	2	57	28/Ø330		X284121	X284122
		02.2004		BREMBO	4	40/44	28/Ø330		X284245	X284246
		02.2004	08.2007	GIRL-TRW	1	57	25/Ø288		X374607	X374608
		02.2004	08.2007	ATE	2	36	10/Ø290		X225313	X225314
C 230 (203.252)		01.2005	08.2007	BREMBO	2	57	28/Ø330		X284121	X284122
		01.2005	08.2007	GIRL-TRW	1	57	28/Ø300		X374605	X374606
		01.2005	08.2007	ATE	2	36	10/Ø290		X225313	X225314
C 230 Kompressor (203.240)		02.2004	08.2007	BREMBO	2	57	28/Ø330		X284121	X284122
		02.2004		BREMBO	4	40/44	28/Ø330		X284245	X284246
		02.2004	07.2005	GIRL-TRW	1	57	28/Ø300		X374605	X374606
		02.2004	07.2005	ATE	2	36	10/Ø290		X225313	X225314
C 240 (203.261, 203.061)		03.2001	08.2007	BREMBO	2	57	28/Ø330		X284121	X284122
		03.2001	04.2004	BREMBO	4	40/44	28/Ø330		X284245	X284246
		03.2001	12.2005	GIRL-TRW	1	57	28/Ø300		X374605	X374606
		03.2001	12.2005	ATE	2	36	10/Ø290		X225313	X225314
C 240 4-matic (203.281, 203.081)		07.2002	12.2005	GIRL-TRW	1	57	28		X374719	X374720
		07.2002	12.2005	ATE	2	36	10/Ø290		X225313	X225314
C 270 CDI (203.216)		03.2001	08.2007	BREMBO	2	57	28/Ø330		X284121	X284122
		03.2001	04.2004	BREMBO	4	40/44	28/Ø330		X284245	X284246
		03.2001	12.2004	GIRL-TRW	1	57	28/Ø300		X374605	X374606
		03.2001	12.2004	ATE	2	36	10/Ø290		X225313	X225314

Affectations par Marques

Vehicule application - Zuordnung nach Marke und Fahrzeuge - Applicazione per marca e veicolo - Aplicacion por marca y vehiculo



MERCEDES-BENZ

CLASSE C T-Model (S203)

C 280 (203.254)		01.2005	08.2007	BREMBO	2	57	28/Ø330		X284121	X284122
		01.2005	08.2007	GIRL-TRW	1	57	28/Ø300		X374605	X374606
		01.2005	08.2007	ATE	2	36	10/Ø290		X225313	X225314
C 280 4-matic (203.292)		01.2005	08.2007	BREMBO	2	57	28/Ø330		X284121	X284122
		01.2005	08.2007	GIRL-TRW	1	57	28		X374719	X374720
		01.2005	08.2007	ATE	2	36	10/Ø290		X225313	X225314
C 30 CDI AMG (203.218)		01.2003	12.2004	BREMBO	4	40/44	30/Ø345		X284221	X284222
C 32 AMG Kompressor (203.265)		03.2001	12.2004	BREMBO	4	40/44	30/Ø345		X284221	X284222
C 320 (203.264, 203.064, 203.764)		03.2001	08.2007	BREMBO	2	57	28/Ø330		X284121	X284122
		03.2001	04.2004	BREMBO	4	40/44	28/Ø330		X284245	X284246
		03.2001	07.2005	GIRL-TRW	1	57	28/Ø300		X374605	X374606
		03.2001	07.2005	ATE	2	36	10/Ø290		X225313	X225314
C 320 4-matic (203.284, 203.084)		07.2002	07.2005	GIRL-TRW	1	57	28		X374719	X374720
		07.2002	07.2005	ATE	2	36	10/Ø290		X225313	X225314
C 320 CDI (203.220)		06.2005	08.2007	BREMBO	2	57	28/Ø330		X284121	X284122
		06.2005	08.2007	BREMBO	4	40/44	30/Ø345		X284221	X284222
		06.2005	08.2007	ATE	2	36	10/Ø290		X225313	X225314
C 350 (203.256)		01.2005	08.2007	BREMBO	2	57	28/Ø330		X284121	X284122
		01.2005	08.2007	BREMBO	4	40/44	30/Ø345		X284221	X284222
		01.2005	08.2007	ATE	2	36	10/Ø290		X225313	X225314
C 350 4-matic (203.287)		01.2005	08.2007	BREMBO	4	40/44	30/Ø345		X284221	X284222
		01.2005	08.2007	ATE	2	36	10/Ø290		X225313	X225314
		01.2005	08.2007	ATE	2	42	20/Ø300		X225165	X225166
C 55 AMG (203.276)		02.2004	08.2007	BREMBO	4	40/44	30/Ø345		X284221	X284222

CLASSE C T-Model (S204)

C 180 CDI (204.200)		01.2011	01.2014	GIRL-TRW	1	60	25/Ø285		X374739	X374740
		01.2011	01.2014	GIRL-TRW	1	60	28/Ø295		X374771	X374772
		01.2011	01.2014	ATE	1	38	10		X225385	X225386
		01.2011	01.2014	ATE	1	38	9		X225383	X225384
C 180 CGI (204.231)		02.2012	01.2014	GIRL-TRW	1	60	25/Ø285		X374739	X374740
		02.2012	01.2014	GIRL-TRW	1	60	28/Ø295		X374771	X374772
		02.2012	01.2014	ATE	1	38	10		X225385	X225386
C 180 CGI (204.249)		11.2009	01.2014	GIRL-TRW	1	60	25/Ø285		X374739	X374740
		11.2009	01.2014	GIRL-TRW	1	60	28/Ø295		X374771	X374772
		11.2009	01.2014	ATE	1	38	10		X225385	X225386
		11.2009	01.2014	ATE	1	38	9		X225383	X225384
C 180 Kompressor (204.245)		01.2008	01.2014	GIRL-TRW	1	60	25/Ø285		X374739	X374740
		01.2008	01.2014	GIRL-TRW	1	60	28/Ø295		X374771	X374772
		01.2008	01.2014	ATE	1	38	10		X225385	X225386
		01.2008	01.2014	ATE	1	38	9		X225383	X225384

Affectations par Marques

Vehicule application - Zuordnung nach Marke und Fahrzeuge - Applicazione per marca e veicolo - Aplicacion por marca y vehiculo



MERCEDES-BENZ

CLASSE C T-Model (S204)

C 180 Kompressor (204.246)		08.2007	01.2014	GIRL-TRW	1	60	25/Ø285		X374739	X374740
		08.2007	01.2014	GIRL-TRW	1	60	28/Ø295		X374771	X374772
		08.2007	01.2014	ATE	1	38	10		X225385	X225386
		08.2007	01.2014	ATE	1	38	9		X225383	X225384
C 200 CDI (204.201)		08.2010	01.2014	GIRL-TRW	1	60	25/Ø285		X374739	X374740
		08.2010	01.2014	GIRL-TRW	1	60	28/Ø295		X374771	X374772
		08.2010	01.2014	ATE	1	38	10		X225385	X225386
		08.2010	01.2014	ATE	1	38	9		X225383	X225384
C 200 CDI (204.207)		08.2007		GIRL-TRW	1	60	25/Ø285		X374739	X374740
		08.2007		GIRL-TRW	1	60	28/Ø295		X374771	X374772
		08.2007		ATE	1	38	10		X225385	X225386
		08.2007		ATE	1	38	9		X225383	X225384
C 200 CGI (204.248)		08.2007	01.2014	GIRL-TRW	1	60	28/Ø295		X374771	X374772
		08.2007	01.2014	ATE	1	38	10		X225385	X225386
		08.2007	01.2014	ATE	1	38	9		X225383	X225384
C 200 Kompressor (204.241)		08.2007	01.2014	GIRL-TRW	1	60	28/Ø295		X374771	X374772
		08.2007	01.2014	ATE	1	38	10		X225385	X225386
		08.2007	01.2014	ATE	1	38	9		X225383	X225384
C 220 CDI		01.2007	01.2014	GIRL-TRW	1	60	28/Ø295		X374771	X374772
		01.2007	01.2014	ATE	1	38	10		X225385	X225386
		01.2007	01.2014	ATE	1	38	9		X225383	X225384
C 220 CDI (204.202)		12.2008	01.2014	GIRL-TRW	1	60	28/Ø295		X374771	X374772
		12.2008	01.2014	ATE	1	38	10		X225385	X225386
		12.2008	01.2014	ATE	1	38	9		X225383	X225384
C 220 CDI (204.208)		08.2007		GIRL-TRW	1	60	28/Ø295		X374771	X374772
		08.2007		ATE	1	38	10		X225385	X225386
		08.2007		ATE	1	38	9		X225383	X225384
C 220 CDI 4-matic (204.284)		02.2013		ATE	1	38	10		X225385	X225386
		02.2013		ATE	1	38	9		X225383	X225384
C 230 (204.252)		08.2007		GIRL-TRW	1	60	28/Ø295		X374771	X374772
		08.2007		ATE	1	38	10		X225385	X225386
		08.2007		ATE	1	38	9		X225383	X225384
C 250 CDI (204.203)		01.2009		GIRL-TRW	1	60	28/Ø295		X374771	X374772
		01.2009		ATE	1	40	22		X225387	X225388
		01.2009		ATE	1	40	22		X225389	X225390
C 250 CDI 4-matic (204.282)		04.2010	01.2014	ATE	1	38	10		X225385	X225386
		04.2010	01.2014	ATE	1	38	9		X225383	X225384
		04.2010	01.2014	ATE	1	40	22		X225387	X225388
		04.2010	01.2014	ATE	1	40	22		X225389	X225390
C 250 CGI (204.247)		07.2009	01.2014	GIRL-TRW	1	60	28/Ø295		X374771	X374772
		07.2009	01.2014	ATE	1	38	10		X225385	X225386
		07.2009	01.2014	ATE	1	38	9		X225383	X225384

Affectations par Marques

Vehicule application - Zuordnung nach Marke und Fahrzeuge - Applicazione per marca e veicolo - Aplicacion por marca y vehiculo



MERCEDES-BENZ

CLASSE C T-Model (S204)

C 280 (204.254)		08.2007		GIRL-TRW	1	60	28/Ø295		X374771	X374772
		08.2007		ATE	1	38	10	[Al]	X225385	X225386
		08.2007		ATE	1	38	9	[Fe]	X225383	X225384
C 300		08.2007		GIRL-TRW	1	60	28/Ø295		X374771	X374772
		08.2007		ATE	1	38	10	[Al]	X225385	X225386
		08.2007		ATE	1	38	9	[Fe]	X225383	X225384
C 320 CDI (204.222)		08.2007		GIRL-TRW	1	60	32/Ø322		X374769	X374770
		08.2007		ATE	1	40	22	[Fe]	X225387	X225388
		08.2007		ATE	1	40	22	[Al]	X225389	X225390
C 320 CDI 4-matic (204.289)		08.2007		ATE	1	40	22	[Fe]	X225387	X225388
		08.2007		ATE	1	40	22	[Al]	X225389	X225390
C 350 (204.256)		08.2007		GIRL-TRW	1	60	32/Ø322		X374769	X374770
		08.2007		ATE	1	40	22	[Fe]	X225387	X225388
		08.2007		ATE	1	40	22	[Al]	X225389	X225390
C 350 CDI		08.2007		GIRL-TRW	1	60	32/Ø322		X374769	X374770
		08.2007		ATE	1	40	22	[Fe]	X225387	X225388
		08.2007		ATE	1	40	22	[Al]	X225389	X225390
C 350 CDI (204.223)		06.2011	01.2014	GIRL-TRW	1	60	32/Ø322		X374769	X374770
		06.2011	01.2014	ATE	1	40	22	[Fe]	X225387	X225388
		06.2011	01.2014	ATE	1	40	22	[Al]	X225389	X225390
C 350 CDI (204.225)		10.2009	01.2014	GIRL-TRW	1	60	32/Ø322		X374769	X374770
		10.2009	01.2014	ATE	1	40	22	[Fe]	X225387	X225388
		10.2009	01.2014	ATE	1	40	22	[Al]	X225389	X225390
C 350 CDI 4-matic (204.292)		10.2009	01.2014	ATE	1	40	22	[Fe]	X225387	X225388
		10.2009	01.2014	ATE	1	40	22	[Al]	X225389	X225390
C 350 CGI (204.257)		06.2011	01.2014	GIRL-TRW	1	60	32/Ø322		X374769	X374770
		06.2011	01.2014	ATE	1	40	22	[Al]	X225389	X225390

CLASSE CLC (CL203)

CLC 160 (203.731)		02.2009	06.2011	GIRL-TRW	1	57	25/Ø288		X374607	X374608
		02.2009	06.2011	ATE	2	36	9/Ø278		X225249	X225250
CLC 180 Kompressor (203.746)		05.2008	06.2011	GIRL-TRW	1	57	25/Ø288		X374607	X374608
		05.2008	06.2011	ATE	2	36	9/Ø278		X225249	X225250
CLC 200 CDI (203.707)		05.2008	06.2011	GIRL-TRW	1	57	25/Ø288		X374607	X374608
		05.2008	06.2011	ATE	2	36	9/Ø278		X225249	X225250
CLC 200 Kompressor (203.741)		05.2008	06.2011	GIRL-TRW	1	57	28/Ø300		X374605	X374606
		05.2008	06.2011	ATE	2	36	10/Ø290		X225313	X225314
CLC 220 CDI (203.708)		05.2008	06.2011	GIRL-TRW	1	57	25/Ø288		X374607	X374608
		05.2008	06.2011	ATE	2	36	9/Ø278		X225249	X225250
CLC 230 (203.752)		05.2008	06.2011	GIRL-TRW	1	57	28/Ø300		X374605	X374606
		05.2008	06.2011	ATE	2	36	10/Ø290		X225313	X225314
CLC 350 (203.756)		05.2008	06.2011	BREMBO	2	57	28/Ø330		X284121	X284122
		05.2008	06.2011	ATE	2	36	10/Ø290		X225313	X225314

X=1 : SNRA - X=2 : EAI - X=3 : SERA - X=4 : SEEAC - X=5 : NEOTO - X=6 : STARTCAR

Affectations par Marques

Vehicule application - Zuordnung nach Marke und Fahrzeuge - Applicazione per marca e veicolo - Aplicacion por marca y vehiculo



MERCEDES-BENZ

CLASSE E (A124)

E 200 (124.060)		06.1993	03.1998	GIRL-TRW	1	54	22		X374083	X374084
		06.1993	03.1998	ATE	2	38	9/Ø278		X225191	X225192
E 220 (124.062)		06.1993	07.1996	GIRL-TRW	1	54	22		X374083	X374084
		06.1993	07.1996	ATE	2	35	9/Ø258		X225125	X225126
		06.1993	03.1998	BENDIX	2	35	9		X255017	X255018
E 320 (124.066)		06.1993	07.1996	ATE	4	38/42	22		X224223	X224224
		06.1993	07.1996	ATE	4	42	25		X224253	X224254
		06.1993	07.1996	ATE	2	38	9/Ø278		X225191	X225192
E 36 AMG (124.066)		05.1994	07.1997	ATE	4	42	25		X224253	X224254
		05.1994	07.1997	ATE	2	38	9/Ø278		X225191	X225192

CLASSE E (A207)

E 200 (207.434)		03.2013		GIRL-TRW	1	60	28/Ø295		X374771	X374772
		03.2013		ATE	1	38	10	[Al]	X225385	X225386
E 200 CGI (207.448)		01.2010		GIRL-TRW	1	60	28/Ø295		X374771	X374772
		01.2010		ATE	1	38	10	[Al]	X225385	X225386
		01.2010		ATE	1	38	9	[Fe]	X225383	X225384
E 220 CDI (207.402)		02.2010		GIRL-TRW	1	60	28/Ø295		X374771	X374772
		02.2010		ATE	1	38	10	[Al]	X225385	X225386
		02.2010		ATE	1	38	9	[Fe]	X225383	X225384
E 220 CDI / BlueTEC (207.402, 207.401)		01.2010		GIRL-TRW	1	60	28/Ø295		X374771	X374772
		01.2010		ATE	1	38	10	[Al]	X225385	X225386
		01.2010		ATE	1	38	9	[Fe]	X225383	X225384
E 250 (207.436)		06.2013		GIRL-TRW	1	60	32/Ø322		X374769	X374770
		06.2013		ATE	1	38	10	[Al]	X225385	X225386
E 250 CDI / BlueTEC (207.403, 207.404)		01.2010		GIRL-TRW	1	60	32/Ø322		X374769	X374770
		01.2010		ATE	1	38	10	[Al]	X225385	X225386
		01.2010		ATE	1	38	9	[Fe]	X225383	X225384
		01.2010		ATE	1	40	22	[Fe]	X225387	X225388
E 250 CGI (207.447)		01.2010		GIRL-TRW	1	60	28/Ø295		X374771	X374772
		01.2010		ATE	1	38	10	[Al]	X225385	X225386
		01.2010		ATE	1	38	9	[Fe]	X225383	X225384
E 300 (207.455)		04.2011		GIRL-TRW	1	60	32/Ø322		X374769	X374770
		04.2011		ATE	1	40	22	[Al]	X225389	X225390
E 320 (207.462)		07.2014		GIRL-TRW	1	60	32/Ø344		X374773	X374774
E 350 (207.459)		04.2011		GIRL-TRW	1	60	32/Ø322		X374769	X374770
		04.2011		ATE	1	40	22	[Al]	X225389	X225390
E 350 BlueTEC (207.426)		06.2013		GIRL-TRW	1	60	32/Ø322		X374769	X374770
		06.2013		ATE	1	40	22	[Fe]	X225387	X225388
		06.2013		ATE	1	40	22	[Al]	X225389	X225390
E 350 CDI		04.2011		GIRL-TRW	1	60	32/Ø322		X374769	X374770
		04.2011		ATE	1	40	22	[Fe]	X225387	X225388
		04.2011		ATE	1	40	22	[Al]	X225389	X225390

X=1 : SNRA - X=2 : EAI - X=3 : SERA - X=4 : SEEAC - X=5 : NEOTO - X=6 : STARTCAR

Affectations par Marques

Vehicule application - Zuordnung nach Marke und Fahrzeuge - Applicazione per marca e veicolo - Aplicacion por marca y vehiculo



MERCEDES-BENZ

CLASSE E (A207)

E 350 CDI (207.422)		01.2010		GIRL-TRW	1	60	32/Ø322		X374769	X374770
		01.2010		ATE	1	40	22	Fe	X225387	X225388
		01.2010		ATE	1	40	22	Al	X225389	X225390
E 350 CGI (207.457)		01.2010		GIRL-TRW	1	60	32/Ø322		X374769	X374770
		01.2010		ATE	1	40	22	Fe	X225387	X225388
		01.2010		ATE	1	40	22	Al	X225389	X225390
E 400 (207.461)		07.2014		GIRL-TRW	1	60	32/Ø344		X374773	X374774
E 400 (207.465)		03.2013		GIRL-TRW	1	60	32/Ø344		X374773	X374774
		06.2013		ATE	1	40	22	Al	X225389	X225390
E 500		06.2013		ATE	1	40	22	Al	X225389	X225390
E 500 (207.472)		01.2010		GIRL-TRW	1	60	32/Ø344		X374773	X374774
		01.2010		ATE	1	40	22	Fe	X225387	X225388
		01.2010		ATE	1	40	22	Al	X225389	X225390
E 500 (207.473)		09.2011		ATE	1	40	22	Al	X225389	X225390
E 550		09.2011		ATE	1	40	22	Al	X225389	X225390

CLASSE E (C124)

E 200 (124.040)		06.1993	07.1996	GIRL-TRW	1	54	22		X374083	X374084
		06.1993	07.1996	ATE	2	35	9/Ø258		X225125	X225126
		06.1993	06.1997	BENDIX	2	35	9		X255017	X255018
E 220 (124.042)		06.1993	07.1996	GIRL-TRW	1	54	22		X374083	X374084
		06.1993	07.1996	ATE	2	35	9/Ø258		X225125	X225126
		06.1993	06.1997	BENDIX	2	35	9		X255017	X255018
E 320 (124.052)		06.1993	06.1994	ATE	4	^{38/42}	22		X224223	X224224
		06.1993	06.1997	ATE	4	42	25		X224253	X224254
		06.1993	07.1996	ATE	2	38	9/Ø278		X225191	X225192
E 36 AMG (124.052)		06.1993	06.1997	ATE	4	^{38/42}	22		X224223	X224224
		06.1993	06.1997	ATE	2	38	9/Ø278		X225191	X225192

CLASSE E (C207)

E 200 (207.334)		06.2013		GIRL-TRW	1	60	28/Ø295		X374771	X374772
		06.2013		ATE	1	38	10	Al	X225385	X225386
E 200 CGI (207.348)		01.2010		GIRL-TRW	1	60	28/Ø295		X374771	X374772
		01.2010		ATE	1	38	10	Al	X225385	X225386
		01.2010		ATE	1	38	9	Fe	X225383	X225384
E 220 CDI		07.2014		GIRL-TRW	1	60	28/Ø295		X374771	X374772
		07.2014		ATE	1	38	10	Al	X225385	X225386
		07.2014		ATE	1	38	9	Fe	X225383	X225384
E 220 CDI (207.302)		01.2010		GIRL-TRW	1	60	28/Ø295		X374771	X374772
		01.2010		ATE	1	38	10	Al	X225385	X225386
E 250 (207.336)		06.2013		GIRL-TRW	1	60	32/Ø322		X374769	X374770
		06.2013		ATE	1	38	10	Al	X225385	X225386

X=1 : SNRA - X=2 : EAI - X=3 : SERA - X=4 : SEEAC - X=5 : NEOTO - X=6 : STARTCAR

Affectations par Marques

Vehicule application - Zuordnung nach Marke und Fahrzeuge - Applicazione per marca e veicolo - Aplicacion por marca y vehiculo



MERCEDES-BENZ

CLASSE E (C207)

E 250 CDI (207.303)		01.2009		GIRL-TRW	1	60	32/Ø322		X374769	X374770
		01.2009		ATE	1	38	10		X225385	X225386
		01.2009		ATE	1	40	22		X225387	X225388
E 250 CGI (207.347)		01.2009		GIRL-TRW	1	60	28/Ø295		X374771	X374772
		01.2009		ATE	1	38	10		X225385	X225386
		01.2009		ATE	1	38	9		X225383	X225384
E 300		04.2011		GIRL-TRW	1	60	32/Ø322		X374769	X374770
		04.2011		ATE	1	40	22		X225389	X225390
E 320 (207.362)		07.2014		GIRL-TRW	1	60	32/Ø344		X374773	X374774
E 350 (207.356)		05.2011		GIRL-TRW	1	60	32/Ø322		X374769	X374770
		05.2011		ATE	1	40	22		X225387	X225388
		05.2011		ATE	1	40	22		X225389	X225390
E 350 (207.356, 207.456)		04.2011		GIRL-TRW	1	60	32/Ø322		X374769	X374770
		04.2011		ATE	1	40	22		X225389	X225390
E 350 4-matic (207.388)		02.2013		ATE	1	40	22		X225389	X225390
E 350 BlueTEC		03.2013		GIRL-TRW	1	60	32/Ø322		X374769	X374770
		03.2013		ATE	1	40	22		X225387	X225388
		03.2013		ATE	1	40	22		X225389	X225390
E 350 CDI		04.2011		GIRL-TRW	1	60	32/Ø322		X374769	X374770
		04.2011		ATE	1	40	22		X225387	X225388
		04.2011		ATE	1	40	22		X225389	X225390
E 350 CDI (207.322)		01.2009		GIRL-TRW	1	60	32/Ø322		X374769	X374770
		01.2009		ATE	1	40	22		X225387	X225388
		01.2009		ATE	1	40	22		X225389	X225390
E 350 CGI (207.357)		01.2009		GIRL-TRW	1	60	32/Ø322		X374769	X374770
		01.2009		ATE	1	40	22		X225387	X225388
		01.2009		ATE	1	40	22		X225389	X225390
E 400		06.2013		GIRL-TRW	1	60	32/Ø344		X374773	X374774
		06.2013		ATE	1	40	22		X225389	X225390
E 500 (207.372)		01.2009		ATE	1	40	22		X225387	X225388
		01.2009		ATE	1	40	22		X225389	X225390

CLASSE E (S124)

E 200 T (124.079)		06.1993	06.1996	GIRL-TRW	1	54	22		X374083	X374084
		06.1993	06.1996	ATE	2	38	9/Ø278		X225191	X225192
E 220 T (124.082)		06.1993	06.1996	GIRL-TRW	1	54	22		X374083	X374084
		06.1993	06.1996	ATE	2	35	9/Ø258		X225125	X225126
		06.1993	06.1996	BENDIX	2	35	9		X255017	X255018
E 250 T D (124.186)		06.1993	06.1995	ATE	1	54	12		X224147	X224148
		06.1993	06.1995	GIRL-TRW	1	54	12		X374131	X374132
		06.1993	06.1995	ATE	2	35	9/Ø258		X225125	X225126
		06.1993	06.1996	BENDIX	2	35	9		X255017	X255018

Affectations par Marques

Vehicule application - Zuordnung nach Marke und Fahrzeuge - Applicazione per marca e veicolo - Aplicacion por marca y vehiculo



MERCEDES-BENZ

CLASSE E (S124)

E 250 Turbo D		06.1993	06.1996	GIRL-TRW	1	54	22		X374083	X374084
		06.1993	06.1996	ATE	2	35	9/Ø258		X225125	X225126
		06.1993	06.1996	BENDIX	2	35	9		X255017	X255018
E 280 T (124.088)		06.1993	06.1996	GIRL-TRW	1	54	22		X374083	X374084
		06.1993	06.1996	ATE	2	35	9/Ø258		X225125	X225126
		06.1993	06.1996	BENDIX	2	35	9		X255017	X255018
E 280 T (124.088)		06.1993	06.1996	GIRL-TRW	1	54	22		X374083	X374084
		06.1993	06.1996	ATE	2	35	9/Ø258		X225125	X225126
		06.1993	06.1996	BENDIX	2	35	9		X255017	X255018
E 300 T 4-matic (124.290)		06.1993	06.1996	GIRL-TRW	1	54	22		X374169	X374170
		06.1993	06.1996	ATE	2	35	9/Ø258		X225125	X225126
		06.1993	06.1996	BENDIX	2	35	9		X255017	X255018
E 300 T D (124.191)		06.1993	06.1996	GIRL-TRW	1	54	22		X374083	X374084
		06.1993	06.1996	ATE	2	35	9/Ø258		X225125	X225126
		06.1993	06.1996	BENDIX	2	35	9		X255017	X255018
E 300 T Turbo-D (124.193)		06.1993	06.1996	GIRL-TRW	1	54	22		X374083	X374084
		06.1993	06.1996	ATE	2	35	9/Ø258		X225125	X225126
		06.1993	06.1996	BENDIX	2	35	9		X255017	X255018
E 300 T Turbo-D 4-matic (124.393)		06.1993	06.1996	GIRL-TRW	1	54	22		X374169	X374170
		06.1993	06.1996	ATE	2	35	9/Ø258		X225125	X225126
		06.1993	06.1996	BENDIX	2	35	9		X255017	X255018
E 320 T (124.092)		06.1993	06.1994	ATE	4	38/42	22		X224223	X224224
		06.1993	06.1996	ATE	4	42	25		X224253	X224254
		06.1993	06.1994	ATE	2	42	9		X225085	X225086
E 36 T AMG (124.092)		05.1994		ATE	4	38/42	22		X224223	X224224
		05.1994	06.1996	ATE	4	42	25		X224253	X224254
		05.1994	06.1996	ATE	2	42	9		X225085	X225086

CLASSE E (S210)

E 200 T (210.235)		06.1996	08.2000	ATE	1	57	25/Ø288		X224437	X224438
		06.1996	08.2000	ATE	2	40	12		X225091	X225092
E 200 T Kompressor (210.245)		06.1997	03.2003	ATE	1	57	28/Ø300		X224439	X224440
		06.1997	03.2003	ATE	2	40	12		X225091	X225092
E 200 T Kompressor (210.248)		08.2000	03.2003	ATE	1	57	25/Ø288		X224437	X224438
		08.2000	03.2003	ATE	2	40	12		X225091	X225092
E 220 T CDI (210.206)		06.1998	03.2003	ATE	1	57	25/Ø288		X224437	X224438
		06.1998	03.2003	ATE	2	40	12	2 axe pour plaquettes	X225091	X225092
		05.1999	03.2003	ATE	2	36	9	1 axe pour plaquettes	X225223	X225224
E 230 T (210.237)		06.1996	06.1997	ATE	1	57	25/Ø288		X224437	X224438
		06.1996	06.1997	ATE	2	40	12		X225091	X225092
E 240 T (210.261)		06.1997	03.2003	ATE	1	57	25/Ø288		X224437	X224438
		06.1997	03.2003	ATE	1	57	28/Ø300		X224439	X224440
		06.1997	03.2003	ATE	2	40	12		X225091	X225092

X=1 : SNRA - X=2 : EAI - X=3 : SERA - X=4 : SEEAC - X=5 : NEOTO - X=6 : STARTCAR

Affectations par Marques

Vehicule application - Zuordnung nach Marke und Fahrzeuge - Applicazione per marca e veicolo - Aplicacion por marca y vehiculo



MERCEDES-BENZ

CLASSE E (S210)

E 240 T (210.262)		08.2000	03.2003	ATE	1	57	25/Ø288		X224437	X224438
		08.2000	03.2003	ATE	2	40	12		X225091	X225092
E 250 T D (210.210)		06.1996	07.1998	ATE	1	57	25/Ø288		X224437	X224438
		06.1996	07.1998	ATE	2	40	12		X225091	X225092
E 250 T Turbo-D (210.215)		06.1997	07.1999	ATE	1	57	25/Ø288		X224437	X224438
		06.1997	07.1999	ATE	2	40	12		X225091	X225092
E 270 T CDI		02.2000	03.2003	ATE	1	57	28/Ø300		X224439	X224440
		02.2000	03.2003	ATE	2	40	12		X225091	X225092
E 270 T CDI (210.216)		07.1999	03.2003	ATE	1	57	28/Ø300		X224439	X224440
		07.1999	03.2003	ATE	2	40	12		X225091	X225092
E 280 T (210.263)		12.1996	03.2003	ATE	1	57	28/Ø300		X224439	X224440
		12.1996	03.2003	ATE	2	40	12		X225091	X225092
E 280 T 4-matic (210.281)		12.1996	03.2003	ATE	1	57	28/Ø300		X224439	X224440
		12.1996	03.2003	ATE	2	40	12		X225091	X225092
E 290 T Turbo-D (210.217)		06.1996	07.1999	ATE	1	57	25/Ø288		X224437	X224438
		06.1996	07.1999	ATE	2	40	12		X225091	X225092
E 300 T Turbo-D (210.225)		12.1996	07.1999	ATE	1	57	28/Ø300		X224439	X224440
		12.1996	07.1999	ATE	2	40	12		X225091	X225092
E 320 T (210.265)		12.1996	03.2003	ATE	1	57	28/Ø300		X224439	X224440
		12.1996	03.2003	ATE	2	40	12		X225091	X225092
E 320 T 4-matic (210.282)		12.1996	03.2003	ATE	1	57	28/Ø300		X224439	X224440
		12.1996	03.2003	ATE	2	40	12		X225091	X225092
E 320 T CDI (210.226)		07.1999	03.2003	ATE	1	57	28/Ø300		X224439	X224440
		07.1999	03.2003	ATE	2	40	12		X225091	X225092
E 420 T (210.272)		06.1996	06.1997	ATE	4	^{38/42}	28		X224667	X224668
		06.1996	06.1997	ATE	2	40	12		X225091	X225092
E 430 T (210.270)		06.1997	03.2003	ATE	2	44	32		X224885	X224886
		06.1997	03.2003	ATE	4	^{38/42}	28		X224667	X224668
		06.1997	03.2003	ATE	2	40	12		X225091	X225092
E 430 T 4-matic (210.283)		05.1999	03.2003	ATE	2	44	32		X224885	X224886
		05.1999	03.2003	ATE	2	44	32		X224885	X224886
E 55 T AMG (210.274)		08.1997	03.2003	ATE	2	46	22		X225251	X225252
		08.1997	03.2003	BENDIX	2	46	22		X255023	X255024
E 55 T AMG 4-matic (210.283)		03.2001	03.2003	ATE	2	46	22		X225251	X225252
		03.2001	03.2003	BENDIX	2	46	22		X255023	X255024

CLASSE E (W124)

E 200 (124.019)		06.1993	06.1995	GIRL-TRW	1	54	22		X374083	X374084
		06.1993	06.1995	ATE	2	35	9		X225125	X225126
		06.1993	06.1995	BENDIX	2	35	9		X255017	X255018
E 200 D (124.120)		06.1993	06.1995	ATE	1	54	12		X224147	X224148
		06.1993	06.1995	GIRL-TRW	1	54	12		X374131	X374132
		06.1993	06.1995	ATE	2	35	9		X225125	X225126
		06.1993	06.1995	BENDIX	2	35	9		X255017	X255018

X=1 : SNRA - X=2 : EAI - X=3 : SERA - X=4 : SEEAC - X=5 : NEOTO - X=6 : STARTCAR

Affectations par Marques

Vehicule application - Zuordnung nach Marke und Fahrzeuge - Applicazione per marca e veicolo - Aplicacion por marca y vehiculo



MERCEDES-BENZ

CLASSE E (W124)

E 220 (124.022)		06.1993	06.1995	GIRL-TRW	1	54	22		X374083	X374084
		06.1993	06.1995	ATE	2	35	9		X225125	X225126
		06.1993	06.1995	BENDIX	2	35	9		X255017	X255018
E 250 D (124.126, 124.129)		07.1993	06.1995	ATE	1	54	12		X224147	X224148
		07.1993	06.1995	GIRL-TRW	1	54	12		X374131	X374132
		07.1993	06.1995	ATE	2	35	9		X225125	X225126
		07.1993	06.1995	BENDIX	2	35	9		X255017	X255018
E 250 Turbo-D (124.128)		06.1993	06.1995	GIRL-TRW	1	54	22		X374083	X374084
		06.1993	06.1995	ATE	2	35	9		X225125	X225126
		06.1993	06.1995	BENDIX	2	35	9		X255017	X255018
E 280 (124.028)		06.1993	06.1995	GIRL-TRW	1	54	22		X374083	X374084
		06.1993	06.1995	ATE	2	35	9		X225125	X225126
		06.1993	06.1995	BENDIX	2	35	9		X255017	X255018
E 280 (124.029)		06.1993	06.1995	GIRL-TRW	1	54	22		X374083	X374084
		06.1993	06.1995	ATE	2	35	9		X225125	X225126
		06.1993	06.1995	BENDIX	2	35	9		X255017	X255018
E 300 4-matic (124.230)		06.1993	06.1995	GIRL-TRW	1	54	22		X374169	X374170
		06.1993	06.1995	ATE	2	35	9		X225125	X225126
		06.1993	06.1995	BENDIX	2	35	9		X255017	X255018
E 300 D (124.131)		07.1993	06.1995	ATE	1	54	12		X224147	X224148
		07.1993	06.1995	GIRL-TRW	1	54	12		X374131	X374132
		07.1993	06.1995	ATE	2	35	9		X225125	X225126
		07.1993	06.1995	BENDIX	2	35	9		X255017	X255018
E 300 Turbo-D (124.133)		06.1993	06.1995	GIRL-TRW	1	54	22		X374083	X374084
		06.1993	06.1995	ATE	2	35	9		X225125	X225126
		06.1993	06.1995	BENDIX	2	35	9		X255017	X255018
E 300 Turbo-D 4-matic (124.333)		06.1993	06.1995	GIRL-TRW	1	54	22		X374169	X374170
		06.1993	06.1995	ATE	2	35	9		X225125	X225126
		06.1993	06.1995	BENDIX	2	35	9		X255017	X255018
E 320 (124.032)		06.1993	06.1994	ATE	4	^{38/42}	22		X224223	X224224
		06.1993	06.1995	ATE	4	42	25		X224253	X224254
		06.1993	06.1995	ATE	2	35	9		X225125	X225126
		06.1993	06.1995	BENDIX	2	35	9		X255017	X255018
E 36 AMG		07.1994	01.1995	ATE	4	^{38/42}	22		X224223	X224224
		07.1994	01.1995	ATE	4	42	25		X224253	X224254
		07.1994	01.1995	ATE	2	35	9		X225125	X225126
		07.1994	01.1995	BENDIX	2	35	9		X255017	X255018
E 420 (124.034)		06.1993	06.1995	ATE	2	57	28		X224251	X224252
		06.1993	06.1994	ATE	4	42	25		X224253	X224254
		06.1993	06.1995	GIRL-TRW	4	^{40/44}	28		X374259	X374260
E 500 (124.036)		06.1993	06.1995	ATE	2	57	28		X224251	X224252
		06.1993	06.1995	GIRL-TRW	4	^{40/44}	28		X374259	X374260
		06.1993	06.1995	ATE	2	42	20/Ø300		X225165	X225166

Affectations par Marques

Vehicule application - Zuordnung nach Marke und Fahrzeuge - Applicazione per marca e veicolo - Aplicacion por marca y vehiculo



MERCEDES-BENZ

CLASSE E (W124)

E 60 AMG (124.036)		05.1994	06.1995	ATE	2	57	28		X224251	X224252
		05.1994	06.1995	GIRL-TRW	4	40/44	28		X374259	X374260
		05.1994	06.1995	ATE	2	42	20/Ø300		X225165	X225166

CLASSE E (W210)

E 200 (210.035)		06.1995	08.2000	ATE	1	57	25/Ø288		X224437	X224438
		06.1995	08.2000	ATE	2	36	9	1 axe pour plaquettes	X225223	X225224
		06.1995	05.1999	ATE	2	38	9	2 axe pour plaquettes	X225191	X225192
E 200 CDI (210.007)		06.1998	03.2002	ATE	1	57	25/Ø288		X224437	X224438
		06.1998	03.2002	ATE	2	36	9	1 axe pour plaquettes	X225223	X225224
E 200 D (210.003)		01.1996	06.2000	ATE	1	57	25/Ø288		X224437	X224438
		01.1996	03.2002	ATE	2	36	9	1 axe pour plaquettes	X225223	X225224
		01.1996	05.1999	ATE	2	38	9	2 axe pour plaquettes	X225191	X225192
E 200 Kompressor (210.045)		06.1997	06.2000	ATE	1	57	28/Ø300		X224439	X224440
		06.1997	05.1999	ATE	2	36	10	1 axe pour plaquettes	X225287	X225288
		06.1997	03.2002	ATE	2	36	9	1 axe pour plaquettes	X225223	X225224
E 200 Kompressor (210.048)		08.2000	03.2002	ATE	1	57	25/Ø288		X224437	X224438
		08.2000	03.2002	ATE	2	36	9	1 axe pour plaquettes	X225223	X225224
E 220 CDI		07.1999	03.2002	ATE	1	57	25/Ø288		X224437	X224438
		07.1999	03.2002	ATE	2	36	9	1 axe pour plaquettes	X225223	X225224
E 220 CDI (210.006)		06.1998	03.2002	ATE	1	57	25/Ø288		X224437	X224438
		06.1998	03.2002	ATE	2	36	9	1 axe pour plaquettes	X225223	X225224
E 220 D		05.1996	05.1998	ATE	1	57	25/Ø288		X224437	X224438
		05.1996	05.1998	ATE	2	38	9	2 axe pour plaquettes	X225191	X225192
E 220 D (210.004)		06.1995	05.1998	ATE	1	57	25/Ø288		X224437	X224438
		06.1995	05.1998	ATE	2	38	9	2 axe pour plaquettes	X225191	X225192
E 230 (210.037)		06.1995	06.1997	ATE	1	57	25/Ø288		X224437	X224438
		06.1995	06.1997	ATE	2	36	9	1 axe pour plaquettes	X225223	X225224
		06.1995	06.1997	ATE	2	38	9	2 axe pour plaquettes	X225191	X225192
E 240 (210.061)		06.1997	08.2000	ATE	1	57	25/Ø288		X224437	X224438
		06.1997	08.2000	ATE	1	57	28/Ø300		X224439	X224440
		06.1997	05.1999	ATE	2	36	10	2 axe pour plaquettes	X225221	X225222
		06.1997	05.1999	ATE	2	36	10	1 axe pour plaquettes	X225287	X225288
		06.1997	08.2000	ATE	2	36	9	1 axe pour plaquettes	X225223	X225224
		06.1997	05.1999	ATE	2	38	9	2 axe pour plaquettes	X225191	X225192
E 240 (210.062)		08.2000	03.2002	ATE	1	57	25/Ø288		X224437	X224438
		08.2000	03.2002	ATE	2	36	9	1 axe pour plaquettes	X225223	X225224
E 250 D (210.010)		06.1995	07.1999	ATE	1	57	25/Ø288		X224437	X224438
		06.1995	07.1999	ATE	2	36	9	1 axe pour plaquettes	X225223	X225224
		06.1995	07.1999	ATE	2	38	9	2 axe pour plaquettes	X225191	X225192
E 250 Turbo-D (210.015)		06.1997	07.1999	ATE	1	57	25/Ø288		X224437	X224438
		06.1997	07.1999	ATE	2	36	9	1 axe pour plaquettes	X225223	X225224
E 270 CDI		07.1999	03.2002	ATE	1	57	28/Ø300		X224439	X224440
		07.1999	03.2002	ATE	2	36	10	1 axe pour plaquettes	X225287	X225288

X=1 : SNRA - X=2 : EAI - X=3 : SERA - X=4 : SEEC - X=5 : NEOTO - X=6 : STARTCAR

Affectations par Marques

Vehicule application - Zuordnung nach Marke und Fahrzeuge - Applicazione per marca e veicolo - Aplicacion por marca y vehiculo



MERCEDES-BENZ

CLASSE E (W210)

E 270 CDI (210.016)		07.1999	03.2002	ATE	1	57	28/Ø300		X224439	X224440
		07.1999	03.2002	ATE	2	36	10	1 axe pour plaquettes	X225287	X225288
E 280 (210.053)		01.1996	06.1997	ATE	1	57	28/Ø300		X224439	X224440
		01.1996	06.1997	ATE	2	36	10	2 axe pour plaquettes	X225221	X225222
		01.1996	06.1997	ATE	2	36	10	1 axe pour plaquettes	X225287	X225288
E 280 (210.063)		12.1996	03.2002	ATE	1	57	28/Ø300		X224439	X224440
		12.1996	03.2002	ATE	2	36	10	2 axe pour plaquettes	X225221	X225222
		12.1996	03.2002	ATE	2	36	10	1 axe pour plaquettes	X225287	X225288
E 280 4-matic (210.081)		12.1996	03.2002	ATE	1	57	28/Ø300		X224439	X224440
		12.1996	03.2002	ATE	2	36	10	2 axe pour plaquettes	X225221	X225222
		12.1996	03.2002	ATE	2	36	10	1 axe pour plaquettes	X225287	X225288
E 290 Turbo-D (210.017)		03.1996	07.1999	ATE	1	57	25/Ø288		X224437	X224438
		03.1996	07.1999	ATE	2	36	9	1 axe pour plaquettes	X225223	X225224
		03.1996	07.1999	ATE	2	38	9	2 axe pour plaquettes	X225191	X225192
E 300 D (210.020)		06.1995	06.1997	ATE	1	57	25/Ø288		X224437	X224438
		06.1995	06.1997	ATE	2	36	9	1 axe pour plaquettes	X225223	X225224
		06.1995	06.1997	ATE	2	38	9	2 axe pour plaquettes	X225191	X225192
E 300 Turbo-D (210.025)		12.1996	07.1999	ATE	1	57	28/Ø300		X224439	X224440
		12.1996	07.1999	ATE	2	36	10	2 axe pour plaquettes	X225221	X225222
		12.1996	07.1999	ATE	2	36	10	1 axe pour plaquettes	X225287	X225288
E 320 (210.055)		06.1995	06.1997	ATE	1	57	28/Ø300		X224439	X224440
		06.1995	05.1999	ATE	2	36	10	2 axe pour plaquettes	X225221	X225222
E 320 (210.065)		06.1997	03.2002	ATE	1	57	28/Ø300		X224439	X224440
		06.1997	03.2002	ATE	2	36	10	1 axe pour plaquettes	X225287	X225288
E 320 4-matic (210.082)		06.1997	03.2002	ATE	1	57	28/Ø300		X224439	X224440
		06.1997	03.2002	ATE	2	36	10	1 axe pour plaquettes	X225287	X225288
		06.1997	05.1999	ATE	2	36	10	2 axe pour plaquettes	X225221	X225222
E 320 CDI (210.026)		07.1999	03.2002	ATE	1	57	28/Ø300		X224439	X224440
		07.1999	03.2002	ATE	2	36	10	1 axe pour plaquettes	X225287	X225288
E 420 (210.072)		01.1996	06.1997	ATE	2	44	32/Ø330		X224897	X224898
		01.1996	06.1997	ATE	4	38/42	28		X224667	X224668
		01.1996	06.1997	ATE	2	36	10	2 axe pour plaquettes	X225221	X225222
		01.1996	06.1997	ATE	2	36	10	1 axe pour plaquettes	X225287	X225288
E 430 (210.070)		06.1997	03.2002	ATE	2	44	32		X224885	X224886
		06.1997	03.2002	ATE	2	44	32/Ø330		X224897	X224898
		06.1997	05.1999	ATE	4	38/42	28		X224667	X224668
		06.1997	05.1999	ATE	2	36	10	2 axe pour plaquettes	X225221	X225222
		06.1997	05.1999	ATE	2	36	10	1 axe pour plaquettes	X225287	X225288
		06.1997	03.2002	ATE	2	42	20/Ø300		X225165	X225166
E 430 4-matic (210.083)		05.1999	03.2002	ATE	2	44	32		X224885	X224886
		05.1999	03.2002	ATE	2	44	32/Ø330		X224897	X224898
		05.1999	03.2002	ATE	2	42	20/Ø300		X225165	X225166
E 50 AMG (210.072)		02.1996	08.1997	ATE	2	42	20/Ø300		X225165	X225166

X=1 : SNRA - X=2 : EAI - X=3 : SERA - X=4 : SEEAC - X=5 : NEOTO - X=6 : STARTCAR

Affectations par Marques

Vehicule application - Zuordnung nach Marke und Fahrzeuge - Applicazione per marca e veicolo - Aplicacion por marca y vehiculo



MERCEDES-BENZ

CLASSE E (W210)

E 55 AMG (210.074)		08.1997	03.2002	ATE	2	42	20/Ø300		X225165	X225166
E 55 AMG 4-matic (210.074)		03.2001	03.2002	ATE	2	42	20/Ø300		X225165	X225166

CLASSE E (W211)

E 200 CDI (211.004)		07.2002	12.2008	BOSCH	1	60	28		X274067	X274068
		07.2002	12.2008	BREMBO	4	44	32/Ø330		X284243	X284244
E 200 CDI (211.007)		04.2006	12.2008	BOSCH	1	60	28		X274067	X274068
		04.2006	12.2008	BREMBO	4	44	32/Ø330		X284243	X284244
E 200 CGI		11.2002	12.2008	BOSCH	1	60	28		X274067	X274068
		11.2002	12.2008	BREMBO	4	40/44	32/Ø330		X284157	X284158
E 200 Kompressor (211.041)		04.2006	12.2008	BOSCH	1	60	28		X274067	X274068
		04.2006	12.2008	BREMBO	4	44	32/Ø330		X284243	X284244
E 200 Kompressor (211.042)		11.2002	07.2006	BOSCH	1	60	28		X274067	X274068
		11.2002	07.2006	BREMBO	4	40/44	32/Ø330		X284157	X284158
E 200 NGT (211.041)		03.2004	12.2008	BOSCH	1	60	28		X274067	X274068
		03.2004	12.2008	BREMBO	4	44	32/Ø330		X284243	X284244
E 220 CDI		03.2003	12.2008	BOSCH	1	60	28		X274067	X274068
		03.2003	12.2008	BREMBO	4	44	32/Ø330		X284243	X284244
E 220 CDI (211.006)		03.2002	07.2006	BOSCH	1	60	28		X274067	X274068
		03.2002	07.2006	BREMBO	4	44	32/Ø330		X284243	X284244
E 220 CDI (211.008)		04.2006	12.2008	BOSCH	1	60	28		X274067	X274068
		04.2006	12.2008	BREMBO	4	44	32/Ø330		X284243	X284244
E 230 (211.052)		09.2007	12.2008	BOSCH	1	60	28		X274067	X274068
		09.2007	12.2008	BREMBO	4	44	32/Ø330		X284243	X284244
E 240 (211.061)		03.2002	07.2006	BOSCH	1	60	28		X274067	X274068
E 270 CDI (211.016)		03.2002	07.2005	BOSCH	1	60	28		X274067	X274068
E 280 (211.054)		03.2005	12.2008	BOSCH	1	60	28		X274067	X274068
		03.2005	12.2008	BREMBO	4	44	32/Ø330		X284243	X284244
E 280 4-matic (211.092)		01.2006	12.2008	ATE	2	44	32		X224775	X224776
E 280 CDI (211.020)		03.2005	12.2008	BOSCH	1	60	28		X274067	X274068
		03.2005	06.2006	BREMBO	4	40/44	32/Ø330		X284157	X284158
		03.2005	12.2008	BREMBO	4	44	32/Ø330		X284243	X284244
E 280 CDI (211.023)		05.2004	07.2005	BOSCH	1	60	28		X274067	X274068
		05.2004	07.2005	BREMBO	4	40/44	32/Ø330		X284157	X284158
E 280 CDI 4-matic		03.2005	12.2008	ATE	2	44	32		X224775	X224776
E 300 BlueTEC		09.2007	12.2008	BOSCH	1	60	28		X274067	X274068
		09.2007	12.2008	BREMBO	4	40/44	32/Ø330		X284157	X284158
E 320 (211.065)		03.2002	12.2008	BOSCH	1	60	28		X274067	X274068
		03.2002	09.2003	BREMBO	4	40/44	28		X284195	X284196
		03.2002	07.2004	BREMBO	4	40/44	32/Ø330		X284157	X284158
E 320 CDI (211.022)		03.2005	12.2008	BOSCH	1	60	28		X274067	X274068
		03.2005	12.2008	BREMBO	4	40/44	32/Ø330		X284157	X284158
		03.2005	12.2008	BREMBO	4	44	32/Ø330		X284243	X284244

Affectations par Marques

Vehicule application - Zuordnung nach Marke und Fahrzeuge - Applicazione per marca e veicolo - Aplicacion por marca y vehiculo



MERCEDES-BENZ

CLASSE E (W211)

E 320 CDI (211.026)		11.2002	12.2008	BOSCH	1	60	28		X274067	X274068
		11.2002	09.2003	BREMBO	4	40/44	28		X284195	X284196
		11.2002	07.2006	BREMBO	4	40/44	32/Ø330		X284157	X284158
E 320 CDI 4-matic		03.2005	12.2008	ATE	2	44	32		X224679	X224680
		03.2005	12.2008	ATE	2	44	32		X224775	X224776
E 350 (211.056)		03.2005	12.2008	BOSCH	1	60	28		X274067	X274068
		03.2005	12.2008	BREMBO	4	44	32/Ø330		X284243	X284244
E 350 4-matic (211.087)		03.2005		ATE	2	44	32		X224679	X224680
		03.2005	12.2008	ATE	2	44	32		X224775	X224776
E 350 CGI (211.057)		09.2007	12.2008	BOSCH	1	60	28		X274067	X274068
		09.2007	12.2008	BREMBO	4	44	32/Ø330		X284243	X284244
E 400 CDI (211.028)		02.2003	07.2005	BREMBO	4	40/44	32/Ø330		X284157	X284158
E 420 CDI (211.029)		01.2006	12.2008	BREMBO	4	44	32		X284109	X284110
E 500 (211.070)		03.2002	06.2005	BREMBO	4	40/44	32/Ø330		X284157	X284158
E 500 (211.072)		04.2006	12.2008	BREMBO	4	44	32		X284109	X284110
E 500 4-matic (211.083)		10.2003	10.2004	ATE	2	44	32		X224885	X224886
		10.2003	12.2008	ATE	2	44	32		X224679	X224680
		10.2003	12.2008	ATE	2	44	32		X224775	X224776
E 500 4-matic (211.090)		04.2006		ATE	2	44	32		X224679	X224680
		04.2006	12.2008	ATE	2	44	32		X224775	X224776
Tout / All / Alle / Tutti / Todos		03.2002	12.2008	ATE	1	42	11		X225331	X225332
		03.2002	12.2008	ATE	1	42	22		X225311	X225312

CLASSE E (W212)

E 200 (212.034)		01.2013	12.2015	GIRL-TRW	1	60	28/Ø295		X374771	X374772
E 200 CDI / BlueTEC (212.005, 212.006)		01.2009	12.2015	GIRL-TRW	1	60	28/Ø295		X374771	X374772
E 200 CGI (212.048, 212.148)		08.2009	12.2015	GIRL-TRW	1	60	28/Ø295		X374771	X374772
		08.2009	12.2015	GIRL-TRW	1	60	32/Ø322		X374769	X374770
E 200 NGT (212.035)		07.2013	12.2015	GIRL-TRW	1	60	28/Ø295		X374771	X374772
E 200 NGT (212.041)		03.2011	12.2015	GIRL-TRW	1	60	28/Ø295		X374771	X374772
E 220 CDI		01.2009	12.2015	GIRL-TRW	1	60	28/Ø295		X374771	X374772
E 220 CDI / BlueTEC (212.001, 212.002)		01.2009	12.2015	GIRL-TRW	1	60	28/Ø295		X374771	X374772
E 250 (212.036)		01.2013	12.2015	GIRL-TRW	1	60	32/Ø322		X374769	X374770
E 250 CDI / BlueTEC (212.003, 212.004)		01.2009	12.2015	GIRL-TRW	1	60	32/Ø322		X374769	X374770
E 250 CDI BlueTEC 4-matic (212.082, 212.083)		01.2009	12.2015	GIRL-TRW	1	60	28/Ø295		X374771	X374772
E 250 CGI (212.047, 212.147)		01.2009	12.2015	GIRL-TRW	1	60	32/Ø322		X374769	X374770
E 300 (212.054)		01.2009	12.2015	GIRL-TRW	1	60	32/Ø322		X374769	X374770
E 300 (212.055)		07.2011	12.2015	GIRL-TRW	1	60	32/Ø322		X374769	X374770
E 300 CDI (212.020)		03.2011	12.2015	GIRL-TRW	1	60	32/Ø322		X374769	X374770
E 300 CDI / BlueTEC (212.020, 212.021)		03.2011	12.2015	GIRL-TRW	1	60	32/Ø322		X374769	X374770
E 300 Hybrid / BlueTEC Hybrid (212.098)		12.2011	12.2015	GIRL-TRW	1	60	32/Ø322		X374769	X374770
E 350 (212.056)		01.2009	12.2015	GIRL-TRW	1	60	32/Ø322		X374769	X374770
E 350 (212.059)		09.2011	12.2015	GIRL-TRW	1	60	32/Ø322		X374769	X374770

X=1 : SNRA - X=2 : EAI - X=3 : SERA - X=4 : SEEC - X=5 : NEOTO - X=6 : STARTCAR

Affectations par Marques

Vehicule application - Zuordnung nach Marke und Fahrzeuge - Applicazione per marca e veicolo - Aplicacion por marca y vehiculo



MERCEDES-BENZ

CLASSE E (W212)

E 350 BlueTEC		11.2012	12.2015	BREMBO	4	44	32		X284239	X284240
E 350 BlueTEC (212.024)		01.2009	12.2015	GIRL-TRW	1	60	32/Ø322		X374769	X374770
E 350 CDI (212.023)		03.2011	12.2015	GIRL-TRW	1	60	32/Ø322		X374769	X374770
E 350 CDI (212.025)		01.2009	12.2015	GIRL-TRW	1	60	32/Ø322		X374769	X374770
E 350 CGI (212.057)		01.2009	08.2011	GIRL-TRW	1	60	32/Ø322		X374769	X374770
E 400 (212.065)		01.2013	12.2015	BREMBO	4	44	32		X284239	X284240
E 500 (212.072)		01.2009	12.2015	BREMBO	4	44	32		X284239	X284240
Tout / All / Alle / Tutti / Todos		01.2009	12.2015	ATE	1	42	22		X225437	X225438

CLASSE E T-Model (S211)

350 CGI (211.257)		05.2006	07.2009	BOSCH	1	60	28		X274067	X274068
		05.2006	07.2009	BREMBO	4	44	32/Ø330		X284243	X284244
E 200 CDI (211.207)		04.2006	07.2009	BOSCH	1	60	28		X274067	X274068
		04.2006	07.2009	BREMBO	4	44	32/Ø330		X284243	X284244
E 200 Kompressor (211.241)		04.2006	07.2009	BOSCH	1	60	28		X274067	X274068
		04.2006	07.2009	BREMBO	4	44	32/Ø330		X284243	X284244
E 200 T Kompressor (211.242)		03.2003	07.2006	BOSCH	1	60	28		X274067	X274068
		03.2003	06.2005	BREMBO	4	^{40/44}	32/Ø330		X284157	X284158
		03.2003	07.2009	BREMBO	4	44	32/Ø330		X284243	X284244
E 220 CDI (211.206)		03.2003	07.2009	BOSCH	1	60	28		X274067	X274068
		03.2003	07.2009	BREMBO	4	44	32/Ø330		X284243	X284244
E 220 T CDI		03.2003	07.2009	BOSCH	1	60	28		X274067	X274068
		03.2003	07.2009	BREMBO	4	44	32/Ø330		X284243	X284244
E 220 T CDI (211.206)		03.2003	07.2006	BOSCH	1	60	28		X274067	X274068
		03.2003	07.2006	BREMBO	4	44	32/Ø330		X284243	X284244
E 220 T CDI (211.208)		04.2006	07.2009	BOSCH	1	60	28		X274067	X274068
		04.2006	07.2009	BREMBO	4	44	32/Ø330		X284243	X284244
E 230 T (211.252)		05.2007	07.2009	BREMBO	4	44	28/Ø312		X284197	X284198
		05.2007	07.2009	BREMBO	4	44	32/Ø330		X284243	X284244
E 240 T (211.261)		03.2003	07.2009	BOSCH	1	60	28		X274067	X274068
E 270 T CDI (211.216)		03.2003	07.2005	BOSCH	1	60	28		X274067	X274068
		03.2003	07.2005	BREMBO	4	^{40/44}	28/Ø312		X284195	X284196
		03.2003	07.2005	BREMBO	4	^{40/44}	32/Ø330		X284157	X284158
E 280 T (211.254)		03.2005	07.2009	BREMBO	4	^{40/44}	28/Ø312		X284195	X284196
		03.2005	07.2009	BREMBO	4	44	28/Ø312		X284197	X284198
		03.2005	07.2009	BREMBO	4	44	32/Ø330		X284243	X284244
E 280 T 4-matic (211.292)		03.2005	07.2009	ATE	2	44	32		X224775	X224776
		03.2005	07.2009	BREMBO	4	44	28/Ø312		X284197	X284198
E 280 T CDI (211.220)		03.2005	07.2009	BOSCH	1	60	28		X274067	X274068
		03.2005	07.2009	BREMBO	4	^{40/44}	28/Ø312		X284195	X284196
		03.2005	07.2009	BREMBO	4	^{40/44}	32/Ø330		X284157	X284158
		03.2005	07.2009	BREMBO	4	44	32/Ø330		X284243	X284244
E 280 T CDI (211.223)		05.2004	07.2005	BREMBO	4	^{40/44}	28/Ø312		X284195	X284196

X=1 : SNRA - X=2 : EAI - X=3 : SERA - X=4 : SEEAC - X=5 : NEOTO - X=6 : STARTCAR

Affectations par Marques

Vehicule application - Zuordnung nach Marke und Fahrzeuge - Applicazione per marca e veicolo - Aplicacion por marca y vehiculo



MERCEDES-BENZ

CLASSE E T-Model (S211)

E 280 T CDI 4-matic (211.284)		03.2005		ATE	2	44	32		X224679	X224680
		03.2005	07.2009	ATE	2	44	32		X224775	X224776
E 320 T (211.265)		03.2003	07.2004	BREMBO	4	40/44	28/Ø312		X284195	X284196
E 320 T CDI (211.222)		03.2005	07.2009	BREMBO	4	40/44	28/Ø312		X284195	X284196
		03.2005	07.2009	BREMBO	4	44	32/Ø330		X284243	X284244
E 320 T CDI (211.226)		03.2003	07.2006	BREMBO	4	40/44	28/Ø312		X284195	X284196
E 320 T CDI 4-matic (211.289)		03.2005	07.2009	ATE	2	44	32		X224679	X224680
		03.2005	07.2009	ATE	2	44	32		X224775	X224776
E 350 T (211.256)		03.2005	07.2009	BREMBO	4	40/44	28/Ø312		X284195	X284196
		03.2005	07.2009	BREMBO	4	44	32/Ø330		X284243	X284244
E 350 T 4-matic (211.287)		03.2005	07.2006	ATE	2	44	32		X224679	X224680
		03.2005	07.2006	ATE	2	44	32		X224775	X224776
E 500 T (211.270)		10.2003	07.2009	BREMBO	4	40/44	32/Ø330		X284157	X284158
E 500 T (211.272)		04.2006	07.2009	BREMBO	4	44	32		X284109	X284110
		04.2006	07.2009	BREMBO	4	44	32/Ø330		X284243	X284244
E 500 T 4-matic (211.283)		10.2003	07.2009	ATE	2	44	32		X224679	X224680
		10.2003	07.2009	ATE	2	44	32		X224775	X224776
		10.2003	10.2004	ATE	2	44	32		X224885	X224886
E 500 T 4-matic (211.290)		04.2006	07.2009	ATE	2	44	32		X224679	X224680
		04.2006	07.2009	ATE	2	44	32		X224775	X224776
Tout / All / Alle / Tutti / Todos		03.2003	07.2009	ATE	1	42	11		X225331	X225332
		03.2003	07.2009	ATE	1	42	22		X225311	X225312

CLASSE E T-Model (S212)

E 200 (212.234)		11.2012		GIRL-TRW	1	60	28/Ø295		X374771	X374772
E 200 CDI / BlueTEC (212.205, 212.206)		11.2009		GIRL-TRW	1	60	28/Ø295		X374771	X374772
E 200 CGI (212.248)		11.2009		GIRL-TRW	1	60	28/Ø295		X374771	X374772
E 220 CDI (212.202)		07.2009		GIRL-TRW	1	60	28/Ø295		X374771	X374772
E 220 CDI / BlueTEC (212.202, 212.201)		11.2009		GIRL-TRW	1	60	28/Ø295		X374771	X374772
E 250 (212.236)		11.2012		GIRL-TRW	1	60	32/Ø322		X374769	X374770
E 250 CDI / BlueTEC (212.203, 212.204)		11.2009		GIRL-TRW	1	60	32/Ø322		X374769	X374770
E 250 CGI (212.247)		11.2009		GIRL-TRW	1	60	32/Ø322		X374769	X374770
E 300 (212.255)		07.2011		GIRL-TRW	1	60	32/Ø322		X374769	X374770
E 300 CDI (212.220)		03.2011		GIRL-TRW	1	60	32/Ø322		X374769	X374770
E 300 CDI / BlueTEC (212.227)		11.2009		GIRL-TRW	1	60	32/Ø322		X374769	X374770
E 300 Hybrid / BlueTEC Hybrid (212.298)		12.2011		GIRL-TRW	1	60	32/Ø322		X374769	X374770
E 350 (212.256)		08.2009	12.2011	GIRL-TRW	1	60	32/Ø322		X374769	X374770
E 350 (212.259)		09.2011		GIRL-TRW	1	60	32/Ø322		X374769	X374770
E 350 BlueTEC		11.2012		BREMBO	4	44	32		X284239	X284240
		11.2012		GIRL-TRW	1	60	32/Ø322		X374769	X374770
E 350 BlueTEC (212.224)		11.2009	12.2012	GIRL-TRW	1	60	32/Ø322		X374769	X374770
E 350 CDI (212.223)		07.2011		GIRL-TRW	1	60	32/Ø322		X374769	X374770
E 350 CDI (212.225)		11.2009		GIRL-TRW	1	60	32/Ø322		X374769	X374770

X=1 : SNRA - X=2 : EAI - X=3 : SERA - X=4 : SEEC - X=5 : NEOTO - X=6 : STARTCAR

Affectations par Marques

Vehicule application - Zuordnung nach Marke und Fahrzeuge - Applicazione per marca e veicolo - Aplicacion por marca y vehiculo



MERCEDES-BENZ

CLASSE E T-Model (S212)

E 350 CGI (212.257)		11.2009		GIRL-TRW	1	60	32/Ø322		X374769	X374770
E 400		01.2013		BREMBO	4	44	32		X284239	X284240
E 500 (212.272)		11.2009		BREMBO	4	44	32		X284239	X284240
Tout / All / Alle / Tutti / Todos		08.2009		ATE	1	42	22		X225437	X225438

CLASSE G (W463)

G 65 AMG		05.2012		ATE	2	44	32		X224679	X224680
		05.2012		ATE	2	44	32		X224775	X224776
Tout / All / Alle / Tutti / Todos		05.2012		ATE	1	42	22		X225351	X225352

CLASSE GL (X164)

Tout / All / Alle / Tutti / Todos		09.2006		ATE	2	44	32		X224775	X224776
		09.2006		ATE	1	42	22		X225351	X225352

CLASSE GLA (X156)

GLA 200 (156.943)		12.2013		GIRL-TRW	1	60	28	V. SPORT	X374753	X374754
		12.2013		GIRL-TRW	1	60	28/Ø295		X374751	X374752
GLA 200 CDI (156.908)		12.2013		GIRL-TRW	1	60	28	V. SPORT	X374753	X374754
		12.2013		GIRL-TRW	1	60	28/Ø295		X374751	X374752
GLA 200 CDI 4-matic (156.902)		12.2013		GIRL-TRW	1	60	28	V. SPORT	X374753	X374754
		12.2013		GIRL-TRW	1	60	28/Ø295		X374751	X374752
GLA 220 CDI 4-matic (156.905)		12.2013		GIRL-TRW	1	60	28/Ø295		X374751	X374752
Tout / All / Alle / Tutti / Todos		12.2013		GIRL-TRW	1	34	9/Ø276		X377059	X377060

CLASSE GLK (X204)

Tout / All / Alle / Tutti / Todos		06.2008		BOSCH	2	44	32		X274131	X274132
		06.2008		ATE	1	42	22		X225439	X225440

CLASSE M (W163)

ML 230 (163.136)		02.1998	08.2000	ATE	1	60	26		X224891	X224892
		02.1998	08.2000	K/H	1	60	26		X404015	X404016
		02.1998	08.2000	K/H	1	44	15		X405003	X405004
ML 270 CDI (163.113)		12.1999	06.2005	ATE	1	60	26		X224891	X224892
		12.1999	06.2005	K/H	1	60	26		X404015	X404016
		12.1999	06.2005	K/H	1	44	15		X405003	X405004
ML 320 (163.154)		02.1998	08.2002	ATE	1	60	26		X224891	X224892
		02.1998	08.2002	K/H	1	60	26		X404015	X404016
		02.1998	08.2002	K/H	1	44	15		X405003	X405004
ML 350		02.2003	06.2005	BREMBO	4	40/44	32		X284083	X284084
		02.2003	06.2005	BREMBO	2	40	14		X285041	X285042
ML 350 (163.157)		08.2002	07.2003	BREMBO	4	40/44	32		X284083	X284084
		08.2002	07.2003	BREMBO	2	40	14		X285041	X285042
ML 400 CDI (163.128)		09.2001	06.2005	BREMBO	4	40/44	32		X284083	X284084
		09.2001	06.2005	BREMBO	2	40	14		X285041	X285042
ML 430 (163.172)		02.1998	06.2005	BREMBO	4	40/44	32		X284083	X284084
		02.1998	06.2005	BREMBO	2	40	14		X285041	X285042

X=1 : SNRA - X=2 : EAI - X=3 : SERA - X=4 : SEEAC - X=5 : NEOTO - X=6 : STARTCAR

Affectations par Marques

Vehicule application - Zuordnung nach Marke und Fahrzeuge - Applicazione per marca e veicolo - Aplicacion por marca y vehiculo



MERCEDES-BENZ

CLASSE M (W163)

ML 500 (163.175)		09.2001	06.2005	BREMBO	4	40/44	32		X284083	X284084
		09.2001	06.2005	BREMBO	2	40	14		X285041	X285042
ML 55 AMG (163.174)		02.2000	06.2005	BREMBO	4	40/44	32		X284083	X284084
		02.2000	06.2005	BREMBO	4	40/44	32		X284201	X284202
		02.2000	06.2005	BREMBO	2	40	14		X285041	X285042

CLASSE M (W164)

ML 280 CDI 4-matic (164.120)		07.2005	07.2009	ATE	1	40	14		X225347	X225348
ML 300 CDI 4-matic (164.120)		07.2009	12.2011	ATE	1	40	14		X225347	X225348
ML 300 CDI 4-matic (164.121)		02.2010	12.2011	ATE	1	40	14		X225347	X225348
		02.2010	12.2011	ATE	1	42	22		X225351	X225352
ML 320 CDI 4-matic (164.122)		07.2005	07.2009	ATE	1	40	14		X225347	X225348
		07.2005	07.2009	ATE	1	42	22		X225351	X225352
ML 350 4-matic (164.186)		07.2005	06.2012	ATE	1	40	14		X225347	X225348
		07.2005	06.2012	ATE	1	42	22		X225351	X225352
ML 350 CDI 4-matic		09.2009	06.2012	ATE	1	40	14		X225347	X225348
ML 350 CDI 4-matic (164.122)		07.2009	06.2012	ATE	1	40	14		X225347	X225348
		07.2009	06.2012	ATE	1	42	22		X225351	X225352
ML 350 CDI 4-matic (164.125)		02.2010	12.2011	ATE	1	40	14		X225347	X225348
		02.2010	12.2011	ATE	1	42	22		X225351	X225352
ML 420 CDI 4-matic (164.128)		02.2006	09.2009	ATE	1	42	22		X225351	X225352
ML 450 CDI 4-matic (164.128)		09.2009	12.2011	ATE	1	42	22		X225351	X225352
ML 500 4-matic (164.172)		12.2007	06.2012	ATE	1	42	22		X225351	X225352
ML 500 4-matic (164.175)		07.2005	12.2007	ATE	1	42	22		X225351	X225352
Tout / All / Alle / Tutti / Todos		07.2005		ATE	2	44	32		X224775	X224776

CLASSE M (W166)

ML 250 CDI BlueTEC 4-matic (166.003/.00)		06.2011		ATE	1	60	26		X224891	X224892
		06.2011		K/H	1	60	26		X404015	X404016
		06.2011		GIRL-TRW	1	44	14/Ø325		X377073	X377074
		06.2011		K/H	1	44	15		X405003	X405004
ML 350 4-matic (166.057)		06.2011	02.2015	GIRL-TRW	1	44	14/Ø325		X377073	X377074
ML 350 BlueTEC 4-matic (166.024)		06.2011	02.2015	GIRL-TRW	1	44	14/Ø325		X377073	X377074

CLASSE R (W251, V251)

Tout / All / Alle / Tutti / Todos		01.2006	12.2014	ATE	2	44	32		X224775	X224776
		01.2006	12.2014	ATE	1	40	14		X225347	X225348
		01.2006	12.2014	ATE	1	42	22		X225351	X225352

CLASSE S (C126)

380 SEC (126.043)		10.1981	07.1985	GIRL-TRW	1	60	22		X374171	X374172
420 SEC (126.046)		10.1985	09.1986	ATE	2	57	28		X224183	X224184
		10.1985	06.1991	BENDIX	2	57	28		X254111	X254112
		10.1985	09.1986	ATE	2	38	10/Ø269		X225035	X225036

X=1 : SNRA - X=2 : EAI - X=3 : SERA - X=4 : SEEAC - X=5 : NEOTO - X=6 : STARTCAR

Affectations par Marques

Vehicule application - Zuordnung nach Marke und Fahrzeuge - Applicazione per marca e veicolo - Aplicacion por marca y vehiculo



MERCEDES-BENZ

CLASSE S (C126)

500 SEC (126.044)		09.1985	06.1991	ATE	2	57	28		X224183	X224184
		09.1985	06.1991	BENDIX	2	57	28		X254111	X254112
		09.1985	06.1991	ATE	2	38	10/Ø279		X225049	X225050
500 SEC CAT		06.1989	06.1991	ATE	2	57	28		X224183	X224184
		06.1989	06.1991	BENDIX	2	57	28		X254111	X254112
		06.1989	06.1991	ATE	2	38	10/Ø279		X225049	X225050
560 SEC (126.045)		10.1985	06.1991	ATE	2	57	28		X224183	X224184
		10.1985	06.1991	BENDIX	2	57	28		X254111	X254112
		10.1985	06.1991	ATE	2	38	10/Ø279		X225049	X225050
		10.1985	06.1991	BENDIX	2	38	10		X255021	X255022

CLASSE S (C140)

SEC/CL 420 (140.063)		10.1994	08.1998	ATE	2	57	28		X224251	X224252
		10.1994	08.1998	GIRL-TRW	4	40/44	28		X374259	X374260
		10.1994	08.1998	ATE	2	46	22		X225251	X225252
		10.1994	08.1998	BENDIX	2	46	22		X255023	X255024
SEC/CL 500 (140.070)		10.1992	02.1999	ATE	2	57	28		X224251	X224252
		10.1992	02.1999	GIRL-TRW	4	40/44	28		X374259	X374260
		10.1992	02.1999	ATE	2	46	22		X225251	X225252
		10.1992	02.1999	BENDIX	2	46	22		X255023	X255024
SEC/CL 600 (140.076)		09.1992	02.1999	ATE	2	57	28		X224251	X224252
		09.1992	02.1999	GIRL-TRW	4	40/44	28		X374259	X374260
		09.1992	02.1999	ATE	2	46	22		X225251	X225252
		09.1992	02.1999	BENDIX	2	46	22		X255023	X255024

CLASSE S (C215)

CL 500 (215.375)		03.1999	12.2001	BREMBO	4	40/44	32		->024509	X284205	X284206
		01.2002	03.2006	BREMBO	4	40/44	32/Ø330		024510->	X284157	X284158
		03.1999	03.2006	ATE	1	42	22			X225449	X225450
		03.1999	03.2006	ATE	2	42	22			X225431	X225432

CLASSE S (C216)

CL 500 (216.371)		06.2006	12.2013	BREMBO	4	44	32			X284109	X284110
CL 500 (216.373)		02.2008	12.2013	ATE	1	42	24			X225312	X225311
CL 500 4-matic (216.386)		02.2008	12.2013	BREMBO	4	44	32			X284225	X284226
		02.2008	12.2013	ATE	1	42	24			X225312	X225311
CL 500 4-matic (216.394)		02.2008	12.2013	BREMBO	4	44	32			X284225	X284226
		02.2008	12.2013	ATE	1	42	24			X225312	X225311

CLASSE S (W108, W109)

Tout / All / Alle / Tutti / Todos		01.1966	08.1972	ATE	2	57	12,7			X224057	X224058
		01.1966	08.1972	ATE	2	57	19			X224317	X224318
		01.1966	08.1972	BENDIX	2	57	12,7			X254029	X254030
		01.1966	08.1972	ATE	2	35	10			X225027	X225028
		01.1966	08.1972	ATE	2	42	10			X225019	X225020
		01.1966	08.1972	ATE	2	42	10			X225139	X225140

X=1 : SNRA - X=2 : EAI - X=3 : SERA - X=4 : SEEAC - X=5 : NEOTO - X=6 : STARTCAR

Affectations par Marques

Vehicule application - Zuordnung nach Marke und Fahrzeuge - Applicazione per marca e veicolo - Aplicacion por marca y vehiculo



MERCEDES-BENZ

CLASSE S (W116)

Tout / All / Alle / Tutti / Todos		08.1972	07.1980	ATE	2	60	22		X224143	X224144
		08.1972	07.1980	BENDIX	2	60	22		X254027	X254028
		01.1973	07.1980	ATE	2	38	10		X225035	X225036
		01.1973	07.1980	ATE	2	38	10		X225049	X225050
		01.1973	07.1980	BENDIX	2	38	10		X255005	X255006
		01.1973	07.1980	GIRL-TRW	2	38	10		X375007	X375008

CLASSE S (W126)

260 S (126.020)		01.1980	08.1985	ATE	2	60	22		X224153	X224154
		06.1981	08.1985	GIRL-TRW	1	60	22		X374171	X374172
		09.1985	06.1991	ATE	2	57	28		X224183	X224184
		09.1985	06.1991	BENDIX	2	57	28		X254111	X254112
		01.1980	06.1991	ATE	2	38	10		X225035	X225036
		01.1980	06.1991	BENDIX	2	38	10		X255005	X255006
280 S (126.021)		12.1979	07.1985	ATE	2	60	22		X224153	X224154
		12.1979	07.1985	BENDIX	2	60	22		X254077	X254078
		12.1979	07.1985	ATE	2	38	10		X225035	X225036
		12.1979	07.1985	BENDIX	2	38	10		X255005	X255006
		12.1979	07.1985	GIRL-TRW	2	38	10		X375007	X375008
280 SE,SEL (126.022, 126.023)		10.1979	07.1985	ATE	2	60	22		X224153	X224154
		10.1979	07.1985	BENDIX	2	60	22		X254077	X254078
		10.1979	07.1985	ATE	2	38	10		X225035	X225036
		10.1979	07.1985	BENDIX	2	38	10		X255005	X255006
		10.1979	07.1985	GIRL-TRW	2	38	10		X375007	X375008
300 SE,SEL (126.024, 126.025)		09.1985	12.1989	ATE	2	57	28		X224183	X224184
		09.1985	12.1989	BENDIX	2	57	28		X254111	X254112
		09.1985	12.1989	ATE	2	38	10		X225035	X225036
		09.1985	12.1989	BENDIX	2	38	10		X255005	X255006
		09.1985	12.1989	GIRL-TRW	2	38	10		X375007	X375008
380 SE,SEL (126.032)		01.1981	12.1986	ATE	2	60	22		X224153	X224154
		01.1981	12.1986	BENDIX	2	60	22		X254077	X254078
		09.1985	03.1991	GIRL-TRW	1	60	22		X374171	X374172
		01.1981	03.1991	ATE	2	38	10		X225035	X225036
		01.1981	03.1991	BENDIX	2	38	10		X255005	X255006
		01.1981	03.1991	GIRL-TRW	2	38	10		X375007	X375008
420 SE,SEL		01.1980	08.1985	BENDIX	2	60	22		X254077	X254078
		06.1981	08.1985	GIRL-TRW	1	60	22		X374171	X374172
		10.1985	06.1991	ATE	2	57	28		X224183	X224184
		10.1985	06.1991	BENDIX	2	57	28		X254111	X254112
		01.1980	06.1991	ATE	2	38	10		X225035	X225036
		01.1980	06.1991	BENDIX	2	38	10		X255005	X255006
		01.1980	06.1991	BENDIX	2	38	10		X255019	X255020
		01.1980	06.1991	BENDIX	2	38	10		X255021	X255022
		01.1980	06.1991	GIRL-TRW	2	38	10		X375007	X375008

X=1 : SNRA - X=2 : EAI - X=3 : SERA - X=4 : SEEAC - X=5 : NEOTO - X=6 : STARTCAR

Affectations par Marques

Vehicule application - Zuordnung nach Marke und Fahrzeuge - Applicazione per marca e veicolo - Aplicacion por marca y vehiculo



MERCEDES-BENZ

CLASSE S (W126)

500 SE, SEL, SE CAT		09.1978	08.1985	ATE	2	60	22		X224153	X224154
		01.1980	08.1985	BENDIX	2	60	22		X254077	X254078
		06.1981	08.1985	GIRL-TRW	1	60	22		X374171	X374172
		09.1985	03.1991	ATE	2	57	28		X224183	X224184
		09.1985	03.1991	BENDIX	2	57	28		X254111	X254112
		09.1978	03.1991	ATE	2	38	10		X225049	X225050
		09.1978	03.1991	BENDIX	2	38	10		X255021	X255022
560 SE,SEL		01.1980	08.1985	ATE	2	60	22		X224153	X224154
		09.1985	12.1991	ATE	4	40			X224583	X224584
		08.1987	06.1991	ATE	2	57	28		X224183	X224184
		08.1987	06.1991	BENDIX	2	57	28		X254111	X254112
		09.1985	12.1991	ATE	2	38	10		X225049	X225050
		09.1985	12.1991	BENDIX	2	38	10		X255019	X255020
		09.1985	12.1991	BENDIX	2	38	10		X255021	X255022

CLASSE S (W140)

300 SE 2.8 (140.028)		01.1993	10.1998	ATE	2	57	28		X224251	X224252
		01.1993	10.1998	GIRL-TRW	4	40/44	28		X374259	X374260
		01.1993	10.1998	ATE	2	40	12		X225091	X225092
300 SE,SEL/S320 (140.032, 140.033)		03.1991	10.1998	ATE	2	57	28		X224251	X224252
		03.1991	10.1998	GIRL-TRW	4	40/44	28		X374259	X374260
		03.1991	10.1998	ATE	2	40	12		X225091	X225092
400 SE,SEL/S420 (140.042, 140.043)		02.1991	10.1998	ATE	2	57	28		X224251	X224252
		02.1991	10.1998	GIRL-TRW	4	40/44	28		X374259	X374260
		02.1991	10.1998	ATE	2	46	22		X225251	X225252
		02.1991	10.1998	BENDIX	2	46	22		X255023	X255024
500 SE,SEL (140.050, 140.051)		02.1991	10.1998	ATE	2	57	28		X224251	X224252
		02.1991	10.1998	GIRL-TRW	4	40/44	28		X374259	X374260
		02.1991	10.1998	ATE	2	46	22		X225251	X225252
		02.1991	10.1998	BENDIX	2	46	22		X255023	X255024
600 SE,SEL (140.056, 140.057)		04.1991	12.1992	ATE	2	57	28		X224251	X224252
		04.1991	12.1992	GIRL-TRW	4	40/44	28		X374259	X374260
		04.1991	12.1992	ATE	2	46	22		X225251	X225252
		04.1991	12.1992	BENDIX	2	46	22		X255023	X255024
S 280 (140.028)		02.1993	10.1998	ATE	2	57	28		X224251	X224252
		02.1993	10.1998	GIRL-TRW	4	40/44	28		X374259	X374260
		02.1993	10.1998	ATE	2	40	12		X225091	X225092
S 300 Turbo-D (140.135)		05.1996	10.1998	ATE	2	57	28		X224251	X224252
		05.1996	10.1998	GIRL-TRW	4	40/44	28		X374259	X374260
		05.1996	10.1998	ATE	2	40	12		X225091	X225092
S 320		01.1993	10.1998	ATE	2	57	28		X224251	X224252
		01.1993	10.1998	GIRL-TRW	4	40/44	28		X374259	X374260
		01.1993	10.1998	ATE	2	40	12		X225091	X225092

Affectations par Marques

Vehicule application - Zuordnung nach Marke und Fahrzeuge - Applicazione per marca e veicolo - Aplicacion por marca y vehiculo



MERCEDES-BENZ

CLASSE S (W140)

S 350 Turbo-D (140.134)		01.1993	10.1998	ATE	2	57	28		X224251	X224252
		01.1993	10.1998	GIRL-TRW	4	40/44	28		X374259	X374260
		01.1993	10.1998	ATE	2	40	12		X225091	X225092
S 420 (140.042)		01.1993	10.1998	ATE	2	57	28		X224251	X224252
		01.1993	10.1998	GIRL-TRW	4	40/44	28		X374259	X374260
		01.1993	10.1998	ATE	2	46	22		X225251	X225252
		01.1993	10.1998	BENDIX	2	46	22		X255023	X255024
S 500 (140.050, 140.051)		01.1993	10.1998	ATE	2	57	28		X224251	X224252
		01.1993	10.1998	GIRL-TRW	4	40/44	28		X374259	X374260
		01.1993	10.1998	ATE	2	40	12		X225091	X225092
		01.1993	10.1998	ATE	2	46	22		X225251	X225252
		01.1993	10.1998	BENDIX	2	46	22		X255023	X255024
S 600 (140.056, 140.057)		01.1993	09.1995	ATE	2	57	28		X224251	X224252
		01.1993	09.1995	GIRL-TRW	4	40/44	28		X374259	X374260
		01.1993	10.1998	ATE	2	40	12		X225091	X225092
		01.1993	10.1998	ATE	2	46	22		X225251	X225252
		01.1993	10.1998	BENDIX	2	46	22		X255023	X255024

CLASSE S (W220)

S 280 (220.063, 220.163)		10.1998	08.2005	BREMBO	4	40/44	28		X284203	X284204
		10.1998	08.2005	BREMBO	4	40/44	28/Ø312		X284195	X284196
		10.1998	08.2005	ATE	1	42	11		X225391	X225392
		10.1998	08.2005	ATE	2	42	11		X225395	X225396
S 320 (220.065, 220.165)		10.1998	08.2005	BREMBO	4	40/44	28		X284203	X284204
		10.1998	08.2005	BREMBO	4	40/44	28/Ø312		X284195	X284196
		10.1998	08.2005	ATE	2	42	11		X225395	X225396
S 320 CDI (220.025, 220.125)		09.2002	08.2005	BREMBO	4	40/44	32/Ø330		X284157	X284158
		09.2002	08.2005	ATE	1	42	11		X225391	X225392
S 320 CDI (220.026, 220.126)		08.1999	12.2001	BREMBO	4	40/44	32		X284205	X284206
		08.1999	09.2002	BREMBO	4	40/44	32/Ø330		X284157	X284158
		08.1999	09.2002	ATE	2	42	11		X225395	X225396
S 350 (220.067, 220.167)		09.2002	08.2005	BREMBO	4	40/44	28/Ø312		X284195	X284196
		09.2002	08.2005	ATE	1	42	11		X225391	X225392
S 350 4-matic (220.087, 220.187)		06.2003	08.2005	ATE	1	42	22		X225449	X225450
S 400 CDI (220.028, 220.128)		06.2000	12.2001	BREMBO	4	40/44	32		X284205	X284206
		06.2000	08.2005	BREMBO	4	40/44	32/Ø330		X284157	X284158
		06.2000	08.2005	ATE	1	42	22		X225449	X225450
		06.2000	09.2002	ATE	2	42	22		X225431	X225432
S 430 (220.070, 220.170)		10.1998	12.2001	BREMBO	4	40/44	32		X284205	X284206
		10.1998	08.2005	BREMBO	4	40/44	32/Ø330		X284157	X284158
		10.1998	08.2005	ATE	1	42	22		X225449	X225450
		10.1998	09.2002	ATE	2	42	22		X225431	X225432

X=1 : SNRA - X=2 : EAI - X=3 : SERA - X=4 : SEEAC - X=5 : NEOTO - X=6 : STARTCAR

Affectations par Marques

Vehicule application - Zuordnung nach Marke und Fahrzeuge - Applicazione per marca e veicolo - Aplicacion por marca y vehiculo



MERCEDES-BENZ

CLASSE S (W220)

S 430 4-matic (220.083, 220.183)		09.2002	08.2005	ATE	2	44	32		X224885	X224886
		09.2002	08.2005	ATE	2	44	32/Ø330		X224897	X224898
		09.2002	08.2005	ATE	1	42	22		X225449	X225450
S 500 (220.075, 220.175, 220.875)		10.1998	12.2001	BREMBO	4	40/44	32		X284205	X284206
		10.1998	08.2005	BREMBO	4	40/44	32/Ø330		X284157	X284158
		10.1998	08.2005	ATE	1	42	22		X225449	X225450
		10.1998	09.2002	ATE	2	42	22		X225431	X225432
		10.1998	08.2005	ATE	2	46	22		X225251	X225252
		10.1998	08.2005	BENDIX	2	46	22		X255023	X255024
S 500 4-matic (220.084, 220.184)		09.2002	08.2005	ATE	2	44	32		X224885	X224886
		09.2002	08.2005	ATE	2	44	32/Ø330		X224897	X224898
		09.2002	08.2005	ATE	1	42	22		X225449	X225450
S 600 (220.878, 220.178)		01.2000	08.2002	ATE	2	46	22		X225251	X225252
		01.2000	08.2002	BENDIX	2	46	22		X255023	X255024

CLASSE S (W221)

S 250 CDI (221.003, 221.103)		01.2011	07.2013	BREMBO	4	44	32		X284225	X284226
S 280 (221.054)		08.2006	07.2013	BREMBO	4	44	32		X284141	X284142
S 300 (221.054)		08.2006	07.2013	BREMBO	4	44	32		X284141	X284142
S 320 CDI		10.2005	12.2012	BREMBO	4	44	32		X284141	X284142
S 320 CDI (221.022, 221.122)		12.2005	06.2009	BREMBO	4	44	32		X284141	X284142
S 320 CDI 4-matic (221.080, 221.180)		10.2005	12.2012	BREMBO	4	44	32		X284225	X284226
S 350 (221.056, 221.156)		10.2005	07.2013	BREMBO	4	44	32		X284141	X284142
S 350 4-matic (221.087, 221.187)		02.2008	07.2013	BREMBO	4	44	32		X284141	X284142
		02.2008	07.2013	BREMBO	4	44	32		X284223	X284224
S 350 BlueTec (221.026, 221.126)		04.2011	07.2013	BREMBO	4	44	32		X284225	X284226
S 350 BlueTEC 4-matic (221.083, 221.183)		04.2011	07.2013	BREMBO	4	44	32		X284225	X284226
S 350 CDI		06.2009	07.2013	BREMBO	4	44	32		X284141	X284142
S 350 CGI (221.057, 221.157)		04.2011	07.2013	BREMBO	4	44	32		X284141	X284142
S 350 CGI 4-matic (221.082, 221.182)		04.2011	07.2013	BREMBO	4	44	32		X284141	X284142
		04.2011	07.2013	BREMBO	4	44	32		X284223	X284224
S 400 Hybrid (221.095, 221.195)		01.2009		BREMBO	4	44	32		X284225	X284226
S 420 CDI / S 450 CDI (221.028, 221.128)		10.2006	12.2012	BREMBO	4	44	32		X284109	X284110
S 450 (221.070, 221.170)		12.2005	07.2013	BREMBO	4	44	32		X284109	X284110
S 450 4-matic (221.084, 221.184)		12.2005	07.2013	BREMBO	4	44	32		X284225	X284226
S 500 (221.071, 221.171)		10.2005	07.2013	BREMBO	4	44	32		X284109	X284110
S 500 4-matic (221.086, 221.186)		10.2005		BREMBO	4	44	32		X284225	X284226
Tout / All / Alle / Tutti / Todos		08.2006		ATE	1	42	22		X225311	X225312

CLASSE V (638/2)

Tout / All / Alle / Tutti / Todos		09.1996	07.2003	BENDIX	1	60	22		X254231	X254232
V 200 (638.214, 638.294)		02.1997	07.2003	ATE	1	33	10		X225183	X225184
		02.1997	07.2003	BOSCH	1	33	10		X275021	X275022
V 200 CDI (638.294)		03.1999	07.2003	BOSCH	1	33	10		X275021	X275022

X=1 : SNRA - X=2 : EAI - X=3 : SERA - X=4 : SEEC - X=5 : NEOTO - X=6 : STARTCAR

Affectations par Marques

Vehicule application - Zuordnung nach Marke und Fahrzeuge - Applicazione per marca e veicolo - Aplicacion por marca y vehiculo



MERCEDES-BENZ

CLASSE V (638/2)

V 220 CDI (638.294)		03.1999	07.2003	BOSCH	1	33	10		X275021	X275022
V 230 (638.234, 638.294)		10.1996	03.1999	ATE	1	33	10		X225183	X225184
		10.1996	03.1999	BOSCH	1	33	10		X275021	X275022
V 230 TD (638.274)		09.1996	02.1999	ATE	1	33	10		X225183	X225184
		09.1996	02.1999	BOSCH	1	33	10		X275021	X275022
V 280 (638.244, 638.294)		08.1997	07.2003	ATE	1	33	10		X225183	X225184
		08.1997	07.2003	BOSCH	1	33	10		X275021	X275022

CLK (A208)

200 (208.435)		03.1998	03.2002	ATE	1	57	25/Ø288		X224437	X224438
		03.1998	03.2002	ATE	2	36	9	1 axe pour plaquettes	X225223	X225224
		03.1998	03.2002	ATE	2	38	9/Ø278	2 axe pour plaquettes	X225191	X225192
200 Kompressor (208.444)		06.2000	03.2002	ATE	1	57	28/Ø300		X224439	X224440
		06.2000	03.2002	ATE	2	36	10		X225221	X225222
		06.2000	03.2002	ATE	2	36	10/Ø290	1 axe pour plaquettes	X225313	X225314
200 Kompressor (208.445)		03.1998	06.2000	ATE	1	57	28/Ø300		X224439	X224440
		03.1998	06.2000	ATE	2	36	10		X225221	X225222
230 Kompressor (208.447)		03.1998	06.2000	ATE	1	57	28/Ø300		X224439	X224440
		03.1998	06.2000	ATE	2	36	10		X225221	X225222
230 Kompressor (208.448)		06.2000	03.2002	ATE	1	57	28/Ø300		X224439	X224440
		06.2000	03.2002	ATE	2	36	10		X225221	X225222
		06.2000	03.2002	ATE	2	36	10/Ø290	1 axe pour plaquettes	X225313	X225314
320 (208.465)		03.1998	03.2002	ATE	1	57	28/Ø300		X224439	X224440
		03.1998	03.2002	ATE	2	36	10		X225221	X225222
		03.1998	03.2002	ATE	2	36	10/Ø290	1 axe pour plaquettes	X225313	X225314
430 (208.470)		09.1998	03.2002	ATE	2	44	32		X224885	X224886
		09.1998	03.2002	ATE	4	^{38/42}	28		X224667	X224668
		09.1998	03.2002	ATE	2	42	20/Ø300		X225165	X225166
55 AMG (208.474, 208.374)		01.2000	03.2002	ATE	2	42	20/Ø300		X225165	X225166

CLK (A209)

CLK 200 Kompressor (209.441)		10.2006	03.2010	BREMBO	2	57	28/Ø330		X284121	X284122
		10.2006	03.2010	GIRL-TRW	1	57	28/Ø300		X374605	X374606
CLK 200 Kompressor (209.442)		02.2003	03.2010	BREMBO	2	57	28/Ø330		X284121	X284122
		02.2003	03.2010	GIRL-TRW	1	57	28/Ø300		X374605	X374606
CLK 240 (209.461)		02.2003	07.2005	GIRL-TRW	1	57	28/Ø300		X374605	X374606
CLK 280 (209.454)		01.2005	03.2010	BREMBO	2	57	28/Ø330		X284121	X284122
		01.2005	03.2010	GIRL-TRW	1	57	28/Ø300		X374605	X374606
CLK 320 (209.465)		02.2003	07.2005	GIRL-TRW	1	57	28/Ø300		X374605	X374606
CLK 320 CDI (209.420)		03.2005	03.2010	BREMBO	2	57	28/Ø330		X284121	X284122
		03.2005	03.2010	BREMBO	4	^{40/44}	30/Ø345		X284221	X284222
CLK 350 (209.456)		01.2005	03.2010	BREMBO	2	57	28/Ø330		X284121	X284122
		01.2005	03.2010	BREMBO	4	^{40/44}	30/Ø345		X284221	X284222
CLK 500 (209.472)		06.2006	03.2010	BREMBO	4	^{40/44}	30/Ø345		X284221	X284222

X=1 : SNRA - X=2 : EAI - X=3 : SERA - X=4 : SEEAC - X=5 : NEOTO - X=6 : STARTCAR

Affectations par Marques

Vehicule application - Zuordnung nach Marke und Fahrzeuge - Applicazione per marca e veicolo - Aplicacion por marca y vehiculo



MERCEDES-BENZ

CLK (A209)

CLK 500 (209.475)		02.2003	05.2006	BREMBO	4	40/44	30/Ø345		X284221	X284222
Tout / All / Alle / Tutti / Todos		02.2003		ATE	2	36	10/Ø290	1 axe pour plaquettes	X225313	X225314

CLK (C208)

200 (208.335)		06.1997	05.2000	ATE	1	57	25/Ø288		X224437	X224438
		06.1997	05.2000	ATE	2	36	9	1 axe pour plaquettes	X225223	X225224
		06.1997	05.2000	ATE	2	38	9/Ø278	2 axe pour plaquettes	X225191	X225192
200 Kompressor (208.344)		06.2000	06.2002	ATE	1	57	25/Ø288		X224437	X224438
		06.2000	06.2002	ATE	2	36	9	1 axe pour plaquettes	X225223	X225224
		06.2000	06.2002	ATE	2	38	9/Ø278	2 axe pour plaquettes	X225191	X225192
200 Kompressor (208.345)		06.1997	06.2000	ATE	1	57	25/Ø288		X224437	X224438
		06.1997	06.2000	ATE	2	36	9	1 axe pour plaquettes	X225223	X225224
		06.1997	06.2000	ATE	2	38	9/Ø278	2 axe pour plaquettes	X225191	X225192
230 Kompressor (208.347)		06.1997	06.2000	ATE	1	57	25/Ø288		X224437	X224438
		06.1997	06.2000	ATE	2	36	9	1 axe pour plaquettes	X225223	X225224
		06.1997	06.2000	ATE	2	38	9/Ø278	2 axe pour plaquettes	X225191	X225192
230 Kompressor (208.348)		06.2000	06.2002	ATE	1	57	25/Ø288		X224437	X224438
		06.2000	06.2002	ATE	2	36	9	1 axe pour plaquettes	X225223	X225224
		06.2000	06.2002	ATE	2	38	9/Ø278	2 axe pour plaquettes	X225191	X225192
320 (208.365)		06.1997	06.2002	ATE	1	57	28/Ø300		X224439	X224440
		06.1997	06.2002	ATE	2	36	10		X225221	X225222
		06.1997	06.2002	ATE	2	36	10/Ø290	1 axe pour plaquettes	X225313	X225314
430 (208.370)		07.1998	06.2002	ATE	2	44	32		X224885	X224886
		07.1998	06.2002	ATE	4	38/42	28		X224667	X224668
		07.1998	09.1999	ATE	2	36	10		X225221	X225222
		07.1998	06.2002	ATE	2	36	10/Ø290	1 axe pour plaquettes	X225313	X225314
		07.1998	06.2002	ATE	2	42	20/Ø300		X225165	X225166
55 AMG (208.374)		08.1999	06.2002	ATE	2	42	20/Ø300		X225165	X225166

CLK (C209)

200 CGI (209.343)		07.2003	07.2005	BREMBO	2	57	28/Ø330		X284121	X284122
		07.2003	07.2005	GIRL-TRW	1	57	25/Ø288		X374607	X374608
		07.2003	07.2005	ATE	2	36	10/Ø290	1 axe pour plaquettes	X225313	X225314
		07.2003	07.2005	ATE	2	36	9/Ø278	1 axe pour plaquettes	X225249	X225250
200 Kompressor (209.341)		10.2006	05.2009	BREMBO	2	57	28/Ø330		X284121	X284122
		10.2006	05.2009	GIRL-TRW	1	57	28/Ø300		X374605	X374606
		10.2006	05.2009	ATE	2	36	10/Ø290	1 axe pour plaquettes	X225313	X225314
200 Kompressor (209.342)		09.2002	05.2006	BREMBO	2	57	28/Ø330		X284121	X284122
		09.2002	05.2006	GIRL-TRW	1	57	25/Ø288		X374607	X374608
		09.2002	05.2006	ATE	2	36	10/Ø290	1 axe pour plaquettes	X225313	X225314
		09.2002	05.2006	ATE	2	36	9/Ø278	1 axe pour plaquettes	X225249	X225250
220 CDI (209.308)		01.2005	05.2009	BREMBO	2	57	28/Ø330		X284121	X284122
		01.2005	05.2009	GIRL-TRW	1	57	25/Ø288		X374607	X374608
		01.2005	05.2009	ATE	2	36	10/Ø290	1 axe pour plaquettes	X225313	X225314
		01.2005	05.2009	ATE	2	36	9/Ø278	1 axe pour plaquettes	X225249	X225250

X=1 : SNRA - X=2 : EAI - X=3 : SERA - X=4 : SEEC - X=5 : NEOTO - X=6 : STARTCAR

Affectations par Marques

Vehicule application - Zuordnung nach Marke und Fahrzeuge - Applicazione per marca e veicolo - Aplicacion por marca y vehiculo



MERCEDES-BENZ

CLK (C209)

240 (209.361)		06.2002	07.2005	GIRL-TRW	1	57	28/Ø300		X374605	X374606
		06.2002	07.2005	ATE	2	36	10/Ø290	1 axe pour plaquettes	X225313	X225314
270 CDI (209.316)		10.2002	07.2005	BREMBO	2	57	28/Ø330		X284121	X284122
		10.2002	07.2005	GIRL-TRW	1	57	28/Ø300		X374605	X374606
		10.2002	07.2005	ATE	2	36	10/Ø290	1 axe pour plaquettes	X225313	X225314
280 (209.354)		01.2005	05.2009	BREMBO	2	57	28/Ø330		X284121	X284122
		01.2005	05.2009	GIRL-TRW	1	57	28/Ø300		X374605	X374606
		01.2005	05.2009	ATE	2	36	10/Ø290	1 axe pour plaquettes	X225313	X225314
320 (209.365)		06.2002	07.2005	GIRL-TRW	1	57	28/Ø300		X374605	X374606
		06.2002	07.2005	ATE	2	36	10/Ø290	1 axe pour plaquettes	X225313	X225314
320 CDI (209.320)		01.2005	05.2009	BREMBO	2	57	28/Ø330		X284121	X284122
		01.2005	05.2009	BREMBO	4	40/44	30/Ø345		X284221	X284222
		01.2005	05.2009	ATE	2	36	10/Ø290	1 axe pour plaquettes	X225313	X225314
350 (209.356)		01.2005	05.2009	BREMBO	2	57	28/Ø330		X284121	X284122
		01.2005	05.2009	BREMBO	4	40/44	30/Ø345		X284221	X284222
		01.2005	05.2009	ATE	2	36	10/Ø290	1 axe pour plaquettes	X225313	X225314
500 (209.372)		06.2006	05.2009	BREMBO	4	40/44	30/Ø345		X284221	X284222
500 (209.375)		06.2002	05.2009	BREMBO	4	40/44	30/Ø345		X284221	X284222

CLS (C218)

Tout / All / Alle / Tutti / Todos		01.2011		BREMBO	4	44	32		X284239	X284240
		01.2011		ATE	1	42	22		X225437	X225438

CLS (C219)

CLS 320 CDI		01.2005	06.2006	BREMBO	4	40/44	28/Ø312		X284195	X284196
		01.2005	12.2010	BREMBO	4	44	28/Ø312		X284197	X284198
CLS 320 CDI (219.322)		01.2005	06.2006	BREMBO	4	40/44	28/Ø312		X284195	X284196
		01.2005	12.2010	BREMBO	4	44	28/Ø312		X284197	X284198
CLS 350 (219.356)		10.2004	06.2006	BREMBO	4	40/44	32/Ø330		X284157	X284158
CLS 350 (219.357)		04.2006		BREMBO	4	40/44	32/Ø330		X284157	X284158
CLS 350 CDI (219.322)		04.2009	12.2010	BREMBO	4	44	28/Ø312		X284197	X284198
CLS 500 (219.372)		04.2006	12.2010	BREMBO	4	44	32		X284109	X284110
CLS 500 (219.375)		10.2004	12.2010	BREMBO	4	40/44	32/Ø330		X284157	X284158
CLS 550		04.2006	12.2010	BREMBO	4	44	32		X284109	X284110
Tout / All / Alle / Tutti / Todos		10.2004		ATE	1	42	22		X225311	X225312

CLS (X218)

Tout / All / Alle / Tutti / Todos		10.2012		BREMBO	4	44	32		X284239	X284240
		10.2012		ATE	1	42	22		X225437	X225438

COUPE (C123)

230 C (123.043)		05.1977	04.1980	ATE	2	60	12,7		X224149	X224150
		05.1977	07.1979	ATE	2	60	12,7		X224123	X224124
		05.1977	04.1980	BENDIX	2	60	12,7		X254059	X254060
		05.1977	07.1979	BENDIX	2	60	12,7		X254047	X254048

X=1 : SNRA - X=2 : EAI - X=3 : SERA - X=4 : SEEAC - X=5 : NEOTO - X=6 : STARTCAR

Affectations par Marques

Vehicule application - Zuordnung nach Marke und Fahrzeuge - Applicazione per marca e veicolo - Aplicacion por marca y vehiculo



MERCEDES-BENZ

COUPE (C123)

230 CE (123.243)		04.1980	12.1985	ATE	2	60	12,7		X224149	X224150
		04.1980	12.1985	BENDIX	2	60	12,7		X254059	X254060
280 C (123.050)		03.1977	07.1979	ATE	2	60	12,7		X224123	X224124
		03.1977	03.1980	BENDIX	2	60	12,7		X254059	X254060
		03.1977	07.1979	BENDIX	2	60	12,7		X254047	X254048
280 CE		03.1977	07.1979	ATE	2	60	12,7		X224123	X224124
		03.1977	11.1985	ATE	2	60	12,7		X224149	X224150
		03.1977	07.1979	BENDIX	2	60	12,7		X254047	X254048
		03.1977	11.1985	BENDIX	2	60	12,7		X254059	X254060
300 C Turbo-D (123.153)		09.1981	07.1985	ATE	2	60	12,7		X224149	X224150
		09.1981	07.1985	BENDIX	2	60	12,7		X254059	X254060

COUPE (C124)

220 CE (124.042)		10.1992	05.1993	GIRL-TRW	1	54	22		X374083	X374084
		10.1992	05.1993	ATE	2	35	9		X225053	X225054
		10.1992	05.1993	ATE	2	35	9/Ø258	2 axe pour plaquettes	X225125	X225126
		10.1992	05.1993	BENDIX	2	35	9		X255017	X255018
230 CE (124.043)		03.1987	08.1989	ATE	1	54	12		X224147	X224148
		03.1987	08.1989	GIRL-TRW	1	54	12		X374131	X374132
		03.1987	12.1992	GIRL-TRW	1	54	22		X374083	X374084
		03.1987	12.1992	ATE	2	35	9		X225053	X225054
		03.1987	12.1992	ATE	2	35	9/Ø258	2 axe pour plaquettes	X225125	X225126
		03.1987	12.1992	BENDIX	2	35	9		X255017	X255018
230 CE (124.043) CAT		06.1989	12.1992	ATE	1	54	12		X224147	X224148
		06.1989	12.1992	GIRL-TRW	1	54	12		X374131	X374132
		06.1989	12.1992	GIRL-TRW	1	54	22		X374083	X374084
		06.1989	12.1992	ATE	2	35	9		X225053	X225054
		06.1989	12.1992	ATE	2	35	9/Ø258	2 axe pour plaquettes	X225125	X225126
		06.1989	12.1992	BENDIX	2	35	9		X255017	X255018
300 CE		03.1987	12.1989	ATE	1	54	12		X224147	X224148
		03.1987	12.1989	GIRL-TRW	1	54	12		X374131	X374132
		03.1987	12.1989	ATE	2	35	9		X225053	X225054
		03.1987	12.1989	ATE	2	35	9/Ø258	2 axe pour plaquettes	X225125	X225126
		03.1987	12.1989	BENDIX	2	35	9		X255017	X255018
300 CE (124.050)		03.1987	08.1989	ATE	1	54	12		X224147	X224148
		03.1987	08.1989	GIRL-TRW	1	54	12		X374131	X374132
		03.1987	05.1993	GIRL-TRW	1	54	22		X374083	X374084
		03.1987	05.1993	ATE	2	35	9		X225053	X225054
		03.1987	05.1993	ATE	2	35	9/Ø258	2 axe pour plaquettes	X225125	X225126
		03.1987	05.1993	BENDIX	2	35	9		X255017	X255018
300 CE-24 (124.051)		09.1989	12.1992	ATE	4	^{38/42}	22		X224223	X224224
		09.1989	12.1992	ATE	2	38	9/Ø278	2 axe pour plaquettes	X225191	X225192

Affectations par Marques

Vehicule application - Zuordnung nach Marke und Fahrzeuge - Applicazione per marca e veicolo - Aplicacion por marca y vehiculo



MERCEDES-BENZ

COUPE (C124)

320 CE (124.052)		10.1992	05.1993	ATE	4	38/42	22		X224223	X224224
		10.1992	05.1993	ATE	4	42	25		X224253	X224254
		10.1992	05.1993	ATE	2	38	9/Ø278		2 axe pour plaquettes	X225191

COUPE (W111)

Tout / All / Alle / Tutti / Todos		01.1961	12.1971	ATE	2	57	12,7		X224057	X224058
		01.1965	12.1971	ATE	2	42	10		X225019	X225020

HECKFLOSSE (W110)

Tout / All / Alle / Tutti / Todos		09.1959	02.1968	ATE	2	57	12,7		X224057	X224058
-----------------------------------	--	---------	---------	-----	---	----	------	--	---------	---------

HECKFLOSSE (W111, W112)

Tout / All / Alle / Tutti / Todos		08.1959	12.1967	ATE	2	57	12,7		X224057	X224058
-----------------------------------	--	---------	---------	-----	---	----	------	--	---------	---------

KOMBI (S123)

200 T		11.1980	11.1985	ATE	2	60	12,7		X224149	X224150
		11.1980	11.1985	BENDIX	2	60	12,7		X254059	X254060
200 T (123.280)		11.1980	11.1985	ATE	2	60	12,7		X224149	X224150
		11.1980	11.1985	BENDIX	2	60	12,7		X254059	X254060
230 T (123.083)		09.1977	03.1980	ATE	2	60	12,7		X224149	X224150
		09.1977	07.1979	ATE	2	60	12,7		X224123	X224124
		09.1977	03.1980	BENDIX	2	60	12,7		X254059	X254060
		09.1977	07.1979	BENDIX	2	60	12,7		X254047	X254048
230 TE (123.283)		04.1980	11.1985	ATE	2	60	12,7		X224149	X224150
		04.1980	11.1985	BENDIX	2	60	12,7		X254059	X254060
240 T D		09.1977	02.1979	ATE	2	60	12,7		X224123	X224124
		09.1977	02.1979	BENDIX	2	60	12,7		X254047	X254048
240 T D (123.183)		03.1979	12.1985	ATE	2	60	12,7		X224123	X224124
		03.1979	12.1985	ATE	2	60	12,7		X224149	X224150
		03.1979	12.1985	BENDIX	2	60	12,7		X254047	X254048
		03.1979	12.1985	BENDIX	2	60	12,7		X254059	X254060
250 T (123.086)		05.1978	10.1979	ATE	2	60	12,7		X224123	X224124
		05.1978	10.1979	ATE	2	60	12,7		X224149	X224150
		05.1978	10.1979	BENDIX	2	60	12,7		X254047	X254048
		05.1978	10.1979	BENDIX	2	60	12,7		X254059	X254060
280 TE (123.093)		09.1977	07.1979	ATE	2	60	12,7		X224123	X224124
		09.1977	11.1985	ATE	2	60	12,7		X224149	X224150
		09.1977	07.1979	BENDIX	2	60	12,7		X254047	X254048
		09.1977	11.1985	BENDIX	2	60	12,7		X254059	X254060
300 T D (123.190)		09.1977	07.1979	ATE	2	60	12,7		X224123	X224124
		09.1977	11.1985	ATE	2	60	12,7		X224149	X224150
		09.1977	07.1979	BENDIX	2	60	12,7		X254047	X254048
		09.1977	11.1985	BENDIX	2	60	12,7		X254059	X254060
300 T Turbo-D (123.193)		10.1980	11.1985	ATE	2	60	12,7		X224149	X224150
		10.1980	11.1985	BENDIX	2	60	12,7		X254059	X254060
Tout / All / Alle / Tutti / Todos		09.1977	12.1985	ATE	2	42	10		X225139	X225140

X=1 : SNRA - X=2 : EAI - X=3 : SERA - X=4 : SEEC - X=5 : NEOTO - X=6 : STARTCAR

Affectations par Marques

Vehicule application - Zuordnung nach Marke und Fahrzeuge - Applicazione per marca e veicolo - Aplicacion por marca y vehiculo



MERCEDES-BENZ

KOMBI (S124)

200 E		11.1992	05.1993	ATE	1	54	12		X224147	X224148
		11.1992	05.1993	GIRL-TRW	1	54	12		X374131	X374132
		11.1992	05.1993	ATE	2	35	9		X225053	X225054
		11.1992	05.1993	ATE	2	35	9/Ø258	2 axe pour plaquettes	X225125	X225126
		11.1992	05.1993	BENDIX	2	35	9		X255017	X255018
200 T (124.080)		09.1985	05.1990	ATE	1	54	12		X224147	X224148
		09.1985	05.1990	GIRL-TRW	1	54	12		X374131	X374132
		09.1985	05.1990	ATE	2	35	9		X225053	X225054
		09.1985	05.1990	ATE	2	35	9/Ø258	2 axe pour plaquettes	X225125	X225126
		09.1985	05.1990	BENDIX	2	35	9		X255017	X255018
200 T D (124.180)		09.1985	08.1991	ATE	1	54	12		X224147	X224148
		09.1985	08.1991	GIRL-TRW	1	54	12		X374131	X374132
		09.1985	08.1991	ATE	2	35	9		X225053	X225054
		09.1985	08.1991	ATE	2	35	9/Ø258	2 axe pour plaquettes	X225125	X225126
		09.1985	08.1991	BENDIX	2	35	9		X255017	X255018
200 TE		09.1988	12.1989	ATE	1	54	12		X224147	X224148
		09.1988	12.1989	GIRL-TRW	1	54	12		X374131	X374132
		09.1988	12.1989	ATE	2	35	9		X225053	X225054
		09.1988	12.1989	ATE	2	35	9/Ø258	2 axe pour plaquettes	X225125	X225126
		09.1988	12.1989	BENDIX	2	35	9		X255017	X255018
200 TE (124.079)		05.1986	06.1993	GIRL-TRW	1	54	22		X374083	X374084
		05.1986	06.1993	ATE	2	35	9		X225053	X225054
		05.1986	06.1993	ATE	2	35	9/Ø258	2 axe pour plaquettes	X225125	X225126
		05.1986	06.1993	BENDIX	2	35	9		X255017	X255018
200 TE (124.081)		09.1988	08.1992	ATE	1	54	12		X224147	X224148
		09.1988	08.1992	GIRL-TRW	1	54	12		X374131	X374132
		09.1988	08.1992	ATE	2	35	9		X225053	X225054
		09.1988	08.1992	ATE	2	35	9/Ø258	2 axe pour plaquettes	X225125	X225126
		09.1988	08.1992	BENDIX	2	35	9		X255017	X255018
220 TE (124.082)		10.1992	05.1993	GIRL-TRW	1	54	22		X374083	X374084
230 TE (124.083)		09.1985	08.1992	ATE	1	54	12		X224147	X224148
		09.1985	08.1992	GIRL-TRW	1	54	12		X374131	X374132
		09.1985	08.1992	GIRL-TRW	1	54	22		X374083	X374084
		09.1985	08.1992	ATE	2	35	9		X225053	X225054
		09.1985	08.1992	ATE	2	35	9/Ø258	2 axe pour plaquettes	X225125	X225126
		09.1985	08.1992	BENDIX	2	35	9		X255017	X255018
230 TE (124.083) CAT		06.1989	08.1992	GIRL-TRW	1	54	22		X374083	X374084
		06.1989	08.1992	ATE	2	35	9		X225053	X225054
		06.1989	08.1992	ATE	2	35	9/Ø258	2 axe pour plaquettes	X225125	X225126
		06.1989	08.1992	BENDIX	2	35	9		X255017	X255018

Affectations par Marques

Vehicule application - Zuordnung nach Marke und Fahrzeuge - Applicazione per marca e veicolo - Aplicacion por marca y vehiculo



MERCEDES-BENZ

KOMBI (S124)

250 T D (124.185)		09.1985	06.1993	ATE	1	54	12			X224147	X224148
		09.1985	06.1993	GIRL-TRW	1	54	12			X374131	X374132
		09.1985	09.1989	ATE	2	35	9			X225053	X225054
		09.1985	09.1989	ATE	2	35	9/Ø258		2 axe pour plaquettes	X225125	X225126
		09.1985	06.1993	ATE	2	38	9/Ø278		2 axe pour plaquettes	X225191	X225192
		09.1985	06.1993	BENDIX	2	35	9			X255017	X255018
250 TD Turbo (124.188)		03.1988	07.1993	GIRL-TRW	1	54	22			X374083	X374084
		03.1988	07.1993	ATE	2	35	9			X225053	X225054
		03.1988	07.1993	ATE	2	35	9/Ø258		2 axe pour plaquettes	X225125	X225126
		03.1988	07.1993	BENDIX	2	35	9			X255017	X255018
260 TE FGST.		09.1985	08.1992	GIRL-TRW	1	54	22			X374083	X374084
		09.1985	08.1992	ATE	2	35	9			X225053	X225054
		09.1985	08.1992	ATE	2	35	9/Ø258		2 axe pour plaquettes	X225125	X225126
		09.1985	08.1992	BENDIX	2	35	9			X255017	X255018
280 TE (124.088)		10.1992	06.1993	ATE	4	38/42	22			X224223	X224224
		10.1992	06.1993	ATE	4	42	25			X224253	X224254
		10.1992	06.1993	ATE	2	42	9			X225085	X225086
300 T D (124.190)		09.1986	06.1993	ATE	1	54	12			X224147	X224148
		09.1986	06.1993	GIRL-TRW	1	54	12			X374131	X374132
		09.1986	06.1993	ATE	2	35	9			X225053	X225054
		09.1986	06.1993	ATE	2	35	9/Ø258		2 axe pour plaquettes	X225125	X225126
		09.1986	06.1993	BENDIX	2	35	9			X255017	X255018
300 T Turbo-D		09.1986	01.1989	GIRL-TRW	1	54	22			X374083	X374084
		09.1986	01.1989	ATE	2	35	9			X225053	X225054
		09.1986	01.1989	ATE	2	35	9/Ø258		2 axe pour plaquettes	X225125	X225126
		09.1986	01.1989	BENDIX	2	35	9			X255017	X255018
300 T Turbo-D (124.193)		01.1989	06.1993	GIRL-TRW	1	54	22			X374083	X374084
		01.1989	06.1993	ATE	2	35	9			X225053	X225054
		01.1989	06.1993	ATE	2	35	9/Ø258		2 axe pour plaquettes	X225125	X225126
		01.1989	06.1993	BENDIX	2	35	9			X255017	X255018
300 T Turbo-D 4-matic (124.393)		09.1986	06.1993	GIRL-TRW	1	54	22			X374169	X374170
		09.1986	06.1993	ATE	2	35	9			X225053	X225054
		09.1986	06.1993	ATE	2	35	9/Ø258		2 axe pour plaquettes	X225125	X225126
		09.1986	06.1993	BENDIX	2	35	9			X255017	X255018
300 TE (124.090)		01.1986	08.1992	GIRL-TRW	1	54	22			X374083	X374084
		01.1986	08.1992	ATE	2	35	9			X225053	X225054
		01.1986	08.1992	ATE	2	35	9/Ø258		2 axe pour plaquettes	X225125	X225126
		01.1986	08.1992	BENDIX	2	35	9			X255017	X255018
300 TE 4-matic (124.290)		09.1986	08.1989	GIRL-TRW	1	54	22			X374169	X374170
		09.1986	08.1989	ATE	2	35	9			X225053	X225054
		09.1986	08.1989	ATE	2	35	9/Ø258		2 axe pour plaquettes	X225125	X225126
		09.1986	06.1993	BENDIX	2	35	9			X255017	X255018

Affectations par Marques

Vehicule application - Zuordnung nach Marke und Fahrzeuge - Applicazione per marca e veicolo - Aplicacion por marca y vehiculo



MERCEDES-BENZ

KOMBI (S124)

300 TE-24 (124.091)		09.1989	08.1992	ATE	4	38/42	22		X224223	X224224
		09.1989	08.1992	ATE	2	42	9		X225085	X225086
320 TE (124.092)		10.1992	06.1993	ATE	4	42	25		X224253	X224254
		10.1992	06.1993	ATE	2	42	9		X225085	X225086

MB 100, 140 (631)

Tout / All / Alle / Tutti / Todos		09.1987	02.1996	BENDIX	2	48	16		X254133	X254134
-----------------------------------	--	---------	---------	--------	---	----	----	--	---------	---------

MB 160, 180 (631)

Tout / All / Alle / Tutti / Todos		09.1987	02.1996	BENDIX	2	52	16		X254141	X254142
-----------------------------------	--	---------	---------	--------	---	----	----	--	---------	---------

PAGODE (W113)

Tout / All / Alle / Tutti / Todos		01.1963	03.1971	ATE	2	57	12,7		X224057	X224058
-----------------------------------	--	---------	---------	-----	---	----	------	--	---------	---------

SL (C107) COUPE

380 SLC		08.1981	08.1984	ATE	2	60	22		X224289	X224290
		08.1981	08.1984	ATE	2	38	10		X225049	X225050

SL (R107)

280 SL (107.042)		08.1974	07.1985	ATE	2	60	22		X224289	X224290
300 SL (107.041)		09.1985	08.1989	ATE	4	40	22		X224225	X224226
350 SL (107.043)		05.1971	02.1980	ATE	2	57	22		X224481	X224482
		05.1971	02.1980	ATE	2	60	22		X224397	X224398
		05.1971	02.1980	BENDIX	2	38	10		X255005	X255006
		05.1971	02.1980	GIRL-TRW	2	38	10		X375007	X375008
380 SL (107.045)		09.1980	08.1981	ATE	2	60	22		X224289	X224290
		09.1980	08.1981	ATE	2	38	10/Ø279		X225049	X225050
420 SL (107.047)		01.1986	08.1989	ATE	4	40	22		X224225	X224226
		01.1986	08.1989	ATE	2	38	10/Ø279		X225049	X225050
		01.1986	08.1989	BENDIX	2	38	10		X255019	X255020
450 SL (107.044)		10.1972	10.1980	ATE	2	60	22		X224289	X224290
		10.1972	10.1980	ATE	2	60	22		X224397	X224398
500 SL (107.046)		05.1980	08.1989	ATE	2	60	22		X224289	X224290
		05.1980	08.1989	ATE	2	38	10/Ø279		X225049	X225050
		01.1986	09.1987	BENDIX	2	38	10		X255019	X255020

SL (R129)

280 (129.058)		08.1993	12.1994	ATE	2	57	28		X224251	X224252	
		08.1993	10.2001	ATE	4	38/42	28		X224273	X224274	
		08.1993	12.1994	GIRL-TRW	4	40/44	28		X374259	X374260	
		08.1993	10.2001	ATE	2	36	10		X225221	X225222	
		08.1993	12.1994	ATE	2	38	9/Ø278		2 axe pour plaquettes	X225191	X225192
		08.1993	05.1998	ATE	2	42	20/Ø300		X225165	X225166	
280 (129.059)		05.1998	10.2001	ATE	4	38/42	28		X224273	X224274	
		05.1998	10.2001	ATE	2	36	10		X225221	X225222	
		05.1998	10.2001	ATE	2	42	20/Ø300		X225165	X225166	

Affectations par Marques

Vehicule application - Zuordnung nach Marke und Fahrzeuge - Applicazione per marca e veicolo - Aplicacion por marca y vehiculo



MERCEDES-BENZ

SL (R129)

300 SL (129.060)		03.1989	08.1993	ATE	4	38/42	28		X224273	X224274
		03.1989	08.1993	ATE	2	38	9/Ø278	2 axe pour plaquettes	X225191	X225192
300 SL-24 (129.061)		03.1989	07.1993	ATE	4	38/42	28		X224273	X224274
		03.1989	07.1993	ATE	2	38	9/Ø278	2 axe pour plaquettes	X225191	X225192
320 (129.063)		09.1993	10.2001	ATE	2	57	28		X224251	X224252
		09.1993	10.2001	ATE	4	38/42	28		X224273	X224274
		09.1993	10.2001	GIRL-TRW	4	40/44	28		X374259	X374260
		09.1993	10.2001	ATE	2	36	10		X225221	X225222
		09.1993	10.2001	ATE	2	38	9/Ø278	2 axe pour plaquettes	X225191	X225192
		09.1993	10.2001	ATE	2	42	20/Ø300		X225165	X225166
320 (129.064)		05.1998	10.2001	ATE	4	38/42	28		X224273	X224274
		05.1998	10.2001	ATE	2	36	10		X225221	X225222
		05.1998	10.2001	ATE	2	42	20/Ø300		X225165	X225166
500 (129.067)		09.1992	12.1994	ATE	2	57	28		X224251	X224252
		09.1992	10.2001	ATE	4	38/42	28		X224273	X224274
		09.1992	12.1994	GIRL-TRW	4	40/44	28		X374259	X374260
		09.1992	10.2001	ATE	2	36	10		X225221	X225222
		09.1992	12.1994	ATE	2	38	9/Ø278	2 axe pour plaquettes	X225191	X225192
		09.1992	05.1998	ATE	2	42	20/Ø300		X225165	X225166
500 (129.068)		05.1998	10.2001	ATE	2	42	20/Ø300		X225165	X225166
500 SL (129.066)		09.1989	08.1992	ATE	4	38/42	28		X224273	X224274
		09.1989	08.1992	ATE	2	38	9/Ø278	2 axe pour plaquettes	X225191	X225192
60 AMG (129.067)		05.1997	10.2001	ATE	2	42	20/Ø300		X225165	X225166
600 (129.076)		07.1992	10.2001	ATE	2	57	28		X224251	X224252
		07.1992	10.2001	GIRL-TRW	4	40/44	28		X374259	X374260
		07.1992	10.2001	ATE	2	42	20/Ø300		X225165	X225166
600 SL		02.1992	05.1993	ATE	2	57	28		X224251	X224252
		02.1992	05.1993	GIRL-TRW	4	40/44	28		X374259	X374260
		02.1992	05.1993	ATE	2	42	20/Ø300		X225165	X225166

SL (R230)

350		04.2008	01.2012	ATE	1	42	22		X225311	X225312
350 (230.467)		03.2003	07.2005	BREMBO	4	40/44	28/Ø312		X284195	X284196
		03.2003	07.2005	ATE	1	42	11		X225331	X225332
500		03.2006	01.2012	BREMBO	4	44	32		X284109	X284110
500 (230.475)		10.2001	12.2005	BREMBO	4	40/44	32/Ø330		X284157	X284158
		10.2001	12.2005	ATE	1	42	22		X225311	X225312

SLK (R170)

200 (170.435)		09.1996	09.1999	ATE	1	57	25/Ø288		X224437	X224438
		09.1996	09.1999	ATE	2	36	9	1 axe pour plaquettes	X225223	X225224
		09.1996	09.1999	ATE	2	38	9/Ø278	2 axe pour plaquettes	X225191	X225192
200 Kompressor (170.444)		03.2000	09.2003	ATE	1	57	25/Ø288		X224437	X224438
		03.2000	09.2003	ATE	2	36	9	1 axe pour plaquettes	X225223	X225224

X=1 : SNRA - X=2 : EAI - X=3 : SERA - X=4 : SEEAC - X=5 : NEOTO - X=6 : STARTCAR

Affectations par Marques

Vehicule application - Zuordnung nach Marke und Fahrzeuge - Applicazione per marca e veicolo - Aplicacion por marca y vehiculo



MERCEDES-BENZ

SLK (R170)

200 Kompressor (170.445)		10.1996	03.2000	ATE	1	57	25/Ø288		X224437	X224438
		10.1996	03.2000	ATE	2	36	9	1 axe pour plaquettes	X225223	X225224
		10.1996	03.2000	ATE	2	38	9/Ø278	2 axe pour plaquettes	X225191	X225192
230 Kompressor (170.447)		09.1996	03.2000	ATE	1	57	25/Ø288		X224437	X224438
		09.1996	03.2000	ATE	2	36	9	1 axe pour plaquettes	X225223	X225224
		09.1996	03.2000	ATE	2	38	9/Ø278	2 axe pour plaquettes	X225191	X225192
230 Kompressor (170.449)		03.2000	04.2004	ATE	1	57	25/Ø288		X224437	X224438
		03.2000	04.2004	ATE	2	36	9	1 axe pour plaquettes	X225223	X225224
		03.2000	04.2004	ATE	2	38	9/Ø278	2 axe pour plaquettes	X225191	X225192
32 AMG Kompressor (170.466)		03.2001	04.2004	ATE	2	44	32		X224885	X224886
		03.2001	04.2004	ATE	2	44	32/Ø330		X224897	X224898
		03.2001	04.2004	ATE	2	42	20/Ø300		X225165	X225166
320 (170.465)		03.2000	04.2004	ATE	1	57	28/Ø300		X224439	X224440
		03.2000	04.2004	ATE	2	36	9	1 axe pour plaquettes	X225223	X225224

SLK (R171)

200 Kompressor (171.442)		03.2004	02.2011	BREMBO	2	57	28/Ø330		X284121	X284122
		03.2004	02.2011	GIRL-TRW	1	57	25/Ø288		X374607	X374608
		03.2004	02.2011	ATE	2	36	10/Ø290	1 axe pour plaquettes	X225313	X225314
		03.2004	02.2011	ATE	2	36	9/Ø278	1 axe pour plaquettes	X225249	X225250
200 Kompressor (171.445)		01.2008	02.2011	BREMBO	2	57	28/Ø330		X284121	X284122
		01.2008	02.2011	GIRL-TRW	1	57	25/Ø288		X374607	X374608
		01.2008	02.2011	ATE	2	36	10/Ø290	1 axe pour plaquettes	X225313	X225314
		01.2008	02.2011	ATE	2	36	9/Ø278	1 axe pour plaquettes	X225249	X225250
280 (171.454)		01.2005	02.2011	BREMBO	2	57	28/Ø330		X284121	X284122
		01.2005	02.2011	GIRL-TRW	1	57	28/Ø300		X374605	X374606
		01.2005	02.2011	ATE	2	36	10/Ø290	1 axe pour plaquettes	X225313	X225314
		01.2005	02.2011	ATE	2	36	9/Ø278	1 axe pour plaquettes	X225249	X225250
300 (171.454)		04.2009	02.2011	BREMBO	2	57	28/Ø330		X284121	X284122
		04.2009	02.2011	GIRL-TRW	1	57	28/Ø300		X374605	X374606
		04.2009	02.2011	ATE	2	36	10/Ø290	1 axe pour plaquettes	X225313	X225314
		04.2009	02.2011	ATE	2	36	9/Ø278	1 axe pour plaquettes	X225249	X225250
350 (171.456)		06.2004	02.2011	BREMBO	2	57	28/Ø330		X284121	X284122
		06.2004	01.2006	BREMBO	4	40/44	28/Ø330		X284245	X284246
		06.2004	02.2011	ATE	2	36	10/Ø290	1 axe pour plaquettes	X225313	X225314
350 (171.458)		01.2008	02.2011	BREMBO	2	57	28/Ø330		X284121	X284122
		01.2008	02.2011	ATE	2	36	10/Ø290	1 axe pour plaquettes	X225313	X225314
55 AMG (171.473)		06.2004	02.2011	BREMBO	4	40/44	30/Ø345		X284221	X284222

SLK (R172)

200 (172.448)		02.2011		GIRL-TRW	1	60	28/Ø295		X374771	X374772
		02.2011		GIRL-TRW	1	60	32/Ø344		X374773	X374774
250 (172.447)		02.2011		GIRL-TRW	1	60	28/Ø295		X374771	X374772
		02.2011		GIRL-TRW	1	60	32/Ø322		X374769	X374770
		02.2011		GIRL-TRW	1	60	32/Ø344		X374773	X374774

X=1 : SNRA - X=2 : EAI - X=3 : SERA - X=4 : SEEC - X=5 : NEOTO - X=6 : STARTCAR

Affectations par Marques

Vehicule application - Zuordnung nach Marke und Fahrzeuge - Applicazione per marca e veicolo - Aplicacion por marca y vehiculo



MERCEDES-BENZ

SLK (R172)

250 CDI (172.403)		01.2012		GIRL-TRW	1	60	32/Ø322		X374769	X374770
		01.2012		GIRL-TRW	1	60	32/Ø344		X374773	X374774
350 (172.457)		02.2011		GIRL-TRW	1	60	32/Ø344		X374773	X374774
Tout / All / Alle / Tutti / Todos		02.2011		GIRL-TRW	1	36	10/Ø300		X377069	X377070

SPRINTER (901, 902) 2-t

208 CDI		04.2000	05.2006	ATE	1	60	22		X224489	X224490
		04.2000	05.2006	ATE	1	60	22		X224491	X224492
		04.2000	05.2006	ATE	1	45	12		X225211	X225212
208 D		01.1995	04.2000	ATE	1	60	22		X224489	X224490
		01.1995	04.2000	ATE	1	60	22		X224491	X224492
		01.1995	04.2000	BOSCH	2	45	22		X274013	X274014
		01.1995	04.2000	PERROT	2	44	22		X614009	X614010
		01.1995	04.2000	ATE	1	45	12		X225211	X225212
		01.1995	04.2000	PERROT	2	44	22		X615001	X615002
210 D		01.1997	04.2000	ATE	1	60	22		X224489	X224490
		01.1997	04.2000	ATE	1	60	22		X224491	X224492
		01.1997	04.2000	BOSCH	2	45	22		X274013	X274014
		01.1997	04.2000	PERROT	2	44	22		X614009	X614010
		01.1997	04.2000	ATE	1	45	12		X225211	X225212
		01.1997	04.2000	PERROT	2	44	22		X615001	X615002
211 CDI		04.2000	05.2006	ATE	1	60	22		X224489	X224490
		04.2000	05.2006	ATE	1	60	22		X224491	X224492
		04.2000	05.2006	ATE	1	45	12		X225211	X225212
212 D		02.1995	04.2000	ATE	1	60	22		X224489	X224490
		02.1995	04.2000	ATE	1	60	22		X224491	X224492
		02.1995	04.2000	BOSCH	2	45	22		X274013	X274014
		02.1995	04.2000	PERROT	2	44	22		X614009	X614010
		02.1995	04.2000	ATE	1	45	12		X225211	X225212
		02.1995	04.2000	PERROT	2	44	22		X615001	X615002
213 CDI		04.2000	05.2006	ATE	1	60	22		X224489	X224490
		04.2000	05.2006	ATE	1	60	22		X224491	X224492
		04.2000	05.2006	ATE	1	45	12		X225211	X225212
214		02.1995	05.2006	ATE	1	60	22		X224489	X224490
		02.1995	05.2006	ATE	1	60	22		X224491	X224492
		02.1995	08.2000	BOSCH	2	45	22		X274013	X274014
		02.1995	08.2000	PERROT	2	44	22		X614009	X614010
		02.1995	05.2006	ATE	1	45	12		X225211	X225212
		02.1995	05.2006	PERROT	2	44	22		X615001	X615002
214 NGT		04.2000	05.2006	ATE	1	60	22		X224489	X224490
		04.2000	05.2006	ATE	1	60	22		X224491	X224492
		04.2000	05.2006	ATE	1	45	12		X225211	X225212

Affectations par Marques

Vehicule application - Zuordnung nach Marke und Fahrzeuge - Applicazione per marca e veicolo - Aplicacion por marca y vehiculo



MERCEDES-BENZ

SPRINTER (901, 902) 2-t

216 CDI		04.2000	05.2006	ATE	1	60	22		X224489	X224490
		04.2000	05.2006	ATE	1	60	22		X224491	X224492
		04.2000	05.2006	ATE	1	45	12		X225211	X225212

SPRINTER (903) 3-t

2.9 TDi		01.1997	12.1999	ATE	1	60	22		X224489	X224490
		01.1997	12.1999	ATE	1	60	22		X224491	X224492
		01.1997	12.1999	BOSCH	2	45	22		X274013	X274014
		01.1997	12.1999	BOSCH	2	45	22		X274061	X274062
		01.1997	12.1999	PERROT	2	44	22		X614009	X614010
		01.1997	12.1999	ATE	1	52	16		X225133	X225134
		01.1997	12.1999	BOSCH	1	52	16		X275001	X275002
		01.1997	12.1999	BOSCH	2	45	22		X275069	X275070
308 CDI		04.2000	05.2006	ATE	1	60	22		X224489	X224490
		04.2000	05.2006	ATE	1	60	22		X224491	X224492
		04.2000	05.2006	ATE	1	52	16		X225133	X225134
		04.2000	05.2006	BOSCH	1	52	16		X275001	X275002
308 D		02.1995	04.2000	ATE	1	60	22		X224489	X224490
		02.1995	04.2000	ATE	1	60	22		X224491	X224492
		02.1995	04.2000	BOSCH	2	45	22		X274013	X274014
		02.1995	04.2000	PERROT	2	44	22		X614009	X614010
		02.1995	04.2000	ATE	1	52	16		X225133	X225134
		02.1995	04.2000	BOSCH	1	52	16		X275001	X275002
		02.1995	04.2000	PERROT	2	44	22		X615001	X615002
		02.1995	04.2000	ATE	1	60	22		X224489	X224490
308 D (903.371, 903.372, 903.373)		03.1997	04.2000	ATE	1	60	22		X224489	X224490
		03.1997	04.2000	ATE	1	60	22		X224491	X224492
		03.1997	04.2000	BOSCH	2	45	22		X274013	X274014
		03.1997	04.2000	PERROT	2	44	22		X614009	X614010
		03.1997	04.2000	ATE	1	52	16		X225133	X225134
		03.1997	04.2000	BOSCH	1	52	16		X275001	X275002
		03.1997	04.2000	PERROT	2	44	22		X615001	X615002
		02.1995	04.2000	ATE	1	60	22		X224489	X224490
308 D 2.3		02.1995	04.2000	ATE	1	60	22		X224491	X224492
		02.1995	04.2000	BOSCH	2	45	22		X274013	X274014
		02.1995	04.2000	PERROT	2	44	22		X614009	X614010
		02.1995	04.2000	ATE	1	52	16		X225133	X225134
		02.1995	04.2000	BOSCH	1	52	16		X275001	X275002
		02.1995	04.2000	PERROT	2	44	22		X615001	X615002

Affectations par Marques

Vehicule application - Zuordnung nach Marke und Fahrzeuge - Applicazione per marca e veicolo - Aplicacion por marca y vehiculo



MERCEDES-BENZ

SPRINTER (903) 3-t

310 D 4x4		05.1997	08.2002	ATE	1	60	22		X224489	X224490
		05.1997	08.2002	ATE	1	60	22		X224491	X224492
		05.1997	08.2002	BOSCH	2	45	22		X274013	X274014
		05.1997	08.2002	PERROT	2	44	22		X614009	X614010
		05.1997	08.2002	ATE	1	52	16		X225133	X225134
		05.1997	08.2002	BOSCH	1	52	16		X275001	X275002
		05.1997	08.2002	PERROT	2	44	22		X615001	X615002
310 D 2.9		02.1995	04.2000	ATE	1	60	22		X224489	X224490
		02.1995	04.2000	ATE	1	60	22		X224491	X224492
		01.1997	04.2000	BOSCH	2	45	22		X274013	X274014
		01.1997	04.2000	PERROT	2	44	22		X614009	X614010
		02.1995	04.2000	ATE	1	52	16		X225133	X225134
		02.1995	04.2000	BOSCH	1	52	16		X275001	X275002
		01.1997	04.2000	PERROT	2	44	22		X615001	X615002
311 CDI		04.2000	05.2006	ATE	1	60	22		X224489	X224490
		04.2000	05.2006	ATE	1	60	22		X224491	X224492
		04.2000	05.2006	ATE	1	52	16		X225133	X225134
		04.2000	05.2006	BOSCH	1	52	16		X275001	X275002
311 CDI 4x4		08.2002	05.2006	ATE	1	60	22		X224489	X224490
		08.2002	05.2006	ATE	1	60	22		X224491	X224492
		08.2002	05.2006	ATE	1	52	16		X225133	X225134
		08.2002	05.2006	BOSCH	1	52	16		X275001	X275002
312 D 2.9		02.1995	04.2000	ATE	1	60	22		X224489	X224490
		02.1995	04.2000	ATE	1	60	22		X224491	X224492
		02.1995	04.2000	BOSCH	2	45	22		X274013	X274014
		02.1995	04.2000	PERROT	2	44	22		X614009	X614010
		02.1995	04.2000	ATE	1	52	16		X225133	X225134
		02.1995	04.2000	BOSCH	1	52	16		X275001	X275002
		02.1995	04.2000	PERROT	2	44	22		X615001	X615002
312 D 2.9 4x4		05.1997	04.2000	ATE	1	60	22		X224489	X224490
		05.1997	04.2000	ATE	1	60	22		X224491	X224492
		05.1997	04.2000	BOSCH	2	45	22		X274013	X274014
		05.1997	04.2000	PERROT	2	44	22		X614009	X614010
		05.1997	04.2000	ATE	1	52	16		X225133	X225134
		05.1997	04.2000	BOSCH	1	52	16		X275001	X275002
		05.1997	08.2002	PERROT	2	44	22		X615001	X615002
		05.1997	08.2002	PERROT	2	44	22		X615001	X615002
313 CDI		04.2000	05.2006	ATE	1	60	22		X224489	X224490
		04.2000	05.2006	ATE	1	60	22		X224491	X224492
		04.2000	05.2006	ATE	1	52	16		X225133	X225134
		04.2000	05.2006	BOSCH	1	52	16		X275001	X275002
313 CDI 4x4		08.2002	05.2006	ATE	1	60	22		X224489	X224490
		08.2002	05.2006	ATE	1	60	22		X224491	X224492
		08.2002	05.2006	ATE	1	52	16		X225133	X225134
		08.2002	05.2006	BOSCH	1	52	16		X275001	X275002

X=1 : SNRA - X=2 : EAI - X=3 : SERA - X=4 : SEEC - X=5 : NEOTO - X=6 : STARTCAR

Affectations par Marques

Vehicule application - Zuordnung nach Marke und Fahrzeuge - Applicazione per marca e veicolo - Aplicacion por marca y vehiculo



MERCEDES-BENZ

SPRINTER (903) 3-t

314		02.1995	05.2006	ATE	1	60	22		X224489	X224490
		02.1995	05.2006	ATE	1	60	22		X224491	X224492
		02.1995	05.2006	BOSCH	2	45	22		X274013	X274014
		02.1995	05.2006	PERROT	2	44	22		X614009	X614010
		02.1995	05.2006	ATE	1	52	16		X225133	X225134
		02.1995	05.2006	BOSCH	1	52	16		X275001	X275002
		02.1995	05.2006	PERROT	2	44	22		X615001	X615002

314 4x4		08.2002	05.2006	ATE	1	60	22		X224489	X224490
		08.2002	05.2006	ATE	1	60	22		X224491	X224492
		08.2002	05.2006	BOSCH	2	45	22		X274013	X274014
		08.2002	05.2006	PERROT	2	44	22		X614009	X614010
		08.2002	05.2006	ATE	1	52	16		X225133	X225134
		08.2002	05.2006	BOSCH	1	52	16		X275001	X275002
		08.2002	05.2006	PERROT	2	44	22		X615001	X615002

314 NGT		04.2000	05.2006	ATE	1	60	22		X224489	X224490
		04.2000	05.2006	ATE	1	60	22		X224491	X224492
		04.2000	05.2006	ATE	1	52	16		X225133	X225134
		04.2000	05.2006	BOSCH	1	52	16		X275001	X275002

316 CDI		04.2000	05.2006	ATE	1	60	22		X224489	X224490
		04.2000	05.2006	ATE	1	60	22		X224491	X224492
		04.2000	05.2006	BOSCH	2	45	22		X274013	X274014
		04.2000	05.2006	PERROT	2	44	22		X614009	X614010
		04.2000	05.2006	ATE	1	52	16		X225133	X225134
		04.2000	05.2006	BOSCH	1	52	16		X275001	X275002

316 CDI 4x4		08.2002	05.2006	ATE	1	60	22		X224489	X224490
		08.2002	05.2006	ATE	1	60	22		X224491	X224492
		08.2002	05.2006	ATE	1	52	16		X225133	X225134
		08.2002	05.2006	BOSCH	1	52	16		X275001	X275002

SPRINTER (904) 4-t

408 CDI		04.2000	05.2006	ATE	1	60	22		X224489	X224490
		04.2000	05.2006	ATE	1	60	22		X224491	X224492
		04.2000	05.2006	BOSCH	2	45	22		X274013	X274014
		04.2000	05.2006	BOSCH	2	45	22		X274061	X274062
		04.2000	05.2006	PERROT	2	44	22		X614009	X614010
		04.2000	05.2006	PERROT	2	44	22		X615001	X615002

408 D		02.1996	04.2000	ATE	1	60	22		X224489	X224490
		02.1996	04.2000	ATE	1	60	22		X224491	X224492
		02.1996	04.2000	BOSCH	2	45	22		X274013	X274014
		02.1996	04.2000	BOSCH	2	45	22		X274061	X274062
		02.1996	04.2000	PERROT	2	44	22		X614009	X614010
		02.1996	05.2006	PERROT	2	44	22		X615001	X615002

Affectations par Marques

Vehicule application - Zuordnung nach Marke und Fahrzeuge - Applicazione per marca e veicolo - Aplicacion por marca y vehiculo



MERCEDES-BENZ

SPRINTER (904) 4-t

410 D		02.1996	05.2006	ATE	1	60	22		X224489	X224490
		02.1996	05.2006	ATE	1	60	22		X224491	X224492
		02.1996	05.2006	BOSCH	2	45	22		X274013	X274014
		02.1996	05.2006	BOSCH	2	45	22		X274061	X274062
		02.1996	05.2006	PERROT	2	44	22		X614009	X614010
		02.1996	05.2006	PERROT	2	44	22		X615001	X615002
410 D 4x4		05.1997	05.2006	ATE	1	60	22		X224489	X224490
		05.1997	05.2006	ATE	1	60	22		X224491	X224492
		05.1997	05.2006	BOSCH	2	45	22		X274013	X274014
		05.1997	05.2006	PERROT	2	44	22		X614009	X614010
		05.1997	05.2006	ATE	1	45	12		X225211	X225212
		05.1997	05.2006	PERROT	2	44	22		X615001	X615002
411 CDI		04.2000	05.2006	ATE	1	60	22		X224489	X224490
		04.2000	05.2006	ATE	1	60	22		X224491	X224492
		04.2000	05.2006	BOSCH	2	45	22		X274013	X274014
		04.2000	05.2006	BOSCH	2	45	22		X274061	X274062
		04.2000	05.2006	PERROT	2	44	22		X614009	X614010
		04.2000	05.2006	PERROT	2	44	22		X615001	X615002
411 CDI 4x4		04.2000	05.2006	ATE	1	60	22		X224489	X224490
		04.2000	05.2006	ATE	1	60	22		X224491	X224492
		04.2000	05.2006	BOSCH	2	45	22		X274013	X274014
		04.2000	05.2006	BOSCH	2	45	22		X274061	X274062
		04.2000	05.2006	PERROT	2	44	22		X614009	X614010
		04.2000	05.2006	PERROT	2	44	22		X615001	X615002
412 D		02.1996	05.2006	ATE	1	60	22		X224489	X224490
		02.1996	05.2006	ATE	1	60	22		X224491	X224492
		02.1996	05.2006	BOSCH	2	45	22		X274013	X274014
		02.1996	05.2006	BOSCH	2	45	22		X274061	X274062
		02.1996	05.2006	PERROT	2	44	22		X614009	X614010
		02.1996	05.2006	PERROT	2	44	22		X615001	X615002
412 D 4x4		05.1997	05.2006	ATE	1	60	22		X224489	X224490
		05.1997	05.2006	ATE	1	60	22		X224491	X224492
		05.1997	05.2006	BOSCH	2	45	22		X274013	X274014
		05.1997	05.2006	BOSCH	2	45	22		X274061	X274062
		05.1997	05.2006	PERROT	2	44	22		X614009	X614010
		05.1997	05.2006	PERROT	2	44	22		X615001	X615002
413 CDI		04.2000	05.2006	ATE	1	60	22		X224489	X224490
		04.2000	05.2006	ATE	1	60	22		X224491	X224492
		04.2000	05.2006	BOSCH	2	45	22		X274013	X274014
		04.2000	05.2006	BOSCH	2	45	22		X274061	X274062
		04.2000	05.2006	PERROT	2	44	22		X614009	X614010
		04.2000	05.2006	PERROT	2	44	22		X615001	X615002

Affectations par Marques

Vehicule application - Zuordnung nach Marke und Fahrzeuge - Applicazione per marca e veicolo - Aplicacion por marca y vehiculo



MERCEDES-BENZ

SPRINTER (904) 4-t

413 CDI 4x4		04.2000	05.2006	ATE	1	60	22		X224489	X224490
		04.2000	05.2006	ATE	1	60	22		X224491	X224492
		04.2000	05.2006	BOSCH	2	45	22		X274013	X274014
		04.2000	05.2006	BOSCH	2	45	22		X274061	X274062
		04.2000	05.2006	PERROT	2	44	22		X614009	X614010
		04.2000	05.2006	PERROT	2	44	22		X615001	X615002

414		02.1996	05.2006	ATE	1	60	22		X224489	X224490
		02.1996	05.2006	ATE	1	60	22		X224491	X224492
		02.1996	05.2006	BOSCH	2	45	22		X274013	X274014
		02.1996	05.2006	BOSCH	2	45	22		X274061	X274062
		02.1996	05.2006	PERROT	2	44	22		X614009	X614010
		02.1996	05.2006	PERROT	2	44	22		X615001	X615002

414 4x4		05.1997	05.2006	ATE	1	60	22		X224489	X224490
		05.1997	05.2006	ATE	1	60	22		X224491	X224492
		05.1997	05.2006	BOSCH	2	45	22		X274013	X274014
		05.1997	05.2006	BOSCH	2	45	22		X274061	X274062
		05.1997	05.2006	PERROT	2	44	22		X614009	X614010
		05.1997	05.2006	PERROT	2	44	22		X615001	X615002

416 CDI		04.2000	05.2006	ATE	1	60	22		X224489	X224490
		04.2000	05.2006	ATE	1	60	22		X224491	X224492
		04.2000	05.2006	BOSCH	2	45	22		X274013	X274014
		04.2000	05.2006	BOSCH	2	45	22		X274061	X274062
		04.2000	05.2006	PERROT	2	44	22		X614009	X614010
		04.2000	05.2006	PERROT	2	44	22		X615001	X615002

416 CDI 4x4		04.2000	05.2006	ATE	1	60	22		X224489	X224490
		04.2000	05.2006	ATE	1	60	22		X224491	X224492
		04.2000	05.2006	BOSCH	2	45	22		X274013	X274014
		04.2000	05.2006	BOSCH	2	45	22		X274061	X274062
		04.2000	05.2006	PERROT	2	44	22		X614009	X614010
		04.2000	05.2006	PERROT	2	44	22		X615001	X615002

SPRINTER (905)

Tout / All / Alle / Tutti / Todos		04.2001		BREMBO	2	52	26		X284101	X284102
-----------------------------------	--	---------	--	--------	---	----	----	--	---------	---------

SPRINTER (906) 3,5-t

Tout / All / Alle / Tutti / Todos		06.2006		BREMBO	2	48	28		X284099	X284100
		06.2006		BOSCH	1	51	16		X275045	X275046

SPRINTER (906) 3-t

Tout / All / Alle / Tutti / Todos		06.2006		BREMBO	2	48	28		X284099	X284100
		06.2006		BOSCH	1	51	16		X275045	X275046

SPRINTER (906) 4,6-t

411 CDI (906.153, 906.155, 906.253, 906.2		06.2009		BREMBO	2	52	28		X284087	X284088
		06.2009		BOSCH	2	48	28		X275039	X275040

Affectations par Marques

Vehicule application - Zuordnung nach Marke und Fahrzeuge - Applicazione per marca e veicolo - Aplicacion por marca y vehiculo



MERCEDES-BENZ

SPRINTER (906) 4,6-t

411 CDI (906.653, 906.655, 906.657)		06.2009		BREMBO	2	52	28		X284087	X284088
		06.2009		BOSCH	1	51	16		X275045	X275046
		06.2009		BOSCH	2	48	28		X275039	X275040
413 CDI (906.153, 906.155, 906.253, 906.2)		06.2006		BREMBO	2	52	28		X284087	X284088
		06.2006		BOSCH	1	51	16		X275045	X275046
413 CDI (906.653, 906.655, 906.657)		06.2006		BREMBO	2	52	28		X284087	X284088
		06.2006		BOSCH	1	51	16		X275045	X275046
		06.2006		BOSCH	2	48	28		X275039	X275040
415 CDI (906.153, 906.155, 906.253, 906.2)		06.2006	12.2010	BREMBO	2	52	28		X284087	X284088
		06.2006	12.2010	BOSCH	2	48	28		X275039	X275040
415 CDI (906.653, 906.655, 906.657)		06.2009	12.2010	BREMBO	2	52	28		X284087	X284088
416 CDI (906.153, 906.155, 906.253, 906.2)		03.2009		BREMBO	2	52	28		X284087	X284088
		03.2009		BOSCH	1	51	16		X275045	X275046
		03.2009		BOSCH	2	48	28		X275039	X275040
416 CDI (906.653, 906.655, 906.657)		03.2009		BOSCH	2	45	22		X274013	X274014
		03.2009		BOSCH	2	45	22		X274061	X274062
		03.2009		BREMBO	2	52	28		X284087	X284088
		03.2009		PERROT	2	44	22		X614009	X614010
		03.2009		PERROT	2	44	22		X615001	X615002
418 CDI (906.153, 906.155, 906.253, 906.2)		06.2006	12.2010	BREMBO	2	52	28		X284087	X284088
		06.2006	12.2010	BOSCH	2	48	28		X275039	X275040
418 CDI (906.653, 906.655, 906.657)		06.2009	12.2010	BREMBO	2	52	28		X284087	X284088
419 CDI (906.153, 906.155, 906.253, 906.2)		03.2009		BREMBO	2	52	28		X284087	X284088
		03.2009		BOSCH	1	51	16		X275045	X275046
		03.2009		BOSCH	2	48	28		X275039	X275040
419 CDI (906.653, 906.655, 906.657)		03.2009		ATE	1	60	22		X224489	X224490
		03.2009		ATE	1	60	22		X224491	X224492
		03.2009		BOSCH	2	45	22		X274013	X274014
		03.2009		BOSCH	2	45	22		X274061	X274062
		03.2009		PERROT	2	44	22		X614009	X614010
		03.2009		PERROT	2	44	22		X615001	X615002
424 (906.153, 906.155, 906.253, 906.255)		06.2006		ATE	1	60	22		X224489	X224490
		06.2006		ATE	1	60	22		X224491	X224492
		06.2006		BOSCH	2	45	22		X274013	X274014
		06.2006		BOSCH	2	45	22		X274061	X274062
		06.2006		PERROT	2	44	22		X614009	X614010
		06.2006		PERROT	2	44	22		X615001	X615002
424 (906.953, 906.655, 906.657)		06.2006		ATE	1	60	22		X224489	X224490
		06.2006		ATE	1	60	22		X224491	X224492
		06.2006		BOSCH	2	45	22		X274013	X274014
		06.2006		BOSCH	2	45	22		X274061	X274062
		06.2006		PERROT	2	44	22		X614009	X614010
		06.2006		PERROT	2	44	22		X615001	X615002

Affectations par Marques

Vehicule application - Zuordnung nach Marke und Fahrzeuge - Applicazione per marca e veicolo - Aplicacion por marca y vehiculo



MERCEDES-BENZ

SPRINTER (906) 5-t

Tout / All / Alle / Tutti / Todos		06.2006		BREMBO	2	52	28		X284087	X284088
		06.2006		BOSCH	1	51	16		X275045	X275046
		06.2006		BOSCH	2	48	28		X275039	X275040

SPRINTER (909) 3,5-t

311 CDI (909.632, 909.633)		09.2013		BOSCH	2	45	22		X274013	X274014
		09.2013		BOSCH	2	45	22		X274061	X274062
		09.2013		PERROT	2	44	22		X614009	X614010
		09.2013		ATE	1	52	16		X225133	X225134
		09.2013		BOSCH	1	52	16		X275001	X275002
		09.2013		BOSCH	2	45	22		X275069	X275070

SPRINTER (909) 4,6-t

411 CDI (909.843)		09.2013		BOSCH	2	45	22		X274013	X274014
		09.2013		BOSCH	2	45	22		X274061	X274062
		09.2013		PERROT	2	44	22		X614009	X614010
		09.2013		ATE	1	52	16		X225133	X225134
		09.2013		BOSCH	1	52	16		X275001	X275002
		09.2013		BOSCH	2	45	22		X275069	X275070

T1 (601)

207 D 2.4		04.1977	01.1990	ATE	4	44	16		X224185	X224186
		04.1977	12.1982	PERROT	4	44	16		X614011	X614012
		04.1977	12.1982	PERROT	4	44	16		X614013	X614014
208 2.3		05.1977	12.1982	ATE	4	44	16		X224185	X224186
		05.1977	12.1982	PERROT	4	44	16		X614011	X614012
		05.1977	12.1982	PERROT	4	44	16		X614013	X614014
208 D 2.3		10.1988	02.1996	ATE	4	44	16		X224185	X224186
209 D 2.9		12.1982	01.1990	ATE	4	44	16		X224185	X224186
210 2.3		04.1977	02.1996	ATE	4	44	16		X224185	X224186
210 D 2.8		10.1988	02.1996	ATE	4	44	16		X224185	X224186
		10.1988	02.1996	ATE	4	44	16		X224187	X224188
		10.1988	02.1996	PERROT	4	44	16		X614001	X614002
		10.1988	02.1996	PERROT	4	44	16		X614003	X614004
210 D 2.9		11.1988	02.1996	ATE	4	44	16		X224185	X224186
		11.1988	02.1996	ATE	4	44	16		X224187	X224188
		11.1988	02.1996	PERROT	4	44	16		X614001	X614002
		11.1988	02.1996	PERROT	4	44	16		X614003	X614004

T1 (602)

307 D 2.4		04.1977	01.1990	ATE	4	44	16		X224185	X224186
308 D 2.3		06.1989	02.1996	ATE	4	44	16		X224185	X224186
309 D 3.0		10.1982	01.1990	ATE	4	44	16		X224185	X224186
310 2.3		01.1982	02.1996	ATE	4	44	16		X224185	X224186

Affectations par Marques

Vehicule application - Zuordnung nach Marke und Fahrzeuge - Applicazione per marca e veicolo - Aplicacion por marca y vehiculo



MERCEDES-BENZ

T1 (602)

310 D 2.9		06.1989	02.1996	ATE	4	44	16		X224185	X224186
		06.1989	02.1996	ATE	4	44	16		X224187	X224188
		06.1989	02.1996	PERROT	4	44	16		X614001	X614002
		06.1989	02.1996	PERROT	4	44	16		X614003	X614004

T1/TN

407 D (611.317, 611.318)		07.1981	01.1989	ATE	4	44	16		X224185	X224186
		07.1981	01.1989	ATE	4	44	22		X224281	X224282
407 D (611.367, 611.368)		07.1981	01.1989	ATE	4	44	16		X224185	X224186
408 D (611.317, 611.318)		11.1988	06.1995	ATE	4	44	16		X224185	X224186
		11.1988	06.1995	ATE	4	44	22		X224281	X224282
408 D (611.367, 611.368)		11.1988	06.1995	ATE	4	44	16		X224185	X224186
409 D (611.417, 611.418)		04.1982	01.1989	ATE	4	44	16		X224185	X224186
		04.1982	01.1989	ATE	4	44	22		X224281	X224282
409 D (611.467, 611.468)		04.1982	01.1989	ATE	4	44	16		X224185	X224186
410 (611.017, 611.018)		08.1982	06.1995	ATE	4	44	16		X224185	X224186
410 (611.067, 611.068)		08.1982	06.1995	ATE	4	44	16		X224185	X224186
410 D (611.417, 611.418)		11.1988	06.1995	ATE	4	44	16		X224185	X224186
410 D (611.467, 611.468)		11.1988	06.1995	ATE	4	44	16		X224185	X224186

T2/LN1

Tout / All / Alle / Tutti / Todos		04.1986	12.1994	ATE	4	44	16		X224185	X224186
-----------------------------------	--	---------	---------	-----	---	----	----	--	---------	---------

VANEO (414)

Tout / All / Alle / Tutti / Todos		02.2002		GIRL-TRW	1	57	22		X374635	X374636
		02.2002		GIRL-TRW	1	30	8		X375363	X375364

VIANO (W639)

3,0		09.2003	04.2007	BOSCH	2	48	28		X274063	X274064
		09.2003		BREMBO	2	48	28		X284131	X284132
3.2		09.2003	04.2007	BOSCH	2	48	28		X274063	X274064
		09.2003		BREMBO	2	48	28		X284131	X284132
3.5		09.2007		BREMBO	2	48	28		X284131	X284132
3.7		06.2004	04.2007	BOSCH	2	48	28		X274063	X274064
		06.2004		BREMBO	2	48	28		X284131	X284132
CDI 2.0		09.2003	04.2007	BOSCH	2	48	28		X274063	X274064
		09.2003		BREMBO	2	48	28		X284131	X284132
CDI 2.0 4-matic		07.2005	04.2007	BOSCH	2	48	28		X274063	X274064
		07.2005		BREMBO	2	48	28		X284131	X284132
CDI 2.2		09.2003	04.2007	BOSCH	2	48	28		X274063	X274064
		09.2003		BREMBO	2	48	28		X284131	X284132
CDI 2.2 4-matic		07.2005		BOSCH	2	48	28		X274063	X274064
		07.2005		BREMBO	2	48	28		X284131	X284132
CDI 3.0		03.2006	04.2007	BOSCH	2	48	28		X274063	X274064
		03.2006		BREMBO	2	48	28		X284131	X284132
Tout / All / Alle / Tutti / Todos		09.2003		BOSCH	1	38	10		X275037	X275038

X=1 : SNRA - X=2 : EAI - X=3 : SERA - X=4 : SEEAC - X=5 : NEOTO - X=6 : STARTCAR

Affectations par Marques

Vehicule application - Zuordnung nach Marke und Fahrzeuge - Applicazione per marca e veicolo - Aplicacion por marca y vehiculo



MERCEDES-BENZ

VITO (638)

Tout / All / Alle / Tutti / Todos		02.1996	07.2003	BENDIX	1	60	22		X254231	X254232
		02.1996	07.2003	BOSCH	1	33	10		X275021	X275022

VITO (W639)

109 CDI		09.2003	07.2006	BOSCH	2	48	28		X274063	X274064
		09.2006		BREMBO	2	48	28		X284131	X284132
109 CDI 4x4		09.2007	08.2014	BREMBO	2	48	28		X284131	X284132
110 CDI		09.2010	08.2014	BREMBO	2	48	28		X284131	X284132
111 CDI		09.2003	04.2007	BOSCH	2	48	28		X274063	X274064
		09.2003		BREMBO	2	48	28		X284131	X284132
111 CDI (639.701)		09.2007	08.2014	BREMBO	2	48	28		X284131	X284132
111 CDI 4x4		09.2007	08.2014	BREMBO	2	48	28		X284131	X284132
113 CDI		09.2010	08.2014	BOSCH	2	48	28		X274063	X274064
		09.2010	08.2014	BREMBO	2	48	28		X284131	X284132
113 CDI 4x4		09.2010	08.2014	BREMBO	2	48	28		X284131	X284132
115 CDI		09.2003	04.2007	BOSCH	2	48	28		X274063	X274064
		09.2003		BREMBO	2	48	28		X284131	X284132
115 CDI 4x4		09.2007	08.2014	BOSCH	2	48	28		X274063	X274064
		09.2007	08.2014	BREMBO	2	48	28		X284131	X284132
116 CDI		09.2010	08.2014	BREMBO	2	48	28		X284131	X284132
116 CDI 4x4		09.2010	08.2014	BREMBO	2	48	28		X284131	X284132
119		09.2003	04.2007	BOSCH	2	48	28		X274063	X274064
		09.2003		BREMBO	2	48	28		X284131	X284132
120 CDI		07.2006	04.2007	BOSCH	2	48	28		X274063	X274064
		07.2006		BREMBO	2	48	28		X284131	X284132
122		09.2003	09.2004	BOSCH	2	48	28		X274063	X274064
122 CDI		09.2010	08.2014	BREMBO	2	48	28		X284131	X284132
123		06.2004	04.2007	BOSCH	2	48	28		X274063	X274064
		06.2004		BREMBO	2	48	28		X284131	X284132
126		09.2007	08.2014	BREMBO	2	48	28		X284131	X284132
E-CELL		03.2012	08.2014	BOSCH	2	48	28		X274063	X274064
		03.2012	08.2014	BREMBO	2	48	28		X284131	X284132
Tout / All / Alle / Tutti / Todos		09.2003		BOSCH	1	38	10		X275037	X275038

VITO / MIXTO (W639)

109 CDI		09.2003	07.2006	BOSCH	2	48	28		X274063	X274064
		08.2006		BREMBO	2	48	28		X284131	X284132
110 CDI		09.2010	08.2014	BREMBO	2	48	28		X284131	X284132
111 CDI		09.2003	04.2007	BOSCH	2	48	28		X274063	X274064
		09.2003		BREMBO	2	48	28		X284131	X284132
111 CDI 4x4		09.2007	08.2014	BOSCH	2	48	28		X274063	X274064
		09.2007	08.2014	BREMBO	2	48	28		X284131	X284132
113 CDI		09.2010	08.2014	BOSCH	2	48	28		X274063	X274064
		09.2010	08.2014	BREMBO	2	48	28		X284131	X284132

X=1 : SNRA - X=2 : EAI - X=3 : SERA - X=4 : SEEC - X=5 : NEOTO - X=6 : STARTCAR

Affectations par Marques

Vehicule application - Zuordnung nach Marke und Fahrzeuge - Applicazione per marca e veicolo - Aplicacion por marca y vehiculo



MERCEDES-BENZ

VITO / MIXTO (W639)

113 CDI 4x4		09.2010	08.2014	BREMBO	2	48	28		X284131	X284132
115 CDI		09.2003	04.2007	BOSCH	2	48	28		X274063	X274064
		09.2003		BREMBO	2	48	28		X284131	X284132
115 CDI 4x4		07.2006		BREMBO	2	48	28		X284131	X284132
116 CDI		09.2010	08.2014	BREMBO	2	48	28		X284131	X284132
116 CDI 4x4		09.2010	08.2014	BREMBO	2	48	28		X284131	X284132
119		09.2003	04.2007	BOSCH	2	48	28		X274063	X274064
		09.2003		BREMBO	2	48	28		X284131	X284132
120 CDI		07.2006	04.2007	BOSCH	2	48	28		X274063	X274064
		07.2006		BREMBO	2	48	28		X284131	X284132
122		09.2003	09.2004	BOSCH	2	48	28		X274063	X274064
122 CDI		09.2010	08.2014	BOSCH	2	48	28		X274063	X274064
		09.2010	08.2014	BREMBO	2	48	28		X284131	X284132
123		06.2004	04.2007	BOSCH	2	48	28		X274063	X274064
		06.2004	07.2008	BREMBO	2	48	28		X284131	X284132
123 (639.603)		06.2004	04.2007	BOSCH	2	48	28		X274063	X274064
		06.2004	07.2008	BREMBO	2	48	28		X284131	X284132
126		09.2007	08.2014	BREMBO	2	48	28		X284131	X284132
E-CELL		03.2012	08.2014	BOSCH	2	48	28		X274063	X274064
		03.2012	08.2014	BREMBO	2	48	28		X284131	X284132
Tout / All / Alle / Tutti / Todos		09.2003		BOSCH	1	38	10		X275037	X275038

W114 (230-250-280)

230.6 (114.015)		01.1968	12.1976	ATE	2	57	12,7		X224057	X224058
		01.1968	12.1976	ATE	2	60	12,7		X224081	X224082
		01.1968	12.1976	BENDIX	2	57	12,7		X254029	X254030
250		07.1968	08.1972	ATE	2	57	12,7		X224057	X224058
250 (114.010)		01.1968	08.1972	ATE	2	57	12,7		X224057	X224058
250 2.8 (114.023)		06.1972	12.1976	ATE	2	57	12,7		X224057	X224058
250 C (114.021)		04.1969	06.1972	ATE	2	57	12,7		X224057	X224058
250 C 2.8 (114.023)		06.1972	12.1976	ATE	2	57	12,7		X224057	X224058
250 CE (114.022)		04.1969	04.1972	ATE	2	57	12,7		X224057	X224058
Tout / All / Alle / Tutti / Todos		06.1967	12.1970	ATE	2	38	10		X225003	X225004
		01.1970	12.1976	ATE	2	38	10		X225035	X225036
		01.1970	12.1976	BENDIX	2	38	10		X255005	X255006
		01.1970	12.1976	GIRL-TRW	2	38	10		X375007	X375008

Affectations par Marques

Vehicule application - Zuordnung nach Marke und Fahrzeuge - Applicazione per marca e veicolo - Aplicacion por marca y vehiculo



MERCEDES-BENZ

W115 (200-220-230-240)

Tout / All / Alle / Tutti / Todos		01.1968	12.1976	ATE	2	57	12,7		X224057	X224058
		01.1968	12.1976	ATE	2	60	12,7		X224081	X224082
		01.1968	12.1976	BENDIX	2	57	12,7		X254029	X254030
		01.1968	12.1970	ATE	2	38	10		X225003	X225004
		01.1970	12.1976	ATE	2	38	10		X225035	X225036
		01.1970	12.1976	BENDIX	2	38	10		X255005	X255006
		01.1970	12.1976	GIRL-TRW	2	38	10		X375007	X375008

W123 (200-220-230-240-250-300)

200		02.1976	02.1979	ATE	2	57	12,7		X224057	X224058
		02.1976	02.1979	ATE	2	60	12,7		X224123	X224124
		02.1976	02.1979	BENDIX	2	60	12,7		X254047	X254048
		06.1980	02.1985	ATE	2	60	12,7		X224149	X224150
		06.1980	02.1985	BENDIX	2	60	12,7		X254059	X254060
200 (123.020)		02.1976	07.1979	ATE	2	60	12,7		X224123	X224124
		02.1976	08.1980	ATE	2	60	12,7		X224149	X224150
		02.1976	07.1979	BENDIX	2	60	12,7		X254047	X254048
		02.1976	08.1980	BENDIX	2	60	12,7		X254059	X254060
200 (123.220)		06.1980	11.1985	ATE	2	60	12,7		X224149	X224150
		06.1980	11.1985	BENDIX	2	60	12,7		X254059	X254060
200 D		03.1979	11.1985	ATE	2	60	12,7		X224123	X224124
		03.1979	11.1985	ATE	2	60	12,7		X224149	X224150
		03.1979	11.1985	BENDIX	2	60	12,7		X254047	X254048
		03.1979	11.1985	BENDIX	2	60	12,7		X254059	X254060
220 D		01.1977	03.1979	ATE	2	60	12,7		X224123	X224124
		01.1977	03.1979	BENDIX	2	60	12,7		X254059	X254060
230 (123.023)		02.1976	03.1981	ATE	2	60	12,7		X224149	X224150
		02.1976	07.1979	ATE	2	60	12,7		X224123	X224124
		02.1976	03.1981	BENDIX	2	60	12,7		X254059	X254060
		02.1976	07.1979	BENDIX	2	60	12,7		X254047	X254048
230 E (123.223)		04.1980	02.1985	ATE	2	60	12,7		X224149	X224150
		04.1980	02.1985	BENDIX	2	60	12,7		X254059	X254060
240 D (123.123)		02.1976	07.1979	ATE	2	60	12,7		X224123	X224124
		02.1976	07.1979	BENDIX	2	60	12,7		X254047	X254048
		03.1979	11.1985	ATE	2	60	12,7		X224149	X224150
		03.1979	11.1985	BENDIX	2	60	12,7		X254059	X254060
250 (123.026)		02.1976	07.1985	ATE	2	60	12,7		X224149	X224150
		02.1976	10.1979	ATE	2	60	12,7		X224123	X224124
		02.1976	07.1985	BENDIX	2	60	12,7		X254059	X254060
		02.1976	10.1979	BENDIX	2	60	12,7		X254047	X254048
280 (123.030)		02.1976	07.1979	ATE	2	60	12,7		X224123	X224124
		02.1976	08.1981	ATE	2	60	12,7		X224149	X224150
		02.1976	07.1979	BENDIX	2	60	12,7		X254047	X254048
		02.1976	08.1981	BENDIX	2	60	12,7		X254059	X254060

X=1 : SNRA - X=2 : EAI - X=3 : SERA - X=4 : SEEC - X=5 : NEOTO - X=6 : STARTCAR

Affectations par Marques

Vehicule application - Zuordnung nach Marke und Fahrzeuge - Applicazione per marca e veicolo - Aplicacion por marca y vehiculo



MERCEDES-BENZ

W123 (200-220-230-240-250-300)

280 E		08.1976	07.1979	ATE	2	60	12,7		X224123	X224124
		08.1976	08.1981	ATE	2	60	12,7		X224149	X224150
		08.1976	07.1979	BENDIX	2	60	12,7		X254047	X254048
		08.1976	08.1981	BENDIX	2	60	12,7		X254059	X254060
280 E (123.033)		02.1976	07.1979	ATE	2	60	12,7		X224123	X224124
		02.1976	11.1985	ATE	2	60	12,7		X224149	X224150
		02.1976	07.1979	BENDIX	2	60	12,7		X254047	X254048
		02.1976	11.1985	BENDIX	2	60	12,7		X254059	X254060
300 D (123.130)		02.1976	07.1979	ATE	2	60	12,7		X224123	X224124
		02.1976	11.1985	ATE	2	60	12,7		X224149	X224150
		02.1976	07.1979	BENDIX	2	60	12,7		X254047	X254048
		02.1976	11.1985	BENDIX	2	60	12,7		X254059	X254060
300 Turbo-D (123.133)		08.1981	07.1985	ATE	2	60	12,7		X224149	X224150
		08.1981	07.1985	BENDIX	2	60	12,7		X254059	X254060
Tout / All / Alle / Tutti / Todos		01.1976	07.1979	ATE	2	38	10		X225035	X225036
		01.1976	07.1979	GIRL-TRW	2	38	10		X375007	X375008
		08.1979	12.1985	ATE	2	42	10		X225139	X225140
		08.1979	12.1985	BENDIX	2	38	10		X255005	X255006

W124 (200->500)

200		01.1986	05.1990	ATE	1	54	12		X224147	X224148
		01.1986	05.1990	GIRL-TRW	1	54	12		X374131	X374132
		01.1986	05.1990	ATE	2	35	9		X225053	X225054
		01.1986	05.1990	ATE	2	35	9		X225125	X225126
		01.1986	05.1990	BENDIX	2	35	9		X255017	X255018
200 (124.020)		12.1985	05.1990	ATE	1	54	12		X224147	X224148
		12.1985	05.1990	GIRL-TRW	1	54	12		X374131	X374132
		12.1985	05.1990	ATE	2	35	9		X225053	X225054
		12.1985	05.1990	ATE	2	35	9		X225125	X225126
		12.1985	05.1990	BENDIX	2	35	9		X255017	X255018
200 D (124.120)		12.1984	06.1993	ATE	1	54	12		X224147	X224148
		12.1984	06.1993	GIRL-TRW	1	54	12		X374131	X374132
		12.1984	06.1993	ATE	2	35	9		X225053	X225054
		12.1984	06.1993	ATE	2	35	9		X225125	X225126
		12.1984	06.1993	BENDIX	2	35	9		X255017	X255018
200 E (124.019)		10.1992	06.1993	GIRL-TRW	1	54	22		X374083	X374084
		10.1992	06.1993	ATE	2	35	9		X225053	X225054
		10.1992	06.1993	ATE	2	35	9		X225125	X225126
		10.1992	06.1993	BENDIX	2	35	9		X255017	X255018
200 E (124.021)		09.1988	08.1992	ATE	1	54	12		X224147	X224148
		09.1988	08.1992	GIRL-TRW	1	54	12		X374131	X374132
		09.1988	08.1992	ATE	2	35	9		X225053	X225054
		09.1988	08.1992	ATE	2	35	9		X225125	X225126
		09.1988	08.1992	BENDIX	2	35	9		X255017	X255018

X=1 : SNRA - X=2 : EAI - X=3 : SERA - X=4 : SEEC - X=5 : NEOTO - X=6 : STARTCAR

Affectations par Marques

Vehicule application - Zuordnung nach Marke und Fahrzeuge - Applicazione per marca e veicolo - Aplicacion por marca y vehiculo



MERCEDES-BENZ

W124 (200->500)

220 E (124.022)		10.1992	06.1993	GIRL-TRW	1	54	22		X374083	X374084
		10.1992	06.1993	ATE	2	35	9		X225053	X225054
		10.1992	06.1993	ATE	2	35	9		X225125	X225126
		10.1992	06.1993	BENDIX	2	35	9		X255017	X255018
230 E (124.023)		12.1984	06.1993	GIRL-TRW	1	54	22		X374083	X374084
		01.1985	06.1993	ATE	1	54	12		X224147	X224148
		01.1985	06.1993	GIRL-TRW	1	54	12		X374131	X374132
		12.1984	06.1993	ATE	2	35	9		X225053	X225054
		12.1984	06.1993	ATE	2	35	9		X225125	X225126
		12.1984	06.1993	ATE	2	38	9		X225059	X225060
		12.1984	06.1993	BENDIX	2	35	9		X255017	X255018
230 E (124.023) CAT		06.1989	06.1993	GIRL-TRW	1	54	22		X374083	X374084
		06.1989	06.1993	ATE	2	35	9		X225053	X225054
		06.1989	06.1993	ATE	2	35	9		X225125	X225126
		06.1989	06.1993	ATE	2	38	9		X225059	X225060
		06.1989	06.1993	BENDIX	2	35	9		X255017	X255018
250 D (124.125)		04.1985	06.1993	ATE	1	54	12		X224147	X224148
		04.1985	06.1993	GIRL-TRW	1	54	12		X374131	X374132
		04.1985	06.1993	ATE	2	35	9		X225053	X225054
		04.1985	06.1993	ATE	2	35	9		X225125	X225126
		04.1985	06.1993	ATE	2	38	9		X225059	X225060
		04.1985	06.1993	BENDIX	2	35	9		X255017	X255018
250 Turbo-D (124.128)		09.1988	06.1993	ATE	1	54	12		X224147	X224148
		09.1988	06.1993	GIRL-TRW	1	54	12		X374131	X374132
		09.1988	06.1993	ATE	2	35	9		X225053	X225054
		09.1988	06.1993	ATE	2	35	9		X225125	X225126
		09.1988	06.1993	ATE	2	38	9		X225059	X225060
		09.1988	06.1993	BENDIX	2	35	9		X255017	X255018
260 E (124.026)		09.1985	08.1992	GIRL-TRW	1	54	22		X374083	X374084
		09.1985	08.1992	ATE	2	35	9		X225053	X225054
		09.1985	08.1992	ATE	2	35	9		X225125	X225126
		09.1985	08.1992	BENDIX	2	35	9		X255017	X255018
260 E 4-matic (124.226)		09.1986	07.1989	GIRL-TRW	1	54	22		X374169	X374170
		09.1986	07.1989	ATE	2	35	9		X225053	X225054
		09.1986	07.1989	ATE	2	35	9		X225125	X225126
		09.1986	08.1992	BENDIX	2	35	9		X255017	X255018
280 E (124.028)		10.1992	06.1993	GIRL-TRW	1	54	22		X374083	X374084
		10.1992	06.1993	ATE	2	35	9		X225053	X225054
		10.1992	06.1993	ATE	2	35	9		X225125	X225126
		10.1992	06.1993	BENDIX	2	35	9		X255017	X255018
300 AMG		09.1988	06.1993	ATE	4	^{38/42}	22		X224223	X224224
		09.1988	06.1993	ATE	2	38	9		X225191	X225192

Affectations par Marques

Vehicule application - Zuordnung nach Marke und Fahrzeuge - Applicazione per marca e veicolo - Aplicacion por marca y vehiculo



MERCEDES-BENZ

W124 (200->500)

300 D (124.130)		12.1984	06.1993	ATE	1	54	12		X224147	X224148
		12.1984	06.1993	GIRL-TRW	1	54	12		X374131	X374132
		12.1984	06.1993	ATE	2	35	9		X225053	X225054
		12.1984	06.1993	ATE	2	35	9		X225125	X225126
		12.1984	08.1989	ATE	2	38	9		X225059	X225060
		12.1984	06.1993	BENDIX	2	35	9		X255017	X255018
300 D 4-matic (124.330)		09.1986	06.1993	GIRL-TRW	1	54	22		X374169	X374170
		09.1986	06.1993	ATE	2	35	9		X225053	X225054
		09.1986	06.1993	ATE	2	35	9		X225125	X225126
		09.1986	06.1993	BENDIX	2	35	9		X255017	X255018
300 E		01.1985	08.1992	GIRL-TRW	1	54	22		X374083	X374084
		01.1985	08.1992	ATE	2	35	9		X225053	X225054
		01.1985	08.1992	ATE	2	35	9		X225125	X225126
		01.1985	08.1992	ATE	2	38	9		X225059	X225060
		01.1985	08.1992	BENDIX	2	35	9		X255017	X255018
300 E (124.030)		08.1985	08.1992	GIRL-TRW	1	54	22		X374083	X374084
		08.1985	08.1992	ATE	2	35	9		X225053	X225054
		08.1985	08.1992	ATE	2	35	9		X225125	X225126
		08.1985	08.1992	ATE	2	38	9		X225059	X225060
		08.1985	08.1992	BENDIX	2	35	9		X255017	X255018
300 E 4-matic		09.1986	08.1989	GIRL-TRW	1	54	22		X374169	X374170
		09.1986	08.1989	ATE	2	35	9		X225053	X225054
		09.1986	08.1989	ATE	2	35	9		X225125	X225126
		09.1986	08.1989	ATE	2	38	9		X225059	X225060
		09.1986	02.1992	BENDIX	2	35	9		X255017	X255018
300 E 4-matic (124.230)		09.1986	06.1993	GIRL-TRW	1	54	22		X374169	X374170
		09.1986	06.1993	ATE	2	35	9		X225053	X225054
		09.1986	06.1993	ATE	2	35	9		X225125	X225126
		09.1986	06.1993	ATE	2	38	9		X225059	X225060
		09.1986	06.1993	BENDIX	2	35	9		X255017	X255018
300 E-24 (124.031)		09.1988	08.1992	ATE	4	^{38/42}	22		X224223	X224224
		09.1988	08.1992	ATE	2	35	9		X225053	X225054
		09.1988	08.1992	ATE	2	35	9		X225125	X225126
		09.1988	08.1992	ATE	2	38	9		X225059	X225060
		09.1988	08.1992	BENDIX	2	35	9		X255017	X255018
300 TD SD		06.1991	05.1993	ATE	2	57	28		X224251	X224252
		06.1991	05.1993	GIRL-TRW	4	^{40/44}	28		X374259	X374260
		06.1991	05.1993	ATE	2	40	12		X225091	X225092
300 Turbo-D (124.133)		09.1986	06.1993	GIRL-TRW	1	54	22		X374083	X374084
		09.1986	06.1993	ATE	2	35	9		X225053	X225054
		09.1986	06.1993	ATE	2	35	9		X225125	X225126
		09.1986	06.1993	ATE	2	38	9		X225059	X225060
		09.1986	06.1993	BENDIX	2	35	9		X255017	X255018

Affectations par Marques

Vehicule application - Zuordnung nach Marke und Fahrzeuge - Applicazione per marca e veicolo - Aplicacion por marca y vehiculo



MERCEDES-BENZ

W124 (200->500)

300 Turbo-D 4-matic (124.333)		09.1986	06.1993	GIRL-TRW	1	54	22		X374169	X374170
		09.1986	06.1993	ATE	2	35	9		X225053	X225054
		09.1986	06.1993	ATE	2	35	9		X225125	X225126
		09.1986	06.1993	ATE	2	38	9		X225059	X225060
		09.1986	06.1993	BENDIX	2	35	9		X255017	X255018
320 E (124.032)		10.1992	06.1993	ATE	4	42	25		X224253	X224254
		10.1992	06.1993	ATE	2	38	9		X225191	X225192
400 E		10.1992	06.1993	ATE	4	42	30	B938569->	X224255	X224256
400 E 4.2 (124.034)		10.1992	06.1993	ATE	4	42	25		X224253	X224254
420 E		07.1993	06.1993	ATE	4	42	30		X224255	X224256
500 E		01.1991	06.1993	ATE	4	42	30	B927761->	X224255	X224256
		01.1991	06.1993	BREMBO	4	42	28	->B927760	X284007	X284008
		01.1991	06.1993	ATE	2	42	22	B927761->	X225117	X225118
500 E (124.036)		01.1991	06.1993	ATE	2	57	28		X224251	X224252
		01.1991	06.1993	GIRL-TRW	4	40/44	28		X374259	X374260
		01.1991	06.1993	ATE	2	42	20		X225165	X225166

W201 (190)

2.0 (201.022)		10.1982	10.1984	ATE	1	54	11		X224163	X224164
		10.1982	10.1984	GIRL-TRW	1	54	11		X374035	X374036
2.0 (201.023)		09.1984	05.1990	ATE	1	54	11		X224163	X224164
		09.1984	05.1990	GIRL-TRW	1	54	11		X374035	X374036
2.3		09.1987	09.1988	GIRL-TRW	1	54	22		X374085	X374086
2.3 E		10.1982	09.1988	GIRL-TRW	1	54	22		X374085	X374086
2.6		10.1982	09.1988	GIRL-TRW	1	54	22		X374085	X374086
D 2.0 (201.122)		08.1983	08.1989	ATE	1	54	11		X224163	X224164
		08.1983	08.1989	GIRL-TRW	1	54	11		X374035	X374036
D 2.5 (201.126)		04.1985	08.1993	ATE	1	54	11		X224163	X224164
		04.1985	08.1993	GIRL-TRW	1	54	11		X374035	X374036
E 1.8 (201.018)		04.1990	08.1993	ATE	1	54	11		X224163	X224164
		04.1990	08.1993	GIRL-TRW	1	54	11		X374035	X374036
E 16V EVOLUTION		03.1988	08.1993	ATE	4	38/42	28	->F723281	X224273	X224274
		03.1988	08.1993	BREMBO	4	42	28	F723282->	X284007	X284008
E 2.0		10.1982	08.1993	ATE	1	54	11		X224163	X224164
		10.1982	08.1993	GIRL-TRW	1	54	11		X374035	X374036
E 2.0 (201.024)		10.1982	06.1993	ATE	1	54	11		X224163	X224164
		10.1982	06.1993	GIRL-TRW	1	54	11		X374035	X374036
E 2.3		09.1986	08.1991	GIRL-TRW	1	54	22		X374085	X374086
E 2.3 (201.028)		10.1986	08.1993	GIRL-TRW	1	54	22		X374085	X374086
E 2.3-16 (201.034)		04.1984	01.1987	GIRL-TRW	1	54	22		X374083	X374084
E 2.5-16		09.1988	04.1991	GIRL-TRW	1	54	22		X374083	X374084
E 2.6		09.1986	12.1989	GIRL-TRW	1	54	22		X374085	X374086
E 2.6 (201.029)		09.1986	08.1993	GIRL-TRW	1	54	22		X374085	X374086

X=1 : SNRA - X=2 : EAI - X=3 : SERA - X=4 : SEEAC - X=5 : NEOTO - X=6 : STARTCAR

Affectations par Marques

Vehicule application - Zuordnung nach Marke und Fahrzeuge - Applicazione per marca e veicolo - Aplicacion por marca y vehiculo



MERCEDES-BENZ

W201 (190)

Tout / All / Alle / Tutti / Todos		10.1982	08.1993	ATE	2	35	9		X225053	X225054
		10.1982	08.1993	ATE	2	35	9		X225125	X225126
		10.1982	08.1993	ATE	2	38	9		X225191	X225192
		10.1982	08.1993	BENDIX	2	35	9		X255017	X255018
		10.1982	08.1993	BENDIX	2	35	9		X255027	X255028
Turbo-D 2.5 (201.128)		02.1988	08.1993	GIRL-TRW	1	54	22		X374085	X374086

MG

EXPRESS

Tout / All / Alle / Tutti / Todos		03.2003	05.2005	GIRL-TRW	1	54	13		X374447	X374448
		03.2003	05.2005	GIRL-TRW	1	54	21		X374167	X374168
		03.2003	05.2005	GIRL-TRW	1	30	10		X375081	X375082

MG TF

Tout / All / Alle / Tutti / Todos		03.2002	12.2009	GIRL-TRW	1	48	22		X374287	X374288
		03.2002	12.2009	GIRL-TRW	1	38	10		X375231	X375232

MG ZR

Tout / All / Alle / Tutti / Todos		06.2001	04.2005	GIRL-TRW	1	54	13		X374447	X374448
		06.2001	04.2005	GIRL-TRW	1	54	21		X374167	X374168
		06.2001	04.2005	GIRL-TRW	1	30	10	#ID: 6732122_	X375081	X375082
		06.2001	04.2005	GIRL-TRW	1	34	10	#ID: 2243 2244	X375409	X375410

MG ZS

Tout / All / Alle / Tutti / Todos		06.2001	04.2005	GIRL-TRW	1	54	13		X374447	X374448
		06.2001	04.2005	GIRL-TRW	1	54	21		X374168	X374167
		06.2001	04.2005	GIRL-TRW	1	30	10	#ID: 6732122_	X375081	X375082
		06.2001	04.2005	GIRL-TRW	1	34	10	#ID: 2243 2244	X375409	X375410

MG ZT/ ZT- T

Tout / All / Alle / Tutti / Todos		06.2001	07.2005	ATE	1	57	22/Ø284		X224547	X224548
		06.2001	07.2005	ATE	1	57	25/Ø325		X224555	X224556
		06.2001	07.2005	ATE	1	36	10		X225107	X225108
		06.2001	07.2005	ATE	1	40	19		X225209	X225210

MGB GT

Tout / All / Alle / Tutti / Todos		01.1966	12.1982	LOCK	2	54	8,9		X464037	X464038
-----------------------------------	--	---------	---------	------	---	----	-----	--	---------	---------

MGC

Tout / All / Alle / Tutti / Todos		01.1967	12.1969	GIRL-TRW	2	54	12,7		X374299	X374300
-----------------------------------	--	---------	---------	----------	---	----	------	--	---------	---------

MGF (RD)

Tout / All / Alle / Tutti / Todos		03.1995	03.2002	GIRL-TRW	1	48	22		X374287	X374288
		03.1995	03.2002	GIRL-TRW	1	38	10		X375231	X375232

Affectations par Marques

Vehicule application - Zuordnung nach Marke und Fahrzeuge - Applicazione per marca e veicolo - Aplicacion por marca y vehiculo



MINI

MINI (R50, R53)

1.4		04.2003	09.2006	ATE	1	48	22		X224581	X224582
		04.2003	09.2006	GIRL-TRW	1	54	22		X374649	X374650
		04.2003	09.2006	ATE	1	34	10		X225315	X225316
Cooper		06.2001	09.2006	ATE	1	48	22		X224581	X224582
		06.2001	09.2006	ATE	1	34	10	10mm	X225315	X225316
		06.2001	04.2003	ATE	1	34	10	12mm	X225273	X225274
Cooper S		03.2002	09.2006	ATE	1	48	22		X224581	X224582
		03.2002	09.2006	ATE	1	34	10	10mm	X225315	X225316
		03.2002	04.2003	ATE	1	34	10	12mm	X225273	X225274
John Cooper Works		03.2006	09.2006	GIRL-TRW	1	54	22		X374649	X374650
		03.2006	09.2006	ATE	1	34	10		X225315	X225316
One		06.2001	09.2006	ATE	1	48	22		X224581	X224582
		06.2001	09.2006	GIRL-TRW	1	54	22		X374649	X374650
		06.2001	09.2006	ATE	1	34	10	10mm	X225315	X225316
		06.2001	04.2003	ATE	1	34	10	12mm	X225273	X225274
One D		06.2003	09.2006	ATE	1	48	22		X224581	X224582
		06.2003	09.2006	GIRL-TRW	1	54	22		X374649	X374650
		06.2003	09.2006	ATE	1	34	10		X225315	X225316
S Works		11.2003	06.2005	GIRL-TRW	1	54	22		X374649	X374650
		11.2003	06.2005	ATE	1	34	10		X225315	X225316
Works		11.2003	09.2006	GIRL-TRW	1	54	22		X374649	X374650
		11.2003	09.2006	ATE	1	34	10		X225315	X225316

MINI (R52)

Cooper		07.2004	11.2007	ATE	1	48	22		X224581	X224582
Cooper S		07.2004	11.2007	ATE	1	48	22		X224581	X224582
John Cooper Works		07.2004	11.2007	GIRL-TRW	1	54	22		X374649	X374650
One		07.2004	11.2007	ATE	1	48	22		X224581	X224582
Tout / All / Alle / Tutti / Todos		07.2004	11.2007	ATE	1	34	10		X225315	X225316

MINI (R55, R56, R57, R58, R59)

Tout / All / Alle / Tutti / Todos		10.2006		BREMBO	4	38	22		X284247	X284248
		10.2006		GIRL-TRW	1	54	22		X374707	X374708
		10.2006		GIRL-TRW	1	36	10/Ø259		X375411	X375412
		10.2006		GIRL-TRW	1	36	10/Ø280		X375489	X375490

MINI (F55, F56)

ONE / COOPER		04.2013		GIRL-TRW	1	54	22		X374779	X374780
		04.2013		MANDO	1	36	10		X485051	X485052

MINI COUNTRYMAN (R60)

Tout / All / Alle / Tutti / Todos		06.2010		GIRL-TRW	1	38	10/Ø259		X375483	X375484
-----------------------------------	--	---------	--	----------	---	----	---------	--	---------	---------

MINI PACEMAN (R61)

Tout / All / Alle / Tutti / Todos		04.2012		GIRL-TRW	1	38	10/Ø259		X375483	X375484
-----------------------------------	--	---------	--	----------	---	----	---------	--	---------	---------

Affectations par Marques

Vehicule application - Zuordnung nach Marke und Fahrzeuge - Applicazione per marca e veicolo - Aplicacion por marca y vehiculo



MITSUBISHI



3000 GT (Z1_A)

Tout / All / Alle / Tutti / Todos		06.1989	08.2000	SUMITOMO	4	40/43			X644101	X644102
		06.1989	08.2000	SUMITOMO	2	38			X645005	X645006

ASX (GA_W_, XA ,XB)

Tout / All / Alle / Tutti / Todos		02.2010		AKE	1	57	26		X164317	X164318
		02.2010		AKE	1	35	10		X165197	X165198
		02.2010		AKE	1	41	10		X165205	X165206

CARISMA (DA_)

1.3 (DA6A)		09.2000	10.2004	GIRL-TRW	1	54	24/Ø256		X374401	X374402
		09.2000	10.2004	GIRL-TRW	1	54	24/Ø281		X374419	X374420
1.6 (DA1A)		07.1995	02.1999	GIRL-TRW	1	54	18		X374399	X374400
		07.1995	06.2006	GIRL-TRW	1	54	24/Ø256		X374401	X374402
		07.1995	06.2006	GIRL-TRW	1	54	24/Ø281		X374419	X374420
1.8 (DA2A)		07.1995	06.2006	GIRL-TRW	1	54	24/Ø256		X374401	X374402
		07.1995	06.2006	GIRL-TRW	1	54	24/Ø281		X374419	X374420
1.8 16V (DA2A)		07.1995	06.2006	GIRL-TRW	1	54	24/Ø256		X374401	X374402
		07.1995	06.2006	GIRL-TRW	1	54	24/Ø281		X374419	X374420
1.8 16V GDI (DA2A)		09.1997	10.2004	GIRL-TRW	1	54	24/Ø256		X374401	X374402
		09.1997	10.2004	GIRL-TRW	1	54	24/Ø281		X374419	X374420
1.8 GDI (DA2A)		10.2000	10.2004	GIRL-TRW	1	54	24/Ø256		X374401	X374402
		10.2000	10.2004	GIRL-TRW	1	54	24/Ø281		X374419	X374420
1.9 DI-D		09.2000	10.2004	GIRL-TRW	1	54	24/Ø256		X374401	X374402
		09.2000	10.2004	GIRL-TRW	1	54	24/Ø281		X374419	X374420
1.9 DI-D (DA5A)		09.2000	10.2004	GIRL-TRW	1	54	18		X374399	X374400
		09.2000	10.2004	GIRL-TRW	1	54	24/Ø256		X374401	X374402
		09.2000	10.2004	GIRL-TRW	1	54	24/Ø281		X374419	X374420
1.9 TD (DA4A)		10.1996	02.1999	GIRL-TRW	1	54	18		X374399	X374400
		10.1996	09.2000	GIRL-TRW	1	54	24/Ø256		X374401	X374402
		10.1996	09.2000	GIRL-TRW	1	54	24/Ø281		X374419	X374420
Tout / All / Alle / Tutti / Todos		07.1995	08.2000	AKE	1	35	10		X165119	X165120
		09.2000	06.2006	GIRL-TRW	1	38	10		X375233	X375234

CELESTE (A7_)

Tout / All / Alle / Tutti / Todos		10.1975	12.1979	SUMITOMO	1	51	13		X644029	X644030
-----------------------------------	--	---------	---------	----------	---	----	----	--	---------	---------

COLT CZC (RG)

1.5		05.2006	07.2008	GIRL-TRW	1	54	24/Ø255		X374681	X374682
1.5 Turbo		05.2006	07.2008	GIRL-TRW	1	54	24/Ø281		X374419	X374420
Tout / All / Alle / Tutti / Todos		05.2006	07.2008	GIRL-TRW	1	34	10		X375369	X375370

COLT I (A15_A)

Tout / All / Alle / Tutti / Todos		12.1978	12.1984	SUMITOMO	1	51	19		X644035	X644036
-----------------------------------	--	---------	---------	----------	---	----	----	--	---------	---------

COLT II (C1_A)

Tout / All / Alle / Tutti / Todos		06.1986	12.1993	SUMITOMO	1	54	18		X644099	X644100
-----------------------------------	--	---------	---------	----------	---	----	----	--	---------	---------

X=1 : SNRA - X=2 : EAI - X=3 : SERA - X=4 : SEEAC - X=5 : NEOTO - X=6 : STARTCAR

Affectations par Marques

Vehicule application - Zuordnung nach Marke und Fahrzeuge - Applicazione per marca e veicolo - Aplicacion por marca y vehiculo



MITSUBISHI



COLT III (C5_A)

1.3 (C51A)		04.1988	06.1990	AKE	1	54	18		X164097	X164098
1.3 12V (C51A)		04.1988	05.1992	SUMITOMO	1	51	13		X644103	X644104
		04.1988	05.1992	SUMITOMO	1	54	18		X644099	X644100
1.3 GL (C61A)		04.1988	12.1990	AKE	1	54	18		X164097	X164098
		04.1988	12.1990	SUMITOMO	1	54	18		X644099	X644100
1.5 (C52A) CAT		07.1990	05.1992	SUMITOMO	1	51	13		X644103	X644104
		07.1990	05.1992	SUMITOMO	1	54	18		X644099	X644100
1.5 GLXi (C52A)		04.1988	06.1990	SUMITOMO	1	51	13		X644003	X644004
1.6 GTi 16V (C53A)		04.1988	05.1990	AKE	1	54	24		X164103	X164104
		04.1988	05.1990	AKE	1	30	10	ABS	X165063	X165064
		04.1988	05.1990	AKE	1	35	10	ABS	X165053	X165054
1.8 Diesel GLX (C54A)		04.1988	05.1990	AKE	1	54	18		X164097	X164098
		04.1988	05.1992	SUMITOMO	1	54	18		X644099	X644100
1.8 GTi 16V (C58A) CAT		06.1990	11.1991	AKE	1	54	24		X164201	X164202
		06.1990	11.1991	AKE	1	30	10	ABS	X165063	X165064
		06.1990	11.1991	AKE	1	35	10	ABS	X165053	X165054

COLT IV (CA_A)

1.3 GLi 12V (CA1A)		04.1992	08.1995	SUMITOMO	1	51	13		X644105	X644106
		04.1992	08.1995	SUMITOMO	1	54	18		X644107	X644108
1.6 (CA4A)		02.1994	04.1996	SUMITOMO	1	54	18		X644107	X644108
1.6 4WD (CC4A)		08.1993	08.1995	SUMITOMO	1	54	18		X644107	X644108
1.6 GLXi 16V (CA4A)		04.1992	04.1996	SUMITOMO	1	54	18		X644107	X644108
1.8 GTi 16V (CA5A)		04.1992	08.1995	AKE	1	54	24		X164215	X164216
Tout / All / Alle / Tutti / Todos		04.1992	04.1996	AKE	1	30	10		X165081	X165082

COLT V (CJ_, CP_)

Tout / All / Alle / Tutti / Todos		11.1995	09.2003	SUMITOMO	1	54	18		X644107	X644108
-----------------------------------	--	---------	---------	----------	---	----	----	--	---------	---------

COLT VI (Z3_A, Z2_A)

1.1		10.2004	06.2012	GIRL-TRW	1	54	24		X374681	X374682
1.1 Bifuel		10.2004	06.2012	GIRL-TRW	1	54	24		X374681	X374682
1.3		06.2004	06.2012	GIRL-TRW	1	54	24		X374681	X374682
1.3 Bifuel		06.2004	06.2012	GIRL-TRW	1	54	24		X374681	X374682
1.5		06.2004	06.2012	GIRL-TRW	1	54	24/Ø255		X374681	X374682
1.5 CZT		03.2005	06.2012	GIRL-TRW	1	54	24/Ø281		X374419	X374420
1.5 DI-D		08.2004	06.2012	GIRL-TRW	1	54	24/Ø255		X374681	X374682
Tout / All / Alle / Tutti / Todos		06.2004	06.2012	GIRL-TRW	1	34	10		X375369	X375370

DELICA / SPACE GEAR

Tout / All / Alle / Tutti / Todos		05.1995	01.2007	AKE	1	60	24		X164239	X164240
		05.1995	01.2007	AKE	2	43	24		X164227	X164228

ECLIPSE I (D2_A)

1.8 (D21A)		12.1989	03.1994	AKE	1	54	24		X164201	X164202
		12.1989	01.1991	AKE	1	30	10		X165065	X165066

X=1 : SNRA - X=2 : EAI - X=3 : SERA - X=4 : SEEC - X=5 : NEOTO - X=6 : STARTCAR

Affectations par Marques

Vehicule application - Zuordnung nach Marke und Fahrzeuge - Applicazione per marca e veicolo - Aplicacion por marca y vehiculo



MITSUBISHI



ECLIPSE I (D2_A)

2.0		12.1989	12.1992	AKE	1	54	24		X164201	X164202
2.0 i 16V (D22A, D27A)		04.1991	08.1994	AKE	1	54	24	#ID:AD5424142182	X164201	X164202
		04.1991	08.1994	AKE	1	60	24	#ID:AD6024142323	X164209	X164210
2.0 i 16V 4WD (D22A, D27A)		04.1991	08.1994	AKE	2	42	24		X164213	X164214
		04.1991	08.1994	AKE	1	35	10		X165089	X165090
2.0 Turbo		12.1989	03.1994	AKE	1	54	24		X164201	X164202

ECLIPSE II (D3_A)

2000 16V (GS/GT)		12.1995	04.1999	AKE	1	60	24		X164217	X164218
		12.1995	04.1999	AKE	1	35	10		X165051	X165052
2400 16V (GS)		09.1998	04.1999	AKE	1	60	24		X164217	X164218
		09.1998	04.1999	AKE	1	35	10		X165051	X165052

ECLIPSE III (D5_A)

3.0		05.1999	03.2005	AKE	1	35	10		X165051	X165052
-----	--	---------	---------	-----	---	----	----	--	---------	---------

FTO (DE_A) COUPE

Tout / All / Alle / Tutti / Todos		09.1994	07.2001	AKE	1	60	24		X164217	X164218
		09.1994	07.2001	AKE	1	35	10		X165051	X165052

GALANT I (A12_)

Tout / All / Alle / Tutti / Todos		01.1977	08.1980	SUMITOMO	1	51	13		X644029	X644030
		01.1977	08.1980	AKE	1	35	10		X165013	X165014

GALANT II (A16_)

Tout / All / Alle / Tutti / Todos		09.1980	05.1984	AKE	1	51	12,5		X164039	X164040
		09.1980	05.1984	SUMITOMO	1	51	13		X644009	X644010
		09.1980	05.1984	SUMITOMO	1	57	12,5		X644051	X644052
		09.1980	05.1984	AKE	1	38	10		X165037	X165038

GALANT III (E1_A)

1.6 GLX (E11A)		06.1984	12.1987	AKE	1	54	18		X164097	X164098
1.8, 2.0, 2.4		06.1984	12.1987	AKE	1	54	24		X164103	X164104
Tout / All / Alle / Tutti / Todos		06.1984	12.1987	AKE	1	30	10		X165047	X165048

GALANT IV (E3_A)

1.6 (E31A)		01.1988	12.1989	AKE	1	54	18		X164097	X164098
1.8 (E32A)		11.1987	05.1990	AKE	1	54	24		X164103	X164104
		06.1990	10.1992	AKE	1	54	24	ABS	X164201	X164202
		06.1990	10.1992	AKE	1	60	24	ABS	X164209	X164210
		11.1987	10.1992	AKE	1	35	10		X165085	X165086
1.8 D		01.1988	05.1990	AKE	1	54	24		X164103	X164104
		01.1988	10.1992	AKE	1	54	24		X164201	X164202
1.8 Turbo-D (E34A)		12.1987	05.1990	AKE	1	54	24		X164103	X164104
		06.1990	10.1992	AKE	1	54	24		X164201	X164202
2.0 (E33A, E39A, E38A)		04.1989	05.1990	AKE	1	54	24		X164103	X164104
		06.1990	10.1992	AKE	1	54	24	ABS	X164201	X164202
		06.1990	10.1992	AKE	1	60	24	ABS	X164209	X164210

X=1 : SNRA - X=2 : EAI - X=3 : SERA - X=4 : SEEC - X=5 : NEOTO - X=6 : STARTCAR

Affectations par Marques

Vehicule application - Zuordnung nach Marke und Fahrzeuge - Applicazione per marca e veicolo - Aplicacion por marca y vehiculo



MITSUBISHI



GALANT IV (E3_A)

2.0 (E39A, E38A, E33A)		11.1987	05.1990	AKE	1	30	10	ABS	X165065	X165066
		10.1989	10.1992	AKE	1	35	10	ABS	X165085	X165086
2.0 4WD (E33A, E38A, E39A)		06.1988	05.1990	AKE	1	54	24		X164103	X164104
		06.1990	10.1992	AKE	1	60	24		X164209	X164210
		12.1988	10.1992	AKE	1	35	10		X165089	X165090
2.0 GTi 16V (E39A, E38A, E33A)		11.1987	05.1990	AKE	1	54	24		X164103	X164104
		11.1987	10.1992	AKE	1	60	24		X164209	X164210
		11.1988	10.1992	AKE	2	42	24		X164213	X164214
		11.1987	05.1990	AKE	1	30	10	ABS	X165065	X165066
		11.1987	10.1992	AKE	1	35	10	ABS	X165085	X165086
2.0 GTi 16V 4WD (E38A, E39A, E33A) CA		06.1988	10.1992	AKE	2	42	24		X164213	X164214
2.0 GTi 16V 4WD (E39A, E38A, E33A)		06.1988	10.1992	AKE	1	35	10		X165089	X165090
2.0 GTi 16V 4x4 (E38A, E39A, E33A)		07.1989	05.1990	AKE	1	54	24		X164103	X164104
		07.1989	12.1992	AKE	2	42	24		X164213	X164214
		06.1990	12.1992	AKE	1	60	24		X164209	X164210
		07.1989	12.1992	AKE	1	35	10		X165089	X165090

GALANT V (E5_A, E7_A, E8_A)

1.8 (E52A)		02.1994	08.1996	AKE	1	54	24	ABS	X164215	X164216
		02.1994	08.1996	AKE	1	60	24	ABS	X164217	X164218
		02.1994	08.1996	AKE	1	35	10		X165051	X165052
1.8 GLSI (E52A)		11.1992	08.1996	AKE	1	54	24	ABS	X164215	X164216
		11.1992	08.1996	AKE	1	60	24	ABS	X164217	X164218
		11.1992	08.1996	AKE	1	35	10		X165051	X165052
2.0 GLSI (E55A)		11.1992	08.1996	AKE	1	60	24	ABS	X164217	X164218
		11.1992	08.1996	AKE	1	35	10		X165051	X165052
2.0 GLSI 4WD (E75A)		11.1992	08.1996	AKE	1	60	24	ABS	X164217	X164218
2.0 GLSTD (E57A)		11.1992	08.1996	AKE	1	54	24	ABS	X164215	X164216
		11.1992	08.1996	AKE	1	60	24	ABS	X164217	X164218
		11.1992	08.1996	AKE	1	35	10		X165051	X165052
2.0 V6-24 (E64A, E54A)		11.1992	08.1996	AKE	1	60	24	ABS	X164217	X164218
		11.1992	08.1996	AKE	1	35	10		X165051	X165052
2.5 V6-24 4WD (E88A)		11.1992	08.1996	AKE	2	43	24		X164207	X164208
		11.1992	08.1996	AKE	1	38	10		X165091	X165092

GALANT VI (EA_)

2.0 (EA2A)		09.1996	09.2000	AKE	1	60	24/Ø256		X164217	X164218
		09.1996	10.2004	AKE	1	60	24/Ø276		X164287	X164288
		09.1996	09.2000	AKE	2	43	24		X164207	X164208
2.0 (EA2W)		09.1996	09.2000	AKE	1	60	24/Ø256		X164217	X164218
		09.1996	10.2003	AKE	1	60	24/Ø276		X164287	X164288
		09.1996	09.2000	AKE	2	43	24		X164207	X164208
2.0 TDI (EA6A)		09.1996	07.2001	AKE	1	60	24/Ø256		X164217	X164218
2.0 TDI (EA6W)		09.1996	07.2001	AKE	1	60	24/Ø256		X164217	X164218

X=1 : SNRA - X=2 : EAI - X=3 : SERA - X=4 : SEEAC - X=5 : NEOTO - X=6 : STARTCAR

Affectations par Marques

Vehicule application - Zuordnung nach Marke und Fahrzeuge - Applicazione per marca e veicolo - Aplicacion por marca y vehiculo



MITSUBISHI



GALANT VI (EA_)

2.4 GDI (EA3A)		02.1999	10.2004	AKE	1	60	24/Ø276		X164287	X164288
		02.1999	02.2000	AKE	2	43	24		X164207	X164208
2.4 GDI (EA3W)		02.1999	10.2003	AKE	1	60	24/Ø276		X164287	X164288
		02.1999	02.2000	AKE	2	43	24		X164207	X164208
2.5 Type S		10.1999	10.2004	AKE	1	60	24/Ø276		X164287	X164288
		10.1999	02.2000	AKE	2	43	24		X164207	X164208
2.5 V6 24V (EA5A)		09.1996	11.1997	AKE	1	60	24/Ø256		X164217	X164218
		09.1996	10.2004	AKE	1	60	24/Ø276		X164287	X164288
		09.1996	09.2000	AKE	2	43	24		X164207	X164208
2.5 V6 24V (EA5W)		09.1996	11.1997	AKE	1	60	24/Ø256		X164217	X164218
		09.1996	10.2003	AKE	1	60	24/Ø276		X164287	X164288
		09.1996	09.2000	AKE	2	43	24		X164207	X164208
Tout / All / Alle / Tutti / Todos		09.1996	10.2004	AKE	1	35	10		X165051	X165052

GALLOPER (JK-01)

Tout / All / Alle / Tutti / Todos		09.1998	12.2003	AKE	2	43	24		X164227	X164228
		09.1998	12.2003	MANDO	1	57	24		X484017	X484018
		09.1998	12.2003	SUMITOMO	1	43	18		X645019	X645020

GRANDIS (NA_W)

Tout / All / Alle / Tutti / Todos		04.2004	12.2011	SUMITOMO	2	45	26		X644177	X644178
		04.2004	12.2011	AKE	1	38	12		X165167	X165168

GTO (Z1_A)

Tout / All / Alle / Tutti / Todos		06.1992	08.2000	SUMITOMO	2	38			X645005	X645006
-----------------------------------	--	---------	---------	----------	---	----	--	--	---------	---------

i (HA_)

Tout / All / Alle / Tutti / Todos		07.2009		TOKICO	1	51	17		X674071	X674072
-----------------------------------	--	---------	--	--------	---	----	----	--	---------	---------

L 200 (K3_T, K2_T, K1_T, K0_T)

Tout / All / Alle / Tutti / Todos		11.1986	10.1996	AKE	1	57	22/Ø258	#ID: 2211	X164129	X164130
		11.1986	10.1996	AKE	1	57	22/Ø277	#ID: 2212	X164127	X164128

L 200 (K7_T, K6_T)

2.0 (K62T)		06.1996	12.2007	AKE	1	60	24/Ø276		X164239	X164240
2.4 4WD (K75T)		06.1996	12.2007	AKE	1	60	24/Ø276		X164239	X164240
		06.1996	12.2007	AKE	2	43	24/Ø276		X164227	X164228
		06.1996	12.2007	TOKICO	1	60	24		X674083	X674084
		06.1996	12.2007	TOKICO	1	60	24		X674083	X674084
2.5 D (K64T)		06.1996	12.2007	AKE	1	60	24		X164261	X164262
		06.1996	12.2007	AKE	1	60	24/Ø276		X164239	X164240
		06.1996	12.2007	AKE	2	43	24		X164237	X164238
		06.1996	12.2007	AKE	2	43	24		X164325	X164326
2.5 TD (K64T)		08.2001	07.2003	AKE	2	43	24		X164237	X164238
		08.2001	07.2003	AKE	2	43	24		X164325	X164326

Affectations par Marques

Vehicule application - Zuordnung nach Marke und Fahrzeuge - Applicazione per marca e veicolo - Aplicacion por marca y vehiculo



MITSUBISHI



L 200 (K7_T, K6_T)

2.5 TD 4WD (K74T)		06.1996	12.2007	AKE	1	60	24		X164239	X164240
		06.1996	12.2007	AKE	2	43	24		X164227	X164228
		06.1996	12.2007	AKE	2	43	24		X164325	X164326
		06.1996	12.2007	TOKICO	1	60	24		X674083	X674084
		06.1996	12.2007	TOKICO	2	43	24		X674077	X674078

L 200 (KA_T, RWD)

Tout / All / Alle / Tutti / Todos		11.2005	12.2015	TOKICO	1	60	28		X674089	X674090
-----------------------------------	--	---------	---------	--------	---	----	----	--	---------	---------

L 200 (KB_T)

Tout / All / Alle / Tutti / Todos		11.2005	12.2015	TOKICO	1	60	24		X674083	X674084
		11.2005	12.2015	TOKICO	1	60	28		X674089	X674090

L 300 (L03_P)

Tout / All / Alle / Tutti / Todos		04.1983	10.1986	AKE	1	54	20		X164177	X164178
		04.1983	10.1986	SUMITOMO	1	54	20		X644093	X644094

L 300 (P0_W, P1_W, P2_W)

Tout / All / Alle / Tutti / Todos		11.1986	06.2007	AKE	1	57	22/Ø258	#ID: 2211	X164129	X164130
		11.1986	06.2007	AKE	1	57	22/Ø277	#ID: 2212	X164127	X164128

L 300 (P1_T)

Tout / All / Alle / Tutti / Todos		07.1994	04.2000	AKE	2	43	24		X164237	X164238
-----------------------------------	--	---------	---------	-----	---	----	----	--	---------	---------

L 400 (PD_W, PC_W, PB_V, PA_W, PA_V)

2.0		05.1995	03.2001	AKE	1	60	24/Ø276		X164239	X164240
		05.1995	03.2001	AKE	2	43	24/Ø254		X164237	X164238
2500 TD (PD5W, PD5V, PA5W, PA5V)		05.1995	03.2003	AKE	1	60	24/Ø276		X164239	X164240
		05.1995	03.2003	AKE	2	43	24/Ø254		X164237	X164238
2500 TD 4WD (PD5W, PD5V, PA5W, PA5)		05.1995	03.2001	AKE	2	43	24/Ø276		X164227	X164228
Tout / All / Alle / Tutti / Todos		05.1995	03.2003	AKE	1	38	18		X165123	X165124

LANCER I (A7_)

Tout / All / Alle / Tutti / Todos		02.1973	12.1979	SUMITOMO	1	51	13		X644029	X644030
-----------------------------------	--	---------	---------	----------	---	----	----	--	---------	---------

LANCER II (A17_)

Tout / All / Alle / Tutti / Todos		01.1979	12.1984	SUMITOMO	1	51	13		X644009	X644010
		01.1979	12.1984	SUMITOMO	1	57	13		X644051	X644052
		01.1979	12.1984	AKE	1	38	10	A174	X165037	X165038
		01.1979	12.1984	AKE	1	38		A171, A172	X165009	X165010
		01.1979	12.1984	AKE	1	41	10	A176	X165033	X165034

LANCER III (C1_V, C3_V)

1.5 (C12V)		09.1985	04.1988	AKE	1	54	18		X164097	X164098
		09.1985	04.1988	SUMITOMO	1	51	13/Ø243		X644003	X644004
		09.1988	12.1990	SUMITOMO	1	54	18		X644099	X644100
1.5 12V (C12V)		09.1990	12.1991	SUMITOMO	1	51	13/Ø234		X644103	X644104
		09.1990	12.1991	SUMITOMO	1	54	18		X644099	X644100

Affectations par Marques

Vehicule application - Zuordnung nach Marke und Fahrzeuge - Applicazione per marca e veicolo - Aplicacion por marca y vehiculo



MITSUBISHI



LANCER III (C1_V, C3_V)

1.8 4WD (C37V)		01.1987	05.1990	AKE	1	54	18		X164097	X164098
		01.1987	06.1992	SUMITOMO	1	54	18		X644099	X644100
1.8 D (C14V)		09.1985	05.1990	AKE	1	54	18		X164097	X164098
		08.1986	06.1992	SUMITOMO	1	54	18		X644099	X644100

LANCER IV (C6_A, C7_A)

1.3 12V (C61A)		06.1992	05.1994	SUMITOMO	1	51	13/Ø234		X644103	X644104
		06.1992	05.1994	SUMITOMO	1	54	18		X644099	X644100
1.3 GL		05.1988	06.1990	AKE	1	54	18		X164097	X164098
		05.1988	06.1990	SUMITOMO	1	51	13/Ø234		X644103	X644104
		05.1988	06.1990	SUMITOMO	1	51	13/Ø243		X644003	X644004
1.5 (C62A)		06.1988	06.1990	AKE	1	54	18		X164097	X164098
		06.1988	06.1990	SUMITOMO	1	51	13/Ø243		X644003	X644004
1.5 12V (C62A)		05.1989	05.1992	SUMITOMO	1	51	13/Ø234		X644103	X644104
		05.1989	05.1992	SUMITOMO	1	54	18		X644099	X644100
1.6 16V (C76A, C66A)		06.1992	05.1994	AKE	1	54	24		X164201	X164202
		06.1992	05.1994	SUMITOMO	1	54	18		X644099	X644100
		06.1992	05.1994	AKE	1	35	10		X165053	X165054
1.8 4WD (C77A)		09.1989	05.1990	AKE	1	54	18		X164097	X164098
		09.1989	06.1992	SUMITOMO	1	54	18		X644099	X644100
1.8 D (C64A)		04.1988	05.1990	AKE	1	54	18		X164097	X164098
		04.1988	05.1992	SUMITOMO	1	54	18		X644099	X644100
1.8 GLX Diesel (C64A)		04.1988	05.1990	AKE	1	54	18		X164097	X164098
		04.1988	05.1992	SUMITOMO	1	54	18		X644099	X644100
1.8 GTi 16V (C68A)		11.1989	05.1992	AKE	1	54	24		X164201	X164202
		11.1989	05.1992	AKE	1	30	10	ABS	X165063	X165064
		11.1989	05.1992	AKE	1	35	10	ABS	X165053	X165054
1.8 GTi 16V (C69A)		06.1992	12.1993	AKE	1	54	24		X164215	X164216
		06.1992	12.1993	AKE	1	30	10		X165081	X165082
2.0 D (C67A)		06.1992	07.1993	SUMITOMO	1	54	18		X644099	X644100

LANCER V (CB_A, CD_A)

1.3		06.1992	02.1995	SUMITOMO	1	51	13		X644105	X644106
		06.1992	02.1995	SUMITOMO	1	54	18		X644107	X644108
1.3 (CB1A)		06.1992	02.1995	SUMITOMO	1	51	13		X644105	X644106
		06.1992	02.1995	SUMITOMO	1	54	18		X644107	X644108
1.6 (CB4A)		02.1994	08.1995	SUMITOMO	1	54	18		X644107	X644108
1.6 16V (CB4A)		06.1992	08.1995	SUMITOMO	1	54	18		X644107	X644108
1.6 16V 4WD (CD4A)		06.1992	11.1993	SUMITOMO	1	54	18		X644107	X644108
1.8 16V (CB5A)		06.1992	12.1993	AKE	1	54	24		X164215	X164216
2.0 Diesel (CB8A)		06.1992	12.1996	SUMITOMO	1	54	18		X644107	X644108
Tout / All / Alle / Tutti / Todos		06.1992	12.1996	AKE	1	30	10		X165081	X165082

X=1 : SNRA - X=2 : EAI - X=3 : SERA - X=4 : SEEAC - X=5 : NEOTO - X=6 : STARTCAR

Affectations par Marques

Vehicule application - Zuordnung nach Marke und Fahrzeuge - Applicazione per marca e veicolo - Aplicacion por marca y vehiculo



MITSUBISHI



LANCER V (CB_W, CD_W)

Tout / All / Alle / Tutti / Todos		12.1992	10.2003	SUMITOMO	1	54	18		X644107	X644108
		12.1992	10.2003	AKE	1	35	10		X165117	X165118

LANCER VI (CJ_, CP_)

Tout / All / Alle / Tutti / Todos		12.1995	08.2003	SUMITOMO	1	54	18		X644107	X644108
-----------------------------------	--	---------	---------	----------	---	----	----	--	---------	---------

LANCER VII (CS, CG, CH, CJ, CT)

Tout / All / Alle / Tutti / Todos		09.2003	12.2007	AKE	1	60	24		X164287	X164288
		09.2003	12.2007	AKE	1	38	10		X165169	X165170

LANCER VII (CS_W)

Tout / All / Alle / Tutti / Todos		09.2003		AKE	1	60	24		X164287	X164288
		09.2003		AKE	1	38	10		X165169	X165170

LANCER VII EVO

Tout / All / Alle / Tutti / Todos		03.2005	12.2007	BREMBO	2	40			X285105	X285106
-----------------------------------	--	---------	---------	--------	---	----	--	--	---------	---------

LANCER VIII (CX_A)

1.5		06.2008	06.2010	AKE	1	57	26		X164317	X164318
		06.2008	06.2010	AKE	1	35	10/Ø262		X165193	X165194
1.5 Bifuel		03.2010		AKE	1	57	26		X164317	X164318
		03.2010		AKE	1	35	10/Ø262		X165193	X165194
1.6		05.2010		AKE	1	57	26		X164317	X164318
		05.2010		AKE	1	35	10/Ø262		X165193	X165194
1.8		03.2009		AKE	1	57	26		X164317	X164318
		03.2009		AKE	1	35	10/Ø262		X165193	X165194
1.8 (CX3A)		06.2008	09.2011	AKE	1	57	26		X164317	X164318
		06.2008	09.2011	AKE	1	35	10/Ø262		X165193	X165194
1.8 Bifuel		02.2010		AKE	1	57	26		X164317	X164318
		02.2010		AKE	1	35	10/Ø262		X165193	X165194
1.8 DI-D		05.2010		AKE	1	57	26		X164317	X164318
		05.2010		AKE	1	35	10/Ø262		X165193	X165194
1.8 DI-D (CX9A)		06.2010		AKE	1	57	26		X164317	X164318
		06.2010		AKE	1	35	10/Ø262		X165193	X165194
1.8 Flex		03.2009		AKE	1	57	26		X164317	X164318
		03.2009		AKE	1	35	10/Ø262		X165193	X165194
2.0 DI-D		06.2008		AKE	1	57	26		X164317	X164318
		06.2008		AKE	1	35	10/Ø262		X165193	X165194
2.0 Ralliart (CX4A)		10.2008		AKE	2	43	24		X164207	X164208
		10.2008		AKE	1	38	12		X165167	X165168

LANCER VIII (CY_A, CZ_A)

Tout / All / Alle / Tutti / Todos		01.2008		AKE	1	57	26		X164317	X164318
		01.2008		AKE	1	35	10/Ø262		X165193	X165194

MIRAGE

1.3		12.1991	08.1995	SUMITOMO	1	51	13		X644105	X644106
		12.1991	08.1995	SUMITOMO	1	54	18		X644107	X644108

X=1 : SNRA - X=2 : EAI - X=3 : SERA - X=4 : SEEAC - X=5 : NEOTO - X=6 : STARTCAR

Affectations par Marques

Vehicule application - Zuordnung nach Marke und Fahrzeuge - Applicazione per marca e veicolo - Aplicacion por marca y vehiculo



MITSUBISHI



MIRAGE

1.6		12.1991	07.2003	SUMITOMO	1	54	18		X644107	X644108
1.6 4WD		12.1991	08.1995	SUMITOMO	1	54	18		X644107	X644108
Tout / All / Alle / Tutti / Todos		12.1991	07.2003	AKE	1	30	10		X165081	X165082

OUTLANDER I (CU_W)

Tout / All / Alle / Tutti / Todos		05.2003	10.2006	AKE	2	43	24		X164207	X164208
		05.2003	10.2006	AKE	1	38	10		X165169	X165170

OUTLANDER II (CW_W)

Tout / All / Alle / Tutti / Todos		11.2006	11.2012	AKE	1	57	26		X164317	X164318
		11.2006	11.2012	AKE	2	43	24		X164207	X164208
		11.2006	11.2012	AKE	1	35	10	#ID: 3503	X165197	X165198
		11.2006	11.2012	AKE	1	38	12	#ID: 3806	X165167	X165168

OUTLANDER III (GG_W, GF_W, ZJ)

Tout / All / Alle / Tutti / Todos		04.2013		AKE	2	43	24		X164207	X164208
		04.2013		AKE	1	41	10		X165205	X165206

PAJERO CLASSIC (V2_W)

Tout / All / Alle / Tutti / Todos		07.2002		AKE	2	43	24		X164227	X164228
		07.2002		AKE	1	43	18		X165057	X165058

PAJERO I (L04_G, L14_G)

2.3 TD (L043G, L048G)		12.1982	04.1986	AKE	1	54	20		X164107	X164108
2.5 TD (L044G, L049G)		05.1986	11.1990	AKE	1	54	20	#ID: 2113	X164107	X164108
		05.1986	11.1990	AKE	1	57	22	#ID: 2211	X164129	X164130
		05.1986	11.1990	AKE	1	57	22	#ID: 2212	X164127	X164128
2.6 (L042G, L047G)		01.1983	11.1990	AKE	1	54	20	#ID: 2113	X164107	X164108
		01.1983	11.1990	AKE	1	57	22	#ID: 2211	X164129	X164130
		01.1983	11.1990	AKE	1	57	22	#ID: 2212	X164127	X164128
3.0 V6 (L141G, L146G)		11.1988	11.1990	AKE	1	57	22		X164127	X164128

PAJERO II (V3_W, V2_W, V4_W)

2.4 (V21)		04.1991	10.1999	AKE	2	43	24		X164227	X164228
2.5 D (V14)		01.1992	10.1999	AKE	1	60	22		X164225	X164226
2.5 D, 2.5 TD (V34)		01.1992	10.1999	AKE	1	60	22		X164225	X164226
		01.1992	10.1999	AKE	2	43	24		X164227	X164228
2.5 TD (V24, V44)		12.1990	10.1999	AKE	2	43	24		X164227	X164228
2.5 TD 4WD (V24)		12.1990	10.1999	AKE	1	60	22		X164225	X164226
		12.1990	10.1999	AKE	2	43	24		X164227	X164228
2.6 (V12, V32)		03.1991	10.1997	AKE	1	60	22		X164225	X164226
2.8 D (V26, V36, V46)		11.1993	07.1997	AKE	2	43	24		X164227	X164228
2.8 TD (V46)		06.1994	10.1999	AKE	2	43	24		X164227	X164228
3.0 V6 24V (V23, V43)		12.1990	10.1999	AKE	2	43	24		X164227	X164228
3.5 V6 24V (V25, V45)		06.1994	10.1999	AKE	2	43	27		X164285	X164286
Tout / All / Alle / Tutti / Todos		12.1990	10.1999	AKE	1	43	18		X165057	X165058

X=1 : SNRA - X=2 : EAI - X=3 : SERA - X=4 : SEEAC - X=5 : NEOTO - X=6 : STARTCAR

Affectations par Marques

Vehicule application - Zuordnung nach Marke und Fahrzeuge - Applicazione per marca e veicolo - Aplicacion por marca y vehiculo



MITSUBISHI



PAJERO III (V6_W, V7_W)

2.5 TDi		04.2000	12.2006	AKE	2	43	24/Ø276		X164227	X164228
		04.2000	12.2006	SUMITOMO	2	45	26/Ø290		X644151	X644152
		04.2000	12.2006	SUMITOMO	1	43	18		X645019	X645020
		09.2001	12.2006	AKE	1	45	22		X165147	X165148
3.2 Di-D		04.2000	12.2006	SUMITOMO	2	45	26/Ø290		X644151	X644152
		04.2000	12.2006	AKE	1	45	22		X165147	X165148
3.5		04.2000	01.2007	SUMITOMO	2	45	26/Ø290		X644151	X644152
		04.2000	01.2007	AKE	1	45	22		X165147	X165148

PAJERO IV (V8_, V9_)

3.0 4WD		02.2007		SUMITOMO	2	45	26/Ø290		X644151	X644152
3.2 DI-D		11.2006	05.2011	SUMITOMO	2	45	26/Ø290		X644151	X644152
		11.2006	05.2011	SUMITOMO	4	45	28/Ø332		X644217	X644218
3.2 DI-D 4WD		02.2007		SUMITOMO	2	45	26/Ø290		X644151	X644152
		02.2007		SUMITOMO	4	45	28/Ø332		X644217	X644218
3.2 TD 4WD		01.2009		SUMITOMO	2	45	26		X644177	X644178
		01.2009		SUMITOMO	2	45	26/Ø290		X644151	X644152
		01.2009		SUMITOMO	4	45	28/Ø332		X644217	X644218
3.8 V6		02.2007		SUMITOMO	2	45	26/Ø290		X644151	X644152
		02.2007		SUMITOMO	4	45	28/Ø332		X644217	X644218
Tout / All / Alle / Tutti / Todos		02.2007		AKE	1	45	22/Ø300		X165147	X165148
		02.2007		SUMITOMO	1	48	18/Ø332		X645051	X645052

PAJERO PININ (H6, H7)

Tout / All / Alle / Tutti / Todos		10.1999	06.2007	SUMITOMO	1	57	22		X644149	X644150
		10.1999	06.2007	AKE	1	35	10		X165127	X165128

PAJERO SPORT I (K90)

2.5 TD		12.1999	01.2008	SUMITOMO	1	43	18		X645019	X645020
2.5 TD (K94W)		11.1998	02.2009	SUMITOMO	1	43	18		X645019	X645020
3.0 V6		12.1999	01.2008	SUMITOMO	1	43	18		X645019	X645020
3.0 V6 (K96W)		11.1998	10.2000	AKE	1	43	18		X165057	X165058
		11.1998	09.2001	SUMITOMO	1	43	18		X645019	X645020
Tout / All / Alle / Tutti / Todos		11.1998		AKE	2	43	24/Ø276		X164227	X164228

PAJERO SPORT II (KG_, KH_)

Tout / All / Alle / Tutti / Todos		07.2008		TOKICO	1	60	28		X674089	X674090
		07.2008		SUMITOMO	1	43	18		X645019	X645020

SANTANO

2.0 V16		05.1999	12.2004	MANDO	1	57	24		X484017	X484018
		05.1999	12.2004	MANDO	2	43	24		X484033	X484034
		05.1999	12.2004	MANDO	1	38	10		X485011	X485012
		05.1999	12.2004	MANDO	1	38	10		X485012	X485011

Affectations par Marques

Vehicule application - Zuordnung nach Marke und Fahrzeuge - Applicazione per marca e veicolo - Aplicacion por marca y vehiculo



MITSUBISHI



SIGMA (F2_A, F1_A)

Tout / All / Alle / Tutti / Todos		12.1990	07.1996	AKE	2	43	24		X164219	X164220
		12.1990	07.1996	AKE	1	35	18		X165093	X165094

SPACE GEAR

Tout / All / Alle / Tutti / Todos		12.1994	01.2007	AKE	1	60	24		X164239	X164240
		12.1994	01.2007	AKE	2	43	24		X164227	X164228
		12.1994	01.2007	AKE	1	38	18		X165123	X165124

SPACE RUNNER I (N1_W, N2_W)

Tout / All / Alle / Tutti / Todos		10.1991	08.1999	AKE	1	54	24		X164201	X164202
		10.1991	08.1999	AKE	1	35	10		X165127	X165128

SPACE RUNNER II (N6_W)

Tout / All / Alle / Tutti / Todos		08.1999	08.2002	AKE	1	60	24		X164287	X164288
		08.1999	08.2002	AKE	2	43	24		X164207	X164208
		08.1999	08.2002	AKE	1	35	10		X165127	X165128

SPACE STAR (DG_A)

Tout / All / Alle / Tutti / Todos		06.1998	12.2004	GIRL-TRW	1	54	24/Ø256		X374401	X374402
		06.1998	12.2004	GIRL-TRW	1	54	24/Ø281		X374419	X374420
		06.1998	12.2004	GIRL-TRW	1	38	10		X375233	X375234

SPACE WAGON I (D0_V/W)

1.8 4WD (D05V, D05W)		10.1987	08.1988	AKE	1	54	18		X164097	X164098
1.8 GLX (D05V, D05W)		01.1984	12.1988	AKE	1	54	18		X164097	X164098
1.8 TD (D09V, D09W)		06.1986	04.1991	AKE	1	54	18		X164097	X164098
2.0 4WD (D08W)		03.1985	11.1986	AKE	1	54	24		X164103	X164104
2.0 GLX (D04W)		06.1986	12.1988	AKE	1	54	18		X164097	X164098
2.0 GLX 4WD (D08W)		06.1986	12.1992	AKE	1	54	24		X164103	X164104

SPACE WAGON II (N3_W, N4_W)

Tout / All / Alle / Tutti / Todos		10.1991	10.1998	AKE	1	54	24	#ID: AD542414_	X164201	X164202
		10.1991	10.1998	AKE	1	60	24	#ID: AD602414_	X164209	X164210
		10.1991	10.1998	AKE	1	35	10		X165127	X165128

SPACE WAGON III (N9_W, N8_W)

Tout / All / Alle / Tutti / Todos		10.1998	12.2004	AKE	2	43	24		X164207	X164208
		10.1998	12.2004	AKE	1	38	20		X165165	X165166

STARION (A18_A)

Tout / All / Alle / Tutti / Todos		06.1982	01.1990	SUMITOMO	1	57	12,5		X644051	X644052
		06.1982	01.1990	AKE	1	41	10		X165033	X165034



MONICA



MONICA V8

Tout / All / Alle / Tutti / Todos		01.1972	12.1974	LOCK	4	38			X464113	X464114
		01.1972	12.1974	GIRL-TRW	2	30/43			X375317	X375318

Affectations par Marques

Vehicule application - Zuordnung nach Marke und Fahrzeuge - Applicazione per marca e veicolo - Aplicacion por marca y vehiculo



MORGAN

FOUR FOUR

1600		01.1966		GIRL-TRW	2	48			X374477	X374478
SERIE IV		01.1961	12.1966	GIRL-TRW	2	48			X374487	X374488
SERIE V		01.1961	12.1966	GIRL-TRW	2	48			X374487	X374488
		01.1966		GIRL-TRW	2	48			X374477	X374478

PLUS FOUR

2.0 i		08.1992		LOCK	4	38			X464107	X464108
Tout / All / Alle / Tutti / Todos		01.1959	12.1966	GIRL-TRW	2	48			X374487	X374488
		01.1966		GIRL-TRW	2	48			X374477	X374478

MORRIS

MINI

1.3		09.1962	08.1969	LOCK	2	44	9,4		X464065	X464066
Cooper		01.1961	12.1967	LOCK	2	41	6,2		X464077	X464078

MULTICAR

M26

2.8		01.1996	12.2002	KNORR	2	46			X444013	X444014
2.8 D		01.2003		KNORR	2	46			X444013	X444014
3.0 D		09.2006		KNORR	2	46			X444013	X444014

NISSAN

100 NX (B13)

Tout / All / Alle / Tutti / Todos		03.1990		AKE	1	54	26		X164199	X164200
		03.1990		NISSAN	1	48	18		X554011	X554012
		03.1991		AKE	1	30	7		X165083	X165084
		03.1991		NISSAN	1	34	9		X555003	X555004

200 SX (S13)

Tout / All / Alle / Tutti / Todos		07.1988	11.1993	NISSAN	1	57	22		X554009	X554010
		07.1988	11.1993	AKE	1	35	10		X165077	X165078

200 SX (S14)

Tout / All / Alle / Tutti / Todos		10.1993	12.1999	SUMITOMO	4	40	26		X644109	X644110
		10.1993	12.1999	NISSAN	1	38			X555017	X555018

280 ZX,ZXT (HGS130)





2.8		10.1978	02.1984	SUMITOMO	1	60	20		X644089	X644090
-----	--	---------	---------	----------	---	----	----	--	---------	---------

300 ZX (Z31)

Tout / All / Alle / Tutti / Todos		01.1984	12.1987	NISSAN	2	43	26		X554029	X554030
		01.1984	12.1987	SUMITOMO	1	60	22		X644017	X644018
		04.1984	12.1989	TOKICO	1	43	10		X675023	X675024
		04.1984	12.1989	TOKICO	1	43	20		X675027	X675028

Affectations par Marques

Vehicule application - Zuordnung nach Marke und Fahrzeuge - Applicazione per marca e veicolo - Aplicacion por marca y vehiculo

								
NISSAN								
300 ZX (Z32)								
Tout / All / Alle / Tutti / Todos		09.1989	12.1997	SUMITOMO	4	40	26	X644109 X644110
		09.1989	12.1997	AKE	2	38	18	X165103 X165104
350 Z (Z33)								
Tout / All / Alle / Tutti / Todos		09.2002		BREMBO	4	^{38/44}	30	X284183 X284184
		09.2002		BREMBO	2	40	20	X285087 X285088
ALMERA I (N15)								
2.0 GTI		04.1996	07.2000	AKE	1	54	26	X164199 X164200
		04.1996	07.2000	NISSAN	1	34	9	X555011 X555012
Tout / All / Alle / Tutti / Todos		07.1995	07.2000	NISSAN	1	54	18	ABS X554039 X554040
		07.1995	07.2000	NISSAN	1	54	18	ABS X554041 X554042
		07.1995	07.2000	NISSAN	1	30	7/Ø234	X555009 X555010
		07.1995	07.2000	NISSAN	1	34	9/Ø258	X555011 X555012
ALMERA II (N16)								
Tout / All / Alle / Tutti / Todos		01.2000	09.2006	GIRL-TRW	1	57	22	 ^{14"} ABS X374415 X374416
		01.2000	09.2006	GIRL-TRW	1	57	22	 ^{15"} ABS X374417 X374418
		01.2000	09.2006	GIRL-TRW	1	34	10	#ID: 2187 2188 X375149 X375150
		01.2000	09.2006	GIRL-TRW	1	34	10	#ID: 2716 2717 X375271 X375272
		01.2000	09.2006	GIRL-TRW	1	38	10	#ID: 2722 2723 X375273 X375274
		01.2000	09.2006	NISSAN	1	34	9	#ID: T5-52 X555011 X555012
ALMERA TINO (V10)								
Tout / All / Alle / Tutti / Todos		08.2000	11.2005	GIRL-TRW	1	57	28	X374583 X374584
		08.2000	11.2005	GIRL-TRW	1	38	10	#ID: 2617 2618 X375321 X375322
		08.2000	11.2005	GIRL-TRW	1	38	10	#ID: 2722 2723 X375273 X375274
BLUEBIRD (910)								
Tout / All / Alle / Tutti / Todos		03.1980	08.1981	NISSAN	1	54	18	X554001 X554002
		09.1981	11.1983	NISSAN	1	54	18	X554003 X554004
BLUEBIRD (B610)								
Tout / All / Alle / Tutti / Todos		09.1974	06.1976	TOKICO	2	51	10	X674017 X674018
BLUEBIRD (B810)								
Tout / All / Alle / Tutti / Todos		07.1976	03.1980	NISSAN	2	54	13	X554005 X554006
BLUEBIRD (T12, T72, U11, WU11)								
Tout / All / Alle / Tutti / Todos		11.1983	12.1989	TOKICO	1	60	22	X674013 X674014
CABSTAR (E)								
Tout / All / Alle / Tutti / Todos		10.1998	12.2006	BENDIX	2	48	24	X254223 X254224
		10.1998	12.2006	BENDIX	2	52	24	X254141 X254142
		10.1998	10.2006	BOSCH	2	48	24,5	X274047 X274048
CABSTAR (F22, H40)								
Tout / All / Alle / Tutti / Todos		01.1989	12.1992	NISSAN	1	68	20	X554019 X554020
		01.1989	12.1992	NISSAN	1	68	26	X554033 X554034

Affectations par Marques

Vehicule application - Zuordnung nach Marke und Fahrzeuge - Applicazione per marca e veicolo - Aplicacion por marca y vehiculo



NISSAN



CABSTAR (F23, H41, H42)

Tout / All / Alle / Tutti / Todos		10.2006	09.2011	BREMBO	2	48	26		X284181	X284182
		10.2006	09.2011	BREMBO	2	52	26		X284091	X284092
		10.2006	09.2011	BREMBO	1	46			X285047	X285048
		10.2006	09.2011	BREMBO	2	44	22		X285037	X285038

CHERRY I (E10)

1.0		09.1970	09.1978	AKE	1	48	9,9		X164029	X164030
-----	--	---------	---------	-----	---	----	-----	--	---------	---------

CHERRY II (N10, VN10)

Tout / All / Alle / Tutti / Todos		08.1978	12.1982	TOKICO	2	48	9,6		X674023	X674024
-----------------------------------	--	---------	---------	--------	---	----	-----	--	---------	---------

CUBE III (Z12)

Tout / All / Alle / Tutti / Todos		03.2010		NISSAN	1	57	22		X554067	X554068
		03.2010		AKE	1	35	9		X165175	X165176

EBRO

2.8 / 3.0		03.1989	06.1996	BENDIX	2	48			X254223	X254224
F260 / F275		01.1978	03.1989	BENDIX	2	52			X254141	X254142
F350		01.1978	03.1989	BENDIX	2	52		#ID: 216072 / 216135	X254141	X254142
		01.1979	12.1984	BENDIX	2	52			X254225	X254226

EBRO AVIA

Tout / All / Alle / Tutti / Todos		01.1978	03.1989	BENDIX	2	52		#ID: 216072 / 216135	X254141	X254142
		01.1978	03.1989	BENDIX	2	52			X254225	X254226

FAIRLADY S (S130)

280ZX_		08.1978	07.1983	SUMITOMO	1	60	20		X644089	X644090
		08.1978	07.1983	SUMITOMO	2	43	9,6		X645001	X645002
		08.1978	07.1983	TOKICO	1	43	10		X675021	X675022

FAIRLADY Z (Z31)

Tout / All / Alle / Tutti / Todos		01.1984	12.1989	NISSAN	2	43	26		X554029	X554030
		01.1984	12.1989	SUMITOMO	1	60	22		X644095	X644096
		01.1984	12.1989	TOKICO	1	43	10		X675023	X675024
		01.1984	12.1989	TOKICO	1	43	20		X675027	X675028

INTERSTAR

Tout / All / Alle / Tutti / Todos		07.2002	03.2011	BOSCH	2	45	24			X274049	X274050
		07.2002	03.2011	BOSCH	2	45	28			X274051	X274052
		07.2002	03.2011	BOSCH	2	45	28			X274065	X274066
		07.2002	03.2011	BOSCH	1	42	12			X275023	X275024

JUKE (F15)

1.5 dCi		06.2010		NISSAN	1	57	24/Ø280		X554061	X554062
1.6		06.2010		NISSAN	1	57	24/Ø280		X554061	X554062
1.6 DIG-T		06.2010		NISSAN	1	57	26/Ø296		X554059	X554060
1.6 DIG-T 4x4		06.2010		NISSAN	1	57	26/Ø296		X554059	X554060
1.6 DIG-T NISMO		11.2012		NISSAN	1	57	26/Ø296		X554059	X554060
1.6 DIG-T NISMO 4x4		02.2013		NISSAN	1	57	26/Ø296		X554059	X554060

X=1 : SNRA - X=2 : EAI - X=3 : SERA - X=4 : SEEAC - X=5 : NEOTO - X=6 : STARTCAR

Affectations par Marques

Vehicule application - Zuordnung nach Marke und Fahrzeuge - Applicazione per marca e veicolo - Aplicacion por marca y vehiculo



NISSAN



JUKE (F15)

Tout / All / Alle / Tutti / Todos		06.2010		AKE	1	35	9		X165175	X165176
-----------------------------------	--	---------	--	-----	---	----	---	--	---------	---------

KUBISTAR (X76, X80)

Tout / All / Alle / Tutti / Todos		08.2003	10.2009	BOSCH	1	54	20/Ø238		X274003	X274004
		08.2003	10.2009	BOSCH	1	54	24/Ø280		X274075	X274076

MAXIMA III (J30)

Tout / All / Alle / Tutti / Todos		10.1988	10.1991	NISSAN	1	57	22		X554009	X554010
		10.1988	06.1994	NISSAN	2	40	26		X554027	X554028
		10.1988	06.1994	NISSAN	1	34	10		X555013	X555014

MAXIMA IV QX (A32)

2.0		02.1995	08.1997	NISSAN	1	57	22		X554009	X554010
		09.1997	08.2000	NISSAN	2	40	26		X554027	X554028
3.0		01.1995	08.1997	NISSAN	1	57	22		X554009	X554010
		09.1997	08.2000	NISSAN	2	40	26		X554027	X554028
Tout / All / Alle / Tutti / Todos		01.1995	08.2000	NISSAN	1	34	9		X555015	X555016

MAXIMA V QX (A33)

Tout / All / Alle / Tutti / Todos		03.2000	11.2003	NISSAN	1	38	9		X555021	X555022
-----------------------------------	--	---------	---------	--------	---	----	---	--	---------	---------

MICRA I (K10)

1.0		12.1982	05.1989	TOKICO	1	45	12		X674015	X674016
		12.1982	05.1989	TOKICO	1	45	15		X674057	X674058
1.2		07.1986	07.1992	TOKICO	1	45	15		X674057	X674058

MICRA II (K11)

1.0 i 16V		08.1992	02.2003	GIRL-TRW	1	48	12		X374289	X374290
		09.2000	02.2003	GIRL-TRW	1	48	18		X374603	X374604
1.3 i 16V		08.1992	09.2000	GIRL-TRW	1	48	12		X374289	X374290
1.4 i 16V		09.2000	04.2001	GIRL-TRW	1	48	18		X374603	X374604
1.5 D		02.1998	02.2003	GIRL-TRW	1	48	12		X374289	X374290
Tout / All / Alle / Tutti / Todos		08.1992	02.2003	GIRL-TRW	1	30	7		X375121	X375122

MICRA III (K12)

Tout / All / Alle / Tutti / Todos		01.2003	06.2010	GIRL-TRW	1	54	22		X374595	X374596
-----------------------------------	--	---------	---------	----------	---	----	----	--	---------	---------

MURANO I (Z50)

Tout / All / Alle / Tutti / Todos		08.2003	01.2009	NISSAN	2	45	28		X554057	X554058
		08.2003	01.2009	AKE	1	43	16		X165181	X165182

MURANO II (Z51)

Tout / All / Alle / Tutti / Todos		11.2007	09.2014	NISSAN	2	45	28		X554057	X554058
		11.2007	09.2014	AKE	1	43	16		X165203	X165204

NAVARA (D40)

Tout / All / Alle / Tutti / Todos		07.2005		NISSAN	2	43	26/Ø277		X554035	X554036
		07.2005		NISSAN	2	45	28/Ø320		X554055	X554056
		07.2005		NISSAN	2	46	28/Ø296		X554053	X554054
		07.2005		NISSAN	1	38	18		X555023	X555024

X=1 : SNRA - X=2 : EAI - X=3 : SERA - X=4 : SEEAC - X=5 : NEOTO - X=6 : STARTCAR

Affectations par Marques

Vehicule application - Zuordnung nach Marke und Fahrzeuge - Applicazione per marca e veicolo - Aplicacion por marca y vehiculo



NISSAN



NOTE (E11)

Tout / All / Alle / Tutti / Todos		03.2006	06.2012	GIRL-TRW	1	54	22		X374595	X374596
-----------------------------------	--	---------	---------	----------	---	----	----	--	---------	---------

NP300 (D40)

Tout / All / Alle / Tutti / Todos		04.2008		NISSAN	2	43	26/Ø277		X554035	X554036
-----------------------------------	--	---------	--	--------	---	----	---------	--	---------	---------

NV200 (M20, ME0)

Tout / All / Alle / Tutti / Todos		02.2010		NISSAN	1	60	26		X554065	X554066
-----------------------------------	--	---------	--	--------	---	----	----	--	---------	---------

NV400

Tout / All / Alle / Tutti / Todos		11.2011		BREMBO	2	48	28		X284171	X284172
		11.2011		BREMBO	1	48	12		X285069	X285070
		11.2011		BREMBO	1	60	12		X285081	X285082

PATHFINDER I (WD21)

Tout / All / Alle / Tutti / Todos		07.1986	02.1996	NISSAN	2	43	26/Ø277		X554035	X554036
		07.1986	02.1996	AKE	1	43	18		X165105	X165106

PATHFINDER II (R50)

Tout / All / Alle / Tutti / Todos		09.1997	12.2004	NISSAN	2	43	26/Ø277		X554035	X554036
		09.1997	12.2004	NISSAN	2	46	28/Ø300		X554051	X554052

PATHFINDER III (R51)

Tout / All / Alle / Tutti / Todos		01.2005		NISSAN	2	45	28/Ø320		X554055	X554056
		01.2005		NISSAN	2	46	28/Ø296		X554053	X554054
		01.2005		NISSAN	1	38	18		X555023	X555024

PATROL (160)

Tout / All / Alle / Tutti / Todos		07.1980	12.1988	NISSAN	1	68	20		X554043	X554044
-----------------------------------	--	---------	---------	--------	---	----	----	--	---------	---------

PATROL (260)

Tout / All / Alle / Tutti / Todos		01.1990	04.1998	GIRL-TRW	1	68	20		X374395	X374396
		01.1990	04.1998	NISSAN	1	68	20		X554045	X554046

PATROL GR I (Y60, GR)

2.8		09.1988	02.1998	NISSAN	1	68	20		X554045	X554046
4.2		09.1988	02.1998	NISSAN	1	68	20		X554045	X554046
		09.1988	02.1998	SUMITOMO	2	48	20		X644119	X644120
Tout / All / Alle / Tutti / Todos		09.1988	02.1998	AKE	1	51	20		X165133	X165134

PATROL GR II (Y61)

Tout / All / Alle / Tutti / Todos		06.1997		NISSAN	2	48	32		X554049	X554050
		06.1997		NISSAN	1	48	18		X555019	X555020

PICK UP (720)

Tout / All / Alle / Tutti / Todos		01.1982	03.1986	NISSAN	1	60	22		X554047	X554048
-----------------------------------	--	---------	---------	--------	---	----	----	--	---------	---------

PICK UP (D21)

Tout / All / Alle / Tutti / Todos		09.1985	02.1998	NISSAN	1	60	22		X554047	X554048
		09.1985	02.1998	NISSAN	2	43	26/Ø260		X554015	X554016
		09.1985	02.1998	NISSAN	2	43	26/Ø277		X554035	X554036

Affectations par Marques

Vehicule application - Zuordnung nach Marke und Fahrzeuge - Applicazione per marca e veicolo - Aplicacion por marca y vehiculo



NISSAN



PICK UP (D22)

Tout / All / Alle / Tutti / Todos		02.1998	12.2012	NISSAN	2	43	26/Ø277		X554035	X554036
		02.1998	12.2012	NISSAN	2	46	28/Ø300		X554051	X554052

PIXO (UA0)

1.0		06.2009		NISSAN	1	51	20		X554063	X554064
-----	--	---------	--	--------	---	----	----	--	---------	---------

PRAIRIE (M10, NM10)

1.5 / 1.8		07.1983	12.1987	AKE	1	51	18		X164011	X164012
2.0		07.1983	12.1987	TOKICO	1	60	22		X674013	X674014

PRAIRIE (M11)

2.0		01.1988	12.1992	NISSAN	1	57	22		X554009	X554010
2.4		04.1992	07.1994	NISSAN	1	57	25		X554031	X554032

PRIMASTAR

Tout / All / Alle / Tutti / Todos		03.2001	04.2014	GIRL-TRW	2	40/45	28		X374453	X374454
		03.2001	04.2014	GIRL-TRW	1	41	12		X375197	X375198

PRIMERA (P10)

Tout / All / Alle / Tutti / Todos		06.1990	06.1996	AKE	1	54	20		X164229	X164230
		06.1990	06.1996	BENDIX	1	54	20		X254161	X254162
		06.1990	06.1996	GIRL-TRW	1	57	22		X374281	X374282
		06.1990	06.1996	GIRL-TRW	1	34	10	4x4	X375091	X375092
		06.1990	06.1996	GIRL-TRW	1	34	10		X375089	X375090
		06.1990	06.1996	NISSAN	1	38	9		X555007	X555008

PRIMERA (P11)

Tout / All / Alle / Tutti / Todos		06.1996	07.2002	ATE	1	57	22		X224745	X224746
		06.1996	07.2002	GIRL-TRW	1	57	22		X374415	X374416
		06.1996	07.2002	GIRL-TRW	1	57	22		X374417	X374418
		06.1996	03.2001	GIRL-TRW	1	34	10		X375149	X375150
		04.2001	07.2002	GIRL-TRW	1	38	10		X375273	X375274

PRIMERA (P12)

Tout / All / Alle / Tutti / Todos		01.2002		GIRL-TRW	1	57	28		X374583	X374584
		01.2002		ATE	1	38	10		X225285	X225286

PRIMERA (W10)

Tout / All / Alle / Tutti / Todos		07.1990	12.1997	NISSAN	1	57	22		X554009	X554010
		07.1990	12.1997	NISSAN	1	38	9		X555007	X555008

PRIMERA (WP11)

Tout / All / Alle / Tutti / Todos		06.1996	12.2001	ATE	1	57	22		X224745	X224746
		06.1996	12.2001	GIRL-TRW	1	57	22		X374417	X374418
		06.1996	03.2001	GIRL-TRW	1	34	10		X375149	X375150
		04.2001	12.2001	GIRL-TRW	1	38	10		X375273	X375274

PRIMERA (WP12)

Tout / All / Alle / Tutti / Todos		01.2002		GIRL-TRW	1	57	28		X374583	X374584
		01.2002		ATE	1	38	10		X225285	X225286

X=1 : SNRA - X=2 : EAI - X=3 : SERA - X=4 : SEEAC - X=5 : NEOTO - X=6 : STARTCAR

Affectations par Marques

Vehicule application - Zuordnung nach Marke und Fahrzeuge - Applicazione per marca e veicolo - Aplicacion por marca y vehiculo



NISSAN



QASHQAI/QASHQAI+2 I (J10, JJ10)

Tout / All / Alle / Tutti / Todos		02.2007	12.2013	AKE	1	60	26		X164299	X164300
		02.2007	12.2013	NISSAN	2	45	28		X554057	X554058
		02.2007	12.2013	AKE	1	35	9		X165175	X165176
		02.2007	12.2013	AKE	1	43	16		X165191	X165192

QASHQAI/QASHQAI+2 II (J11)

Tout / All / Alle / Tutti / Todos		11.2013		AKE	1	57	26		X164333	X164334
		11.2013		GIRL-TRW	1	36	13		X377055	X377056

SERENA (C23M)

1.6 16V		02.1993	09.2001	GIRL-TRW	2	43	26		X374449	X374450
2.0 16V		11.1992	09.1993	GIRL-TRW	2	43	26		X374393	X374394
		10.1994	09.2001	GIRL-TRW	2	43	26		X374449	X374450
2.0 D		11.1992	09.1994	BENDIX	1	60	22		X254159	X254160
2.3 D		01.1995	09.2001	GIRL-TRW	2	43	26		X374449	X374450

SILVIA (S10)

Tout / All / Alle / Tutti / Todos		10.1975	08.1980	TOKICO	2	51	13		X674017	X674018
-----------------------------------	--	---------	---------	--------	---	----	----	--	---------	---------

SILVIA (S11)

Tout / All / Alle / Tutti / Todos		09.1979	09.1983	NISSAN	2	54	13		X554005	X554006
		09.1979	06.1981	TOKICO	2	40	9,6		X675033	X675034
		07.1981	09.1983	TOKICO	1	38	10		X675031	X675032

SILVIA (S12)

Tout / All / Alle / Tutti / Todos		04.1984	03.1988	SUMITOMO	1	60	22		X644017	X644018
		04.1984	03.1988	TOKICO	1	43	10		X675003	X675004

SUNNY I (B11)

1.3 / 1.5		03.1982	09.1986	TOKICO	1	48	12		X674005	X674006
1.7		03.1982	09.1986	AKE	1	51	18		X164011	X164012

SUNNY II (B12)

Tout / All / Alle / Tutti / Todos		06.1986	09.1988	TOKICO	1	48	12		X674005	X674006
		10.1988	03.1991	NISSAN	1	48	18		X554023	X554024
		10.1988	03.1991	NISSAN	1	48	20		X554025	X554026
		05.1987	03.1991	AKE	1	30	10		X165039	X165040

SUNNY II (N13)

Tout / All / Alle / Tutti / Todos		06.1986	10.1991	NISSAN	1	48	18	4WD	X554023	X554024
		06.1986	10.1991	NISSAN	1	48	18		X554013	X554014
		06.1986	03.1991	NISSAN	1	48	20		X554025	X554026
		06.1986	10.1991	TOKICO	1	48	12		X674005	X674006
		02.1987	10.1991	AKE	1	30	10		X165039	X165040

SUNNY III (N14)

1.4 / 1.6 / 2.0D		08.1990	06.1995	NISSAN	1	48	18		X554011	X554012
		08.1990	05.1995	AKE	1	30	7		X165079	X165080
		08.1990	06.1995	AKE	1	30	7		X165083	X165084

X=1 : SNRA - X=2 : EAI - X=3 : SERA - X=4 : SEEAC - X=5 : NEOTO - X=6 : STARTCAR

Affectations par Marques

Vehicule application - Zuordnung nach Marke und Fahrzeuge - Applicazione per marca e veicolo - Aplicacion por marca y vehiculo



NISSAN



SUNNY III (N14)

2.0 GTI / 2.0 i 16V		08.1990	05.1995	AKE	1	54	26		X164199	X164200
		08.1990	05.1995	NISSAN	1	34	9		X555003	X555004
		08.1990	05.1995	NISSAN	1	34	9		X555005	X555006

SUNNY III (Y10)

Tout / All / Alle / Tutti / Todos		11.1990	03.2000	AKE	1	48	18		X164139	X164140
		11.1990	03.2000	NISSAN	1	48	18		X554011	X554012

TEANA II (J32)

Tout / All / Alle / Tutti / Todos		07.2008	09.2013	NISSAN	1	57	26		X554059	X554060
-----------------------------------	--	---------	---------	--------	---	----	----	--	---------	---------

TERRANO I (WD21)

Tout / All / Alle / Tutti / Todos		10.1987		NISSAN	2	43	26		X554035	X554036
		01.1990		AKE	1	43	18		X165105	X165106

TERRANO II (R20)

2.4 4WD		05.1996	01.2002	GIRL-TRW	2	43	26		X374423	X374424
2.4 i 12V 4WD		02.1993	06.1996	GIRL-TRW	2	43	26		X374423	X374424
2.7 TD 4WD		02.1993	01.2002	GIRL-TRW	2	43	26		X374423	X374424
		02.1993	05.2000	GIRL-TRW	2	43	26		X374393	X374394
2.7 TDi 4WD		05.1996	11.2005	GIRL-TRW	2	43	26		X374423	X374424
3.0 Di 4WD		05.2002	04.2006	GIRL-TRW	2	43	26		X374423	X374424
Tout / All / Alle / Tutti / Todos		02.1993	05.1996	GIRL-TRW	2	43	26		X374393	X374394
		06.1996	12.2004	GIRL-TRW	2	43	26		X374423	X374424

TIIDA (C11X, SC11X)

Tout / All / Alle / Tutti / Todos		05.2004	06.2013	NISSAN	1	57	22		X554067	X554068
		05.2004	06.2013	AKE	1	35	9		X165175	X165176

TRAD (PF, KF, KE)

Tout / All / Alle / Tutti / Todos		01.1984	10.2001	BENDIX	2	48	24		X254223	X254224
		01.1984	10.2001	BENDIX	2	52	24		X254141	X254142

URVAN (E24)

Tout / All / Alle / Tutti / Todos		06.1986	04.1997	NISSAN	2	42	26/Ø260		X554015	X554016
-----------------------------------	--	---------	---------	--------	---	----	---------	--	---------	---------

VANETTE I (C120)

Tout / All / Alle / Tutti / Todos		06.1981	12.1986	AKE	1	51	18	Diesel	X164259	X164260
		06.1981	12.1986	AKE	1	51	18		X164191	X164192

VANETTE II (C22)

Tout / All / Alle / Tutti / Todos		10.1986	03.1995	NISSAN	2	42	26		X554015	X554016
-----------------------------------	--	---------	---------	--------	---	----	----	--	---------	---------

VANETTE III (C23) CARGO

Tout / All / Alle / Tutti / Todos		01.1993	09.1993	GIRL-TRW	2	43	26		X374393	X374394
		10.1993	05.2002	GIRL-TRW	2	43	26		X374449	X374450

X-TRAIL I (T30)

Tout / All / Alle / Tutti / Todos		06.2001	11.2007	AKE	2	45	28		X164271	X164272
		06.2001	11.2007	AKE	1	35	16		X165145	X165146

X=1 : SNRA - X=2 : EAI - X=3 : SERA - X=4 : SEEAC - X=5 : NEOTO - X=6 : STARTCAR

Affectations par Marques

Vehicule application - Zuordnung nach Marke und Fahrzeuge - Applicazione per marca e veicolo - Aplicacion por marca y vehiculo



NISSAN



X-TRAIL II (T31)										
Tout / All / Alle / Tutti / Todos		03.2007	09.2014	AKE	1	60	26		X164299	X164300
		03.2007	09.2014	AKE	1	35	16		X165195	X165196



NSU



1000										
1000C		08.1963	12.1972	ATE	2	38	8,9		X224315	X224316
1200										
1200C		09.1969	11.1971	ATE	2	38	8,9		X224391	X224392
PRINZ										
Tout / All / Alle / Tutti / Todos		08.1961	03.1974	ATE	2	38	8,9		X224315	X224316
RO 80										
Tout / All / Alle / Tutti / Todos		10.1967	07.1977	ATE	4	40	12,6		X224371	X224372



OLDSMOBILE



CUTLASS										
Tout / All / Alle / Tutti / Todos		01.1973	12.1976	K/H	1	74,6			X794005	X794006



OPEL



ADAM										
1.0		07.2014		BOSCH	1	54	22		X274071	X274072
1.2		10.2012		BOSCH	1	54	22		X274071	X274072
1.4		10.2012		BOSCH	1	54	22		X274071	X274072
1.4 LPG		07.2013		BOSCH	1	54	22		X274071	X274072
1.4 S		11.2014		ATE	1	57	25		X224429	X224430
		11.2014		BOSCH	1	54	22		X274071	X274072

ADMIRAL										
Tout / All / Alle / Tutti / Todos		01.1963	01.1978	ATE	2	54	12,7		X224333	X224334
		01.1963	01.1978	ATE	2	54	22		X224385	X224386
		01.1963	01.1978	ATE	2	42	22		X225145	X225146

AGILA (A) (H00)										
Tout / All / Alle / Tutti / Todos		09.2000	12.2007	BOSCH	1	48	12		X274057	X274058
		09.2000	12.2007	BOSCH	1	48	17		X274059	X274060

AGILA (B) (H08)										
Tout / All / Alle / Tutti / Todos		09.2007		GIRL-TRW	1	54	20		X374671	X374672

AMPERA										
EV 150		11.2011		BOSCH	1	60	26		X274107	X274108
		11.2011		ATE	1	38	12		X225405	X225406

ANTARA										
Tout / All / Alle / Tutti / Todos		05.2006		MANDO	2	45	29		X484051	X484052
		05.2006		MANDO	1	40	20		X485019	X485020

X=1 : SNRA - X=2 : EAI - X=3 : SERA - X=4 : SEEAC - X=5 : NEOTO - X=6 : STARTCAR

Affectations par Marques

Vehicule application - Zuordnung nach Marke und Fahrzeuge - Applicazione per marca e veicolo - Aplicacion por marca y vehiculo

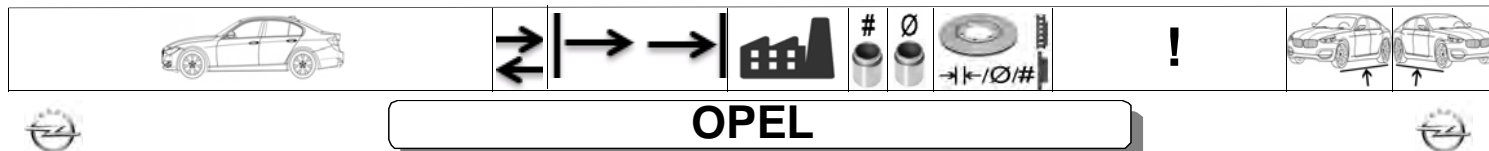

OPEL

ASCONA A (81_, 84_, 86_, 87_, 88_, 89_)

Tout / All / Alle / Tutti / Todos		01.1970	08.1975	ATE	1	48	12,7		X224379	X224380
		01.1970	08.1975	ATE	2	48	10,9		X224047	X224048
		01.1970	08.1975	ATE	2	48	22		X224393	X224394
		01.1970	08.1975	GIRL-TRW	2	48	10,9		X374057	X374058

ASCONA B (81_, 86_, 87_, 88_)

Tout / All / Alle / Tutti / Todos		10.1974	08.1981	ATE	1	48	12,7		X224379	X224380
		10.1974	08.1981	ATE	2	48	12,7		X224103	X224104
		10.1974	08.1981	DELCO	1	48	12,7		X104023	X104024
		10.1974	08.1981	GIRL-TRW	2	48	12,7		X374077	X374078

ASCONA C (81_, 84_, 86_, 87_, 88_, 89_)

Tout / All / Alle / Tutti / Todos		09.1981	08.1988	ATE	1	48	12,7		X224025	X224026
		09.1981	08.1988	ATE	1	52	24		X224045	X224046
		09.1981	08.1988	DELCO	1	48	12,7		X104015	X104016
		09.1981	08.1988	DELCO	1	52	20/Ø236		X104011	X104012
		09.1981	08.1988	DELCO	1	52	24/Ø256		X104019	X104020

ASTRA F

Tout / All / Alle / Tutti / Todos		09.1991	08.2002	ATE	1	48	12,7		X224229	X224230
		09.1991	08.2002	ATE	1	48	20/Ø236		X224195	X224196
		09.1991	08.2002	ATE	1	52	24/Ø256		X224045	X224046
		09.1991	08.2002	ATE	2	35	10		X225079	X225080

ASTRA G

Tout / All / Alle / Tutti / Todos		02.1998	12.2009	ATE	1	48	11		X224527	X224528
		02.1998	12.2009	ATE	1	52	24/Ø258		X224529	X224530
		02.1998	12.2009	ATE	1	57	25/Ø280 -308		X224521	X224522
		02.1998	05.2005	BOSCH	1	34	10		X275003	X275004
		02.1998	05.2005	BOSCH	1	36	10		X275005	X275006
		02.1998	05.2005	BOSCH	1	38	10		X275007	X275008
		02.1998	12.2009	GIRL-TRW	1	34	10		X375241	X375242
		02.1998	12.2009	GIRL-TRW	1	36	10		X375257	X375258
		02.1998	12.2009	GIRL-TRW	1	38	10		X375239	X375240

ASTRA H

Tout / All / Alle / Tutti / Todos		02.2004	05.2014	ATE	1	57	25		X224521	X224522
		02.2004	05.2014	GIRL-TRW	1	34	10		X375301	X375302
		02.2004	05.2014	GIRL-TRW	1	36	10		X375303	X375304
		02.2004	05.2014	GIRL-TRW	1	38	10		X375305	X375306

Affectations par Marques

Vehicule application - Zuordnung nach Marke und Fahrzeuge - Applicazione per marca e veicolo - Aplicacion por marca y vehiculo



OPEL



ASTRA J

Tout / All / Alle / Tutti / Todos		12.2009		BOSCH	1	60	26/Ø276		X274105	X274106
		12.2009		BOSCH	1	60	26/Ø300		X274107	X274108
		12.2009		BREMBO	4	40/44	30		X284145	X284146
		12.2009		MANDO	1	60	30		X484059	X484060
		12.2009		ATE	1	38	12		X225405	X225406
		12.2009		ATE	1	38	12		X225407	X225408
		12.2009		ATE	1	40	12		X225423	X225424

CALIBRA A (85_)

Tout / All / Alle / Tutti / Todos		06.1990	07.1997	ATE	1	52	24/Ø256		X224045	X224046
		06.1990	07.1997	ATE	1	54	24/Ø258		X224037	X224038
		06.1990	07.1997	ATE	1	54	24/Ø284		X224275	X224276
		06.1990	07.1997	ATE	1	57	25/Ø280		X224429	X224430
		03.1992	07.1995	ATE	2	33	10		X225073	X225074
		03.1992	07.1997	ATE	2	35	10		X225079	X225080

CAMPO (TF_)

Tout / All / Alle / Tutti / Todos		09.1989	07.2003	AKE	1	60	22	2WD	X164117	X164118
		09.1989	07.2003	AKE	1	60	22	4WD	X164197	X164198

CASCADE (W13)

1.4		03.2013		ATE	1	38	12		X225405	X225406
		03.2013		ATE	1	38	12		X225407	X225408
Tout / All / Alle / Tutti / Todos		03.2013		BOSCH	1	60	26/Ø276		X274105	X274106
		03.2013		BOSCH	1	60	26/Ø300		X274107	X274108
		03.2013		MANDO	1	60	30/Ø321		X484059	X484060

COMBO I (71_)

Tout / All / Alle / Tutti / Todos		07.1994	10.2001	ATE	1	48	12,7		X224229	X224230
		07.1994	10.2001	ATE	1	48	20		X224195	X224196

COMBO II

Tout / All / Alle / Tutti / Todos		10.2001	12.2011	ATE	1	57	25		X224429	X224430
		10.2001	12.2011	GIRL-TRW	1	54	24		X374503	X374504
		10.2001	12.2011	GIRL-TRW	1	38	10		X375305	X375306

COMBO III (X12)

Tout / All / Alle / Tutti / Todos		02.2012		ATE	1	57	28/Ø305		X224851	X224852
		02.2012		BOSCH	1	54	22/Ø284		X274079	X274080

COMMODORE A

2.5		01.1967	12.1971	ATE	2	54	12,7		X224021	X224022
-----	--	---------	---------	-----	---	----	------	--	---------	---------

COMMODORE B

Tout / All / Alle / Tutti / Todos		01.1972	07.1978	ATE	2	54	12,7		X224083	X224084
		01.1972	07.1978	ATE	2	54	22		X224085	X224086
		01.1972	07.1978	ATE	2	40	11		X225037	X225038

Affectations par Marques

Vehicule application - Zuordnung nach Marke und Fahrzeuge - Applicazione per marca e veicolo - Aplicacion por marca y vehiculo



OPEL



COMMODORE C (14_, 19_)

Tout / All / Alle / Tutti / Todos		08.1978	12.1982	ATE	2	54	12,7		->11001886	X224399	X224400
		08.1978	12.1982	ATE	2	57	12,7		11001887->	X224073	X224074
		05.1981	12.1982	ATE	2	54	22			X224071	X224072

COMMODORE C (61) Break

Tout / All / Alle / Tutti / Todos		12.1980	12.1983	ATE	2	57	22			X224165	X224166
-----------------------------------	--	---------	---------	-----	---	----	----	--	--	---------	---------

CORSA A

Tout / All / Alle / Tutti / Todos		09.1982	03.1993	ATE	1	48	12,7			X224229	X224230
		09.1982	03.1993	ATE	1	48	20			X224195	X224196
		09.1982	03.1993	DELCO	1	48	10			X104001	X104002
		09.1982	03.1993	DELCO	1	48	12,7			X104015	X104016
		09.1982	03.1993	DELCO	1	52	20			X104011	X104012

CORSA B

Tout / All / Alle / Tutti / Todos		03.1993	09.2000	ATE	1	48	12,7			X224229	X224230
		03.1993	09.2000	ATE	1	48	20			X224195	X224196

CORSA C

Tout / All / Alle / Tutti / Todos		09.2000	09.2006	ATE	1	57	25			X224429	X224430
		09.2000	09.2006	GIRL-TRW	1	48	11/Ø240	ABS		X374519	X374520
		09.2000	09.2006	GIRL-TRW	1	48	20/Ø240	ABS		X374517	X374518
		09.2000	09.2006	GIRL-TRW	1	54	24/Ø260			X374503	X374504
		09.2000	09.2006	GIRL-TRW	1	34	10			X375265	X375266

CORSA D

Tout / All / Alle / Tutti / Todos		07.2006	08.2014	BOSCH	1	54	12			X274077	X274078
		07.2006	08.2014	BOSCH	1	54	22/Ø257			X274071	X274072
		07.2006	08.2014	BOSCH	1	54	22/Ø284			X274079	X274080
		07.2006	08.2014	BOSCH	1	57	26/Ø278			X274099	X274100
		07.2006	08.2014	BOSCH	1	36	10			X275047	X275048

DIPLOMAT A

4.6		10.1964	03.1969	ATE	2	54	12,7			X224333	X224334
5.4		03.1965	03.1969	ATE	2	57	12,7			X224359	X224360

DIPLOMAT B

2.8 / 5.4		03.1969	07.1978	ATE	2	54	22			X224385	X224386
		03.1969	07.1978	ATE	2	42	22			X225145	X225146

FRONTERA A (5_MWL4)

2.2 i (54MWL4)		03.1995	10.1998	AKE	1	60	26			X164223	X164224
2.3 TD (5JMWL4)		03.1992	10.1998	AKE	1	60	22			X164117	X164118
2.4 i (53MWL4)		03.1992	10.1998	AKE	1	60	22			X164117	X164118
2.5 TDS		09.1996	10.1998	AKE	1	60	26			X164223	X164224
2.8 TD (5BMW4)		03.1995	10.1998	AKE	1	60	26			X164223	X164224
Tout / All / Alle / Tutti / Todos		03.1995	10.1998	AKE	1	42	18			X165055	X165056

X=1 : SNRA - X=2 : EAI - X=3 : SERA - X=4 : SEEAC - X=5 : NEOTO - X=6 : STARTCAR

Affectations par Marques

Vehicule application - Zuordnung nach Marke und Fahrzeuge - Applicazione per marca e veicolo - Aplicacion por marca y vehiculo



OPEL



FRONTERA A (5_SUD2) SPORT

2.0 i (52SUD2, 55SUD2)		03.1992	08.1995	AKE	1	60	22		X164117	X164118
		03.1992	10.1998	AKE	1	60	26		X164223	X164224
2.5 TDS		09.1996	10.1998	AKE	1	60	26		X164223	X164224
2.8 TD (53SUD2)		03.1995	08.1996	AKE	1	60	26		X164223	X164224
Tout / All / Alle / Tutti / Todos		03.1992	10.1998	AKE	1	42	18		X165055	X165056

FRONTERA B (6B_)

Tout / All / Alle / Tutti / Todos		10.1998	02.2005	AKE	1	60	26		X164223	X164224
		10.1998	02.2005	AKE	1	42	18		X165055	X165056

GT I

1.1		09.1968	12.1970	ATE	2	45	11		X224049	X224050
1.9		09.1968	08.1973	ATE	2	48	11		X224339	X224340

GT II

2.0		06.2007	12.2011	AKE	1	60	26		X164329	X164330
		06.2007	12.2011	ATE	1	40	12		X225453	X225454

INSIGNIA A

2.8 V6 Turbo OPC 4x4		07.2009		BREMBO	4	40/44	30		X284145	X284146
		07.2009		GIRL-TRW	1	41	23/Ø315		X375423	X375424
		07.2009		GIRL-TRW	1	41	23/Ø315		X375427	X375428
Tout / All / Alle / Tutti / Todos		07.2008		GIRL-TRW	2	42	30		X374691	X374692
		07.2008		MANDO	1	60	30/Ø296		X484057	X484058
		07.2008		MANDO	1	60	30/Ø321		X484059	X484060
		07.2009		BREMBO	4	40/44	30		X284145	X284146
		07.2008		GIRL-TRW	1	41	12/Ø292		X375429	X375430
		07.2008		GIRL-TRW	1	41	12/Ø292		X375431	X375432
		07.2008		GIRL-TRW	1	41	23/Ø315		X375423	X375424
		07.2008		GIRL-TRW	1	41	23/Ø315		X375425	X375426

KADETT B

Tout / All / Alle / Tutti / Todos		09.1965	08.1973	ATE	2	44	11		->1234067	X224329	X224330
		09.1965	08.1973	ATE	2	44	11		1234068->	X224027	X224028
		09.1965	08.1973	ATE	2	45	11			X224049	X224050
		09.1965	08.1973	ATE	2	48	11		S-RALLYE	X224339	X224340
		09.1965	08.1973	ATE	2	48	22		S-RALLYE	X224357	X224358

KADETT C

Tout / All / Alle / Tutti / Todos		01.1974	07.1979	ATE	2	48	11/Ø238		X224087	X224088
		01.1974	07.1979	ATE	2	48	12,7/Ø246		X224103	X224104
		01.1974	07.1979	GIRL-TRW	2	48	11/Ø237		X374059	X374060
		01.1974	07.1979	GIRL-TRW	2	48	12,7/Ø246		X374077	X374078

Affectations par Marques

Vehicule application - Zuordnung nach Marke und Fahrzeuge - Applicazione per marca e veicolo - Aplicacion por marca y vehiculo



OPEL



KADETT D

Tout / All / Alle / Tutti / Todos		08.1979	08.1984	ATE	1	48	10		X224031	X224032
		08.1979	08.1984	ATE	1	48	10		X224335	X224336
		08.1979	08.1984	ATE	1	48	10		X224337	X224338
		08.1979	08.1984	DELCO	1	48	10		X104001	X104002
		08.1979	08.1984	DELCO	1	48	10		X104005	X104006
		08.1979	08.1984	DELCO	1	52	20		X104011	X104012

KADETT E

Tout / All / Alle / Tutti / Todos		09.1984	07.1994	ATE	1	48	10		X224031	X224032
		09.1984	07.1994	ATE	1	48	12,7		X224025	X224026
		09.1984	07.1994	ATE	1	48	20/Ø236		X224195	X224196
		09.1984	07.1994	ATE	1	52	24/Ø256		X224045	X224046
		09.1984	07.1994	DELCO	1	48	10		X104001	X104002
		09.1984	07.1994	DELCO	1	48	12,7		X104015	X104016
		09.1984	07.1994	DELCO	1	52	20/Ø236		X104011	X104012
		09.1984	07.1994	DELCO	1	52	24/Ø256		X104019	X104020
		09.1984	07.1994	ATE	2	35	10		X225079	X225080

KAPITÄN A

Tout / All / Alle / Tutti / Todos		03.1964	12.1968	ATE	2	54	12,7		X224333	X224334
-----------------------------------	--	---------	---------	-----	---	----	------	--	---------	---------

MANTA A

Tout / All / Alle / Tutti / Todos		09.1970	09.1974	ATE	2	48	10,9		X224047	X224048
		09.1970	09.1974	ATE	2	48	22		X224393	X224394
		09.1970	09.1974	GIRL-TRW	2	48	10,9		X374057	X374058

MANTA B

Tout / All / Alle / Tutti / Todos		10.1974	12.1988	ATE	1	48	12,7		X224379	X224380
		10.1974	12.1988	ATE	2	48	12,7		X224103	X224104
		10.1974	12.1988	DELCO	1	48	12,7		X104021	X104022
		10.1974	12.1988	DELCO	1	48	12,7		X104023	X104024
		10.1974	12.1988	GIRL-TRW	2	48	12,7		X374077	X374078

MERIVA A

Tout / All / Alle / Tutti / Todos		05.2003	05.2010	ATE	1	57	25		X224429	X224430
		05.2003	05.2010	GIRL-TRW	1	54	24		X374503	X374504
		05.2003	05.2010	GIRL-TRW	1	36	10	Ø=3 896 / 897	X375257	X375258
		05.2003	05.2010	GIRL-TRW	1	36	10	Ø=6 896 / 897	X375303	X375304
		05.2003	05.2010	GIRL-TRW	1	38	10	Ø=3 878 / 879	X375239	X375240
		05.2003	05.2010	GIRL-TRW	1	38	10	Ø=6 878 / 879	X375305	X375306

MERIVA B

Tout / All / Alle / Tutti / Todos		06.2010		ATE	1	57	25		X224429	X224430
		06.2010		GIRL-TRW	1	38	10		X375305	X375306

MOKKA

Tout / All / Alle / Tutti / Todos		06.2012		BOSCH	1	60	26		X274107	X274108
		06.2012		ATE	1	38	12		X225407	X225408

X=1 : SNRA - X=2 : EAI - X=3 : SERA - X=4 : SEEAC - X=5 : NEOTO - X=6 : STARTCAR

Affectations par Marques

Vehicule application - Zuordnung nach Marke und Fahrzeuge - Applicazione per marca e veicolo - Aplicacion por marca y vehiculo

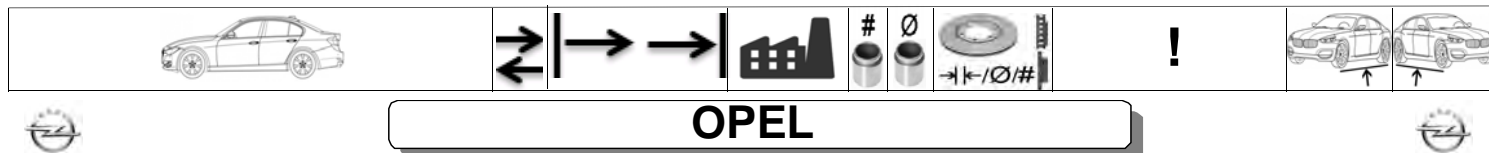

OPEL

MONTEREY A/B

Tout / All / Alle / Tutti / Todos		09.1991	08.1999	AKE	1	60	26		X164223	X164224
		09.1991	08.1999	AKE	1	42	18		X165055	X165056

MONZA A

2.0 E		03.1983	10.1984	ATE	1	48	12,7		X224395	X224396
		03.1983	10.1984	ATE	2	57	12,7		X224073	X224074
		03.1983	10.1984	ATE	2	57	22		X224165	X224166
		03.1983	10.1984	ATE	2	40	10,5		X225057	X225058
		03.1983	10.1984	ATE	2	40	10,5		X225067	X225068
2.2 E		11.1984	08.1985	ATE	1	60	22		X224201	X224202
		11.1984	08.1985	ATE	2	40	10,5		X225067	X225068
2.5 E		05.1981	08.1986	ATE	1	60	22		X224201	X224202
		05.1981	08.1986	ATE	2	57	22		X224165	X224166
		05.1981	08.1986	ATE	2	40	10,5		X225057	X225058
		05.1981	08.1986	ATE	2	40	10,5		X225067	X225068
3.0		02.1978	08.1986	ATE	2	54	22		X224071	X224072
		02.1978	08.1986	ATE	2	57	22		X224165	X224166
Tout / All / Alle / Tutti / Todos		02.1978	08.1986	ATE	2	38	10,5	->1110928	X225051	X225052
		02.1978	08.1986	ATE	2	40	10,5	1110929- >1119585	X225057	X225058
		02.1978	08.1986	ATE	2	40	10,5	1110929- >1119585	X225067	X225068

MONZA E

Tout / All / Alle / Tutti / Todos		09.1984	12.1993	ATE	1	48	12,7		X224025	X224026
		09.1984	12.1993	ATE	1	60	24		X224061	X224062
		09.1984	12.1993	DELCO	1	48	12,5		X104016	X104017
		09.1984	12.1993	ATE	2	38	10,5	->1110928	X225051	X225052
		09.1984	12.1993	ATE	2	40	10,5	1110929- >1119585	X225057	X225058
		09.1984	12.1993	ATE	2	40	10,5	1110929- >1119585	X225067	X225068

MOVANO A

Tout / All / Alle / Tutti / Todos		07.1998	11.2010	BOSCH	2	45	24	15"	X274049	X274050
		07.1998	11.2010	BOSCH	2	45	28	16"	X274051	X274052
		07.1998	11.2010	BOSCH	2	45	28	ABS	X274065	X274066
		07.1998	11.2010	BOSCH	1	42	12		X275023	X275024

MOVANO B

2.3 CDTI		05.2010		BREMBO	2	48	28		X284171	X284172
		05.2010		BREMBO	1	48	12		X285069	X285070
		05.2010		BREMBO	1	60	12		X285081	X285082

Affectations par Marques

Vehicule application - Zuordnung nach Marke und Fahrzeuge - Applicazione per marca e veicolo - Aplicacion por marca y vehiculo



OPEL



OMEGA A

Tout / All / Alle / Tutti / Todos		08.1986	04.1994	ATE	1	54	24/Ø258		X224037	X224038
		08.1986	04.1994	ATE	1	60	24/Ø280		X224061	X224062
		08.1986	04.1994	DELCO	1	54	12,7		X104017	X104018
		08.1986	04.1994	DELCO	1	54	24		X104009	X104010
		08.1986	04.1994	GIRL-TRW	1	57	28		X374179	X374180
		08.1986	04.1994	ATE	2	35	10		X225025	X225026
		08.1986	04.1994	ATE	2	35	10		X225069	X225070
		08.1986	04.1994	ATE	2	38	10		X225023	X225024
		08.1986	04.1994	ATE	2	40	10		X225075	X225076

OMEGA B

Tout / All / Alle / Tutti / Todos		03.1994	07.2003	ATE	1	54	24		X224427	X224428
		03.1994	07.2003	GIRL-TRW	1	57	28		X374179	X374180
		03.1994	07.2003	ATE	2	40	12		X225113	X225114
		03.1994	07.2003	ATE	2	42	20		X225233	X225234

REKORD A

Tout / All / Alle / Tutti / Todos		01.1963	12.1965	ATE	2	45	11		X224681	X224682
-----------------------------------	--	---------	---------	-----	---	----	----	--	---------	---------

REKORD B

Tout / All / Alle / Tutti / Todos		01.1965	02.1967	ATE	2	45	11		X224327	X224328
-----------------------------------	--	---------	---------	-----	---	----	----	--	---------	---------

REKORD C

Tout / All / Alle / Tutti / Todos		08.1966	12.1971	ATE	2	45	11		X224327	X224328
		08.1966	12.1971	ATE	2	48	10,9		X224019	X224020
		08.1966	12.1971	ATE	2	54	12,7		X224021	X224022

REKORD D

Tout / All / Alle / Tutti / Todos		01.1972	12.1977	ATE	2	48	10,9/Ø237		X224029	X224030
		01.1972	12.1977	ATE	2	48	12,7/Ø246		X224103	X224104

REKORD E

Tout / All / Alle / Tutti / Todos		01.1977	08.1986	ATE	1	52	12,7		X224151	X224152
		01.1977	08.1986	ATE	1	52	23		X224059	X224060
		01.1977	08.1986	DELCO	1	48	12,7		X104013	X104014
		01.1977	08.1986	DELCO	1	52	12,7		X104007	X104008
		01.1977	08.1986	DELCO	1	52	20		X104003	X104004

SENATOR A

2.0 E		03.1983	10.1984	ATE	2	40	10,5		1110929- >1119585	X225057	X225058
		03.1983	10.1984	ATE	2	40	10,5		1110929- >1119585	X225067	X225068
2.5		05.1978	12.1980	ATE	2	38	10,5		->1110928	X225051	X225052
Tout / All / Alle / Tutti / Todos		05.1978	08.1987	ATE	1	48	12,7			X224395	X224396
		05.1978	08.1987	ATE	1	60	22			X224201	X224202
		05.1978	08.1987	ATE	2	54	22		->1110928	X224071	X224072
		05.1978	08.1987	ATE	2	57	12,7			X224073	X224074
		05.1978	08.1987	ATE	2	57	22		1110929->	X224165	X224166

X=1 : SNRA - X=2 : EAI - X=3 : SERA - X=4 : SEEAC - X=5 : NEOTO - X=6 : STARTCAR

Affectations par Marques

Vehicule application - Zuordnung nach Marke und Fahrzeuge - Applicazione per marca e veicolo - Aplicacion por marca y vehiculo



OPEL



SENATOR B

Tout / All / Alle / Tutti / Todos		01.1988	09.1993	ATE	1	60	24		X224061	X224062
		01.1988	09.1993	GIRL-TRW	1	57	28		X374179	X374180
		01.1988	09.1993	ATE	2	38	10		X225023	X225024
		01.1988	09.1993	ATE	2	40	10		X225075	X225076

SIGNUM

Tout / All / Alle / Tutti / Todos		05.2003		ATE	1	57	25/Ø285	#ID: 6002	X224635	X224636
		05.2003		ATE	1	57	25/Ø285	#ID: 781 782	X224625	X224626
		05.2003		ATE	1	57	28/Ø302	#ID: 779 780	X224693	X224694
		05.2003		ATE	1	57	28/Ø345		X224709	X224710
		05.2003		ATE	1	60	28/Ø302	#ID: 6003	X224703	X224704
		05.2003		ATE	1	60	28/Ø314		X224707	X224708
		05.2003		ATE	1	40	12/Ø278	#ID: 983 / 973 984 / 974	X225339	X225340
		05.2003		ATE	1	40	12/Ø278	#ID: 993 / 959 994 / 960	X225337	X225338
		05.2003		ATE	1	40	20/Ø292		X225401	X225402
		05.2003		ATE	1	40	20/Ø292		X225403	X225404

SINTRA

Tout / All / Alle / Tutti / Todos		11.1996	04.1999	K/H	1	63,5	32		X794085	X794086
		11.1996	04.1999	AKE	1	38	11		X165151	X165152

SPEEDSTER

Tout / All / Alle / Tutti / Todos		09.2000		BREMBO	1	36	10		X285019	X285020
-----------------------------------	--	---------	--	--------	---	----	----	--	---------	---------

TIGRA I

1.4 16V		07.1994	12.2000	ATE	1	48	12,7		X224229	X224230
1.6 16V		07.1994	08.1998	ATE	1	48	20		X224195	X224196

TIGRA II TwinTop

Tout / All / Alle / Tutti / Todos		06.2004		GIRL-TRW	1	54	24		X374503	X374504
		06.2004		GIRL-TRW	1	34	10		X375265	X375266

VECTRA A

Tout / All / Alle / Tutti / Todos		04.1988	11.1995	ATE	1	48	12,7		X224025	X224026
		04.1988	11.1995	ATE	1	48	20/Ø236		X224195	X224196
		04.1988	11.1995	ATE	1	52	24/Ø256		X224045	X224046
		04.1988	11.1995	ATE	1	54	24/Ø258		X224037	X224038
		04.1988	11.1995	ATE	1	54	24/Ø284		X224275	X224276
		04.1988	11.1995	DELCO	1	52	24		X104011	X104012
		04.1988	11.1995	ATE	2	33	10		X225073	X225074
		04.1988	11.1995	ATE	2	35	10		X225079	X225080

VECTRA B

Tout / All / Alle / Tutti / Todos		09.1995	04.2002	ATE	1	52	24/Ø256		X224045	X224046
		09.1995	04.2002	ATE	1	57	25/Ø280 -308		X224429	X224430
		09.1995	08.1998	ATE	2	35	10		X225163	X225164
		09.1998	04.2002	ATE	2	35	10		X225219	X225220

Affectations par Marques

Vehicule application - Zuordnung nach Marke und Fahrzeuge - Applicazione per marca e veicolo - Aplicacion por marca y vehiculo



OPEL



VECTRA C

Tout / All / Alle / Tutti / Todos		04.2002		ATE	1	57	25/Ø285	#ID: 6002	X224635	X224636
		04.2002		ATE	1	57	25/Ø285	#ID: 781 782	X224625	X224626
		04.2002		ATE	1	57	28/Ø302	#ID: 779 780	X224693	X224694
		04.2002		ATE	1	57	28/Ø345		X224709	X224710
		04.2002		ATE	1	60	28/Ø302	#ID: 6003	X224703	X224704
		04.2002		ATE	1	60	28/Ø314		X224707	X224708
		04.2002		ATE	1	38	12/Ø278		X225277	X225278
		04.2002		ATE	1	38	20/Ø292		X225303	X225304
		04.2002		ATE	1	40	12/Ø278	#ID: 983 / 973 984 / 974	X225339	X225340
		04.2002		ATE	1	40	12/Ø278	#ID: 993 / 959 994 / 960	X225337	X225338
		04.2002		ATE	1	40	20/Ø292		X225401	X225402
		04.2002		ATE	1	40	20/Ø292		X225403	X225404

VIVARO I

Tout / All / Alle / Tutti / Todos		08.2001	05.2014	GIRL-TRW	2	40/45	28		X374453	X374454
		08.2001	05.2014	GIRL-TRW	1	41	12		X375197	X375198

ZAFIRA A

Tout / All / Alle / Tutti / Todos		04.1999	06.2005	ATE	1	57	25		X224521	X224522
		04.1999	06.2005	BOSCH	1	38	10		X275007	X275008
		04.1999	07.2003	GIRL-TRW	1	38	10		X375239	X375240
		08.2003	06.2005	GIRL-TRW	1	38	10		X375305	X375306

ZAFIRA B

Tout / All / Alle / Tutti / Todos		07.2005	12.2014	ATE	1	57	25		X224521	X224522
		07.2005	12.2014	GIRL-TRW	1	41	10		X375367	X375368

ZAFIRA C

1.8 LPG		10.2011		ATE	1	57	25		X224521	X224522
		10.2011		GIRL-TRW	1	41	10		X375367	X375368
Tout / All / Alle / Tutti / Todos		10.2011		BOSCH	1	60	26		X274107	X274108
		10.2011		MANDO	1	60	30		X484059	X484060
		10.2011		ATE	1	38	12		X225405	X225406
		10.2011		ATE	1	40	12		X225415	X225416
		10.2011		ATE	1	40	12		X225423	X225424



PANHARD



BT24

Tout / All / Alle / Tutti / Todos		09.1964		BENDIX	1	40			X254235	X254236
		09.1964		BENDIX	1	40			X254237	X254238

CT24

Tout / All / Alle / Tutti / Todos		09.1964		BENDIX	1	40			X254235	X254236
		09.1964		BENDIX	1	40			X254237	X254238
		09.1964		BENDIX	1	38			X255065	X255066

Affectations par Marques

Vehicule application - Zuordnung nach Marke und Fahrzeuge - Applicazione per marca e veicolo - Aplicacion por marca y vehiculo



PANHARD



KALLISTA

2.9 i		01.1990	12.1992	GIRL-TRW	2	54	24		X374485	X374486
-------	--	---------	---------	----------	---	----	----	--	---------	---------



PEUGEOT



104

Tout / All / Alle / Tutti / Todos		01.1972	12.1984	ATE	1	48	10		X224107	X224108
		01.1972	06.1975	BENDIX	1	48	10		X254183	X254184
		07.1975	01.1978	BENDIX	1	48	10		X254187	X254188
		02.1978	12.1985	BENDIX	1	48	10		X254083	X254084
		08.1979	12.1985	CITROEN	2	45	9		X314011	X314012

106

Tout / All / Alle / Tutti / Todos		08.1991	05.2005	ATE	1	45	8/#3		X224209	X224210
		08.1991	05.2005	ATE	1	48	20,4		X224247	X224248
		08.1991	05.2005	BENDIX	1	48	10		X254087	X254088
		08.1991	05.2005	BENDIX	1	48	20,4		X254013	X254014
		08.1991	05.2005	BENDIX	1	48	20,4		X254113	X254114
		05.1996	05.2005	BENDIX	1	30	8		X255007	X255008

107

Tout / All / Alle / Tutti / Todos		06.2005		BOSCH	1	48	20		X274087	X274088
-----------------------------------	--	---------	--	-------	---	----	----	--	---------	---------

108

Tout / All / Alle / Tutti / Todos		05.2014		BOSCH	1	48	20		X274087	X274088
-----------------------------------	--	---------	--	-------	---	----	----	--	---------	---------

204

Tout / All / Alle / Tutti / Todos		09.1966	08.1968	GIRL-TRW	2	48	10		X374313	X374314
		09.1968	05.1975	GIRL-TRW	2	48	10		X374311	X374312
		07.1969	07.1977	BENDIX	2	48	10		X254153	X254154
		07.1969	07.1977	GIRL-TRW	3	34/48	10		X374437	X374438
		06.1975	07.1977	GIRL-TRW	2	48	10		X374275	X374276

205

CTI / GTI		02.1983	09.1998	BENDIX	1	48	20,4		X254013	X254014
		02.1983	09.1998	GIRL-TRW	1	48	20		X374007	X374008
		02.1983	09.1998	BENDIX	1	30	8		X255007	X255008
Tout / All / Alle / Tutti / Todos		02.1983	09.1998	ATE	1	48	20		X224247	X224248
		02.1983	09.1998	BENDIX	1	48	10		X254057	X254058
		02.1983	09.1998	BENDIX	1	48	10		X254087	X254088
		02.1983	09.1998	BENDIX	1	48	20,4		X254113	X254114
		02.1983	09.1998	GIRL-TRW	1	48	10		X374003	X374004
TURBO 16		01.1983	09.1998	BENDIX	1	54	20,4		X254043	X254044
		02.1983	09.1998	BENDIX	1	50	20,5		X255025	X255026

206 (RC)

2.0 RC		07.2003	03.2009	BOSCH	1	54	26		X274039	X274040
		07.2003	03.2009	BENDIX	1	32	8		X255033	X255034

Affectations par Marques

Vehicule application - Zuordnung nach Marke und Fahrzeuge - Applicazione per marca e veicolo - Aplicacion por marca y vehiculo



PEUGEOT

206 / 206 CC / 206 SW

Tout / All / Alle / Tutti / Todos		09.1998	03.2009	BOSCH	1	48	10/Ø247	#ID: 359893 359894	X274005	X274006
		09.1998	03.2009	BOSCH	1	48	13/Ø247	#ID: 359653 359654	X274007	X274008
		09.1998	03.2009	BOSCH	1	48	13/Ø247	#ID: Y01210 Y01211	X274025	X274026
		09.1998	03.2009	BOSCH	1	48	20,4/Ø247	#ID: 359803 359804	X274009	X274010
		09.1998	03.2009	BOSCH	1	48	20,4/Ø247	#ID: Y01213 Y01214	X274027	X274028
		09.1998	03.2009	BOSCH	1	54	20,4/Ø266	#ID: 361053 361054	X274011	X274012
		09.1998	03.2009	BOSCH	1	54	20,4/Ø266	#ID: Y01216 Y01217	X274029	X274030
		09.1998	03.2009	BOSCH	1	54	22/Ø266	#ID: Y01131 Y01132	X274023	X274024
		09.1998	03.2009	BENDIX	1	30	8		X255007	X255008

206 +

Tout / All / Alle / Tutti / Todos		01.2009	06.2013	BOSCH	1	48	13/Ø247		X274025	X274026
		01.2009	06.2013	BOSCH	1	48	20,4/Ø247		X274027	X274028

207 / 207 CC / 207 SW

Tout / All / Alle / Tutti / Todos		02.2006		BOSCH	1	54	22/Ø266		X274023	X274024
		02.2006		BOSCH	1	54	26/Ø283		X274039	X274040
		02.2007		ATE	1	57	26		X224655	X224656
		02.2006		BOSCH	1	38	9		X275041	X275042
		04.2007		GIRL-TRW	1	38	9		X375347	X375348

208

Tout / All / Alle / Tutti / Todos		03.2012		ATE	1	57	26		X224759	X224760
		03.2012		BOSCH	1	54	22		X274023	X274024
		03.2012		GIRL-TRW	1	38	9		X375347	X375348

301

Tout / All / Alle / Tutti / Todos		11.2012		BOSCH	1	54	22		X274023	X274024
-----------------------------------	--	---------	--	-------	---	----	----	--	---------	---------

304

Tout / All / Alle / Tutti / Todos		09.1969	05.1975	GIRL-TRW	2	48	10		X374311	X374312
		03.1972	07.1977	BENDIX	2	48	10		X254153	X254154
		06.1975	08.1977	GIRL-TRW	2	48	10		X374275	X374276
		07.1977	02.1978	BENDIX	1	48	10		X254187	X254188
		10.1977	12.1981	ATE	1	48	10		X224107	X224108
		02.1978	12.1981	BENDIX	1	48	10		X254083	X254084

305

Tout / All / Alle / Tutti / Todos		01.1977	09.1982	ATE	1	48	9		X224107	X224108
		07.1977	07.1982	BENDIX	1	48	10		X254083	X254084
		08.1982	12.1989	BENDIX	1	48	10		X254057	X254058
		07.1985	12.1987	BENDIX	1	48	20,4		X254013	X254014

306

2.0 S16		03.1996	12.1997	GIRL-TRW	1	54	20		X374255	X374256
		03.1996	05.2001	GIRL-TRW	1	57	22		X374411	X374412
		06.1994	05.2001	BENDIX	1	30	8		X255007	X255008
		03.1996	05.2001	BENDIX	1	32	8		X255033	X255034

X=1 : SNRA - X=2 : EAI - X=3 : SERA - X=4 : SEEAC - X=5 : NEOTO - X=6 : STARTCAR

Affectations par Marques

Vehicule application - Zuordnung nach Marke und Fahrzeuge - Applicazione per marca e veicolo - Aplicacion por marca y vehiculo



PEUGEOT

306

Tout / All / Alle / Tutti / Todos		05.1993	10.2003	ATE	1	48	20		X224247	X224248
		05.1993	10.2003	BENDIX	1	48	10		X254131	X254132
		05.1993	10.2003	BOSCH	1	48	10/Ø247		X274005	X274006
		06.1996	10.2003	BOSCH	1	54	20,4		X274011	X274012
		05.1997	10.2003	BOSCH	1	48	13/Ø247		X274007	X274008
		05.1997	10.2003	GIRL-TRW	1	54	20,4/Ø266		X374405	X374406
		05.1993	06.1997	BENDIX	1	30	8		X255007	X255008
		07.1997	10.2003	BENDIX	1	32	8		X255033	X255034

307 / 307CC / 307 SW

Tout / All / Alle / Tutti / Todos		08.2000		ATE	1	57	26		X224655	X224656
		08.2000		BOSCH	1	54	22/Ø266		X274023	X274024
		08.2000		BOSCH	1	54	26/Ø283		X274039	X274040
		08.2000		BOSCH	1	38	9		X275025	X275026
		08.2000		GIRL-TRW	1	38	9		X375267	X375268

308 I / 308 I CC

1.6 GTi		07.2010	10.2014	ATE	1	60	30		X224903	X224904
		07.2010	10.2014	GIRL-TRW	1	38	12		X375457	X375458
1.6 THP		10.2010	12.2014	ATE	1	60	30		X224903	X224904
		10.2010	12.2014	GIRL-TRW	1	38	12		X375457	X375458
Tout / All / Alle / Tutti / Todos		09.2007		ATE	1	57	26	#ID: 765 766	X224655	X224656
		09.2007		ATE	1	57	26	#ID: 939 940	X224759	X224760
		09.2007		BOSCH	1	57	26		X274091	X274092
		09.2007		GIRL-TRW	1	38	9		X375267	X375268

308 I SW

Tout / All / Alle / Tutti / Todos		09.2007		ATE	1	57	26	#ID: 765 766	X224655	X224656
		09.2007		ATE	1	57	26	#ID: 939 940	X224759	X224760
		09.2007		BOSCH	1	57	26		X274091	X274092
		09.2007		GIRL-TRW	1	38	12	#ID: 028 / B	X375359	X375360
		09.2007		GIRL-TRW	1	38	9	#ID: 712 / 760 713 / 761	X375267	X375268

308 II / 308 II SW

Tout / All / Alle / Tutti / Todos		09.2013		ATE	1	60	28		X224889	X224890
		09.2013		BOSCH	1	57	26		X274121	X274122
		09.2013		MANDO	1	57	22		X484085	X484086
		09.2013		ATE	1	38	10		X225443	X225444
		09.2013		BOSCH	1	38	10		X277001	X277002

309

Tout / All / Alle / Tutti / Todos		09.1985	09.1989	BENDIX	1	48	10		X254057	X254058
		09.1985	12.1993	BENDIX	1	48	20,5		X254013	X254014
		09.1985	12.1993	GIRL-TRW	1	48	10		X374003	X374004
		09.1985	12.1993	GIRL-TRW	1	48	20,5		X374007	X374008
		10.1989	12.1993	BENDIX	1	48	10		X254087	X254088
		09.1985	12.1993	BENDIX	1	30	8		X255007	X255008

X=1 : SNRA - X=2 : EAI - X=3 : SERA - X=4 : SEEAC - X=5 : NEOTO - X=6 : STARTCAR

Affectations par Marques

Vehicule application - Zuordnung nach Marke und Fahrzeuge - Applicazione per marca e veicolo - Aplicacion por marca y vehiculo



PEUGEOT

405

Tout / All / Alle / Tutti / Todos		01.1987	11.1999	BENDIX	1	48	10	#ID: 32943_ / 32839_	X254087	X254088
		01.1987	11.1999	BENDIX	1	48	10	#ID: 34973_	X254131	X254132
		01.1987	11.1999	BENDIX	1	48	20,5		X254013	X254014
		01.1987	11.1999	GIRL-TRW	1	48	20/Ø266		X374279	X374280
		01.1987	11.1999	GIRL-TRW	1	54	20,5/Ø266		X374257	X374258
		01.1987	11.1999	GIRL-TRW	1	57	22Ø283	4x4	X374235	X374236
		01.1987	11.1999	GIRL-TRW	1	38	10	4x4	X375031	X375032
		01.1987	11.1999	GIRL-TRW	1	38	10		X375041	X375042

406

Tout / All / Alle / Tutti / Todos		11.1995	12.2004	BREMBO	4	38/42	26		X284015	X284016
		11.1995	12.2004	GIRL-TRW	1	57	24/Ø260		X374379	X374380
		11.1995	12.2004	GIRL-TRW	1	57	26/Ø283		X374381	X374382
		11.1995	12.2004	ATE	1	33	10		X225159	X225160

407

Tout / All / Alle / Tutti / Todos		05.2004	04.2011	ATE	1	60	28		X224751	X224752
		05.2004	04.2011	GIRL-TRW	1	57	26		X374597	X374598
		05.2004	04.2011	GIRL-TRW	2	40/45	30		X374599	X374600
		05.2004	04.2011	GIRL-TRW	1	38	12		X375333	X375334

504

Tout / All / Alle / Tutti / Todos		07.1968	03.1975	GIRL-TRW	2	54	12,7		X374315	X374316
		04.1975	04.1979	GIRL-TRW	2	54	12,7		X374333	X374334
		10.1977	12.1984	ATE	1	54	12,7		X224109	X224110
		10.1977	12.1984	ATE	1	54	20		X224145	X224146
		10.1977	12.1984	GIRL-TRW	2	54	12,7		X374039	X374040
		10.1977	12.1984	GIRL-TRW	2	54	20		X374339	X374340
		05.1979	12.1984	GIRL-TRW	2	54	12,7		X374039	X374040
		07.1968	12.1970	GIRL-TRW	2	43	10		X375097	X375098
		01.1971	02.1975	GIRL-TRW	2	43	10		X375099	X375100
		03.1975	05.1979	GIRL-TRW	2	43	10		X375015	X375016
		06.1979	12.1984	GIRL-TRW	2	43	10		X375017	X375018

505

Tout / All / Alle / Tutti / Todos		05.1979	12.1993	ATE	1	54	12,7		X224109	X224110
		05.1979	12.1993	ATE	1	54	20		X224145	X224146
		05.1979	12.1993	BENDIX	1	54	12,7		X254011	X254012
		05.1979	12.1993	GIRL-TRW	2	54	12,7	->1010805	X374039	X374040
		05.1979	12.1993	GIRL-TRW	2	54	12,7	1010806->	X374333	X374334
		08.1979	12.1993	GIRL-TRW	2	43	10	->1010805	X375015	X375016
		08.1979	12.1993	GIRL-TRW	2	43	10	1010806->	X375017	X375018

Affectations par Marques

Vehicule application - Zuordnung nach Marke und Fahrzeuge - Applicazione per marca e veicolo - Aplicacion por marca y vehiculo



PEUGEOT

508

Tout / All / Alle / Tutti / Todos		11.2010		ATE	1	60	26/Ø283		X224919	X224920
		11.2010		ATE	1	60	28/Ø304		X224911	X224912
		11.2010		ATE	1	60	30/Ø340		X224903	X224904
		11.2010		ATE	1	38	12		X225447	X225448
		11.2010		GIRL-TRW	1	38	12		X375459	X375460

604

Tout / All / Alle / Tutti / Todos		08.1977	07.1987	ATE	1	54	12,7		X224109	X224110
		08.1977	07.1987	ATE	1	54	20		X224145	X224146
		08.1977	03.1979	GIRL-TRW	2	43	10		X375015	X375016
		04.1979	07.1987	GIRL-TRW	2	43	10		X375017	X375018

605

2.5 SRDT/SVDT		06.1989	09.1999	BENDIX	1	57	26/Ø283		X254163	X254164
3.0 V6		06.1989	09.1999	ATE	1	57	28		X224227	X224228
		06.1989	09.1999	BOSCH	1	57			X274097	X274098
Tout / All / Alle / Tutti / Todos		06.1989	02.1991	BENDIX	1	57	22/Ø276		X254115	X254116
		03.1991	09.1999	BENDIX	1	57	26/Ø283		X254117	X254118
		06.1989	09.1999	ATE	1	33	10		X225087	X225088

607

Tout / All / Alle / Tutti / Todos		05.2000	07.2011	BREMBO	4	38/42	32		X284199	X284200
		05.2000	07.2011	GIRL-TRW	1	57	26		X374381	X374382
		05.2000	07.2011	GIRL-TRW	2	40/45	30		X374599	X374600
		05.2000	07.2011	ATE	1	33	10		X225087	X225088
		05.2000	07.2011	GIRL-TRW	1	38	12		X375353	X375354

806

Tout / All / Alle / Tutti / Todos		06.1994	08.2002	BENDIX	1	57	20		X254207	X254208
		06.1994	08.2002	GIRL-TRW	1	57	26		X374293	X374294
		06.1994	08.2002	ATE	1	36	10		X225161	X225162

807

Tout / All / Alle / Tutti / Todos		06.2002		BREMBO	4	40/44	32		X284113	X284114
		06.2002		GIRL-TRW	1	60	28		X374589	X374590
		06.2002		GIRL-TRW	2	40/45	32		X374699	X374700
		06.2002		GIRL-TRW	1	38	12		X375291	X375292

1007

1.4		04.2005	12.2010	BOSCH	1	54	22/Ø266		X274023	X274024
1.4 16V		10.2005	12.2008	BOSCH	1	54	22/Ø266		X274023	X274024
1.4 HDi		04.2005	12.2010	BOSCH	1	54	22/Ø266		X274023	X274024
1.6 16V		04.2005	12.2010	BOSCH	1	54	22/Ø266		X274023	X274024
1.6 HDi		06.2007	12.2010	BOSCH	1	54	26/Ø283		X274039	X274040
Tout / All / Alle / Tutti / Todos		04.2005	12.2010	GIRL-TRW	1	38	9		X375347	X375348

Affectations par Marques

Vehicule application - Zuordnung nach Marke und Fahrzeuge - Applicazione per marca e veicolo - Aplicacion por marca y vehiculo



PEUGEOT

2008

Tout / All / Alle / Tutti / Todos		03.2013		BOSCH	1	54	22/Ø266		X274023	X274024
		03.2013		BOSCH	1	54	26/Ø283		X274095	X274096
		03.2013		GIRL-TRW	1	38	9		X375347	X375348

3008

1.6 HDi		06.2009		BOSCH	1	57	26		X274091	X274092
		06.2009		GIRL-TRW	1	38	12		X375457	X375458
1.6 THP		06.2009		ATE	1	57	26		X224759	X224760
		06.2009		GIRL-TRW	1	38	12		X375457	X375458
1.6 VTi		06.2009		BOSCH	1	57	26		X274091	X274092
		06.2009		GIRL-TRW	1	38	12		X375457	X375458
2.0 HDi		06.2009		ATE	1	57	26		X224759	X224760
		06.2009		GIRL-TRW	1	38	12		X375457	X375458
2.0 HDi Hybrid4		02.2011		ATE	1	60	26		X224765	X224766
		02.2011		GIRL-TRW	1	38	12		X375459	X375460

4007

Tout / All / Alle / Tutti / Todos		02.2007		AKE	2	43	24		X164207	X164208
		02.2007		AKE	1	38	12		X165167	X165168

4008

Tout / All / Alle / Tutti / Todos		05.2012		AKE	1	57	26		X164317	X164318
-----------------------------------	--	---------	--	-----	---	----	----	--	---------	---------

5008

Tout / All / Alle / Tutti / Todos		06.2009		ATE	1	60	26		X224765	X224766
		06.2009		GIRL-TRW	1	38	12		X375459	X375460

BIPPER / BIPPER Tepee

Tout / All / Alle / Tutti / Todos		02.2008		BOSCH	1	54	22/Ø257		X274071	X274072
-----------------------------------	--	---------	--	-------	---	----	---------	--	---------	---------

BOXER I (230/230L)

Tout / All / Alle / Tutti / Todos		03.1994	04.2002	GIRL-TRW	2	40/48	18		ABS	X374223	X374224
		03.1994	04.2002	GIRL-TRW	2	40/48	18		ABS	X374225	X374226
		03.1994	04.2002	GIRL-TRW	2	40/48	24		ABS	X374227	X374228
		03.1994	04.2002	GIRL-TRW	2	40/48	24		ABS	X374229	X374230
		03.1994	04.2002	GIRL-TRW	2	45/48	24		ABS	X374231	X374232
		03.1994	04.2002	GIRL-TRW	2	45/48	24		ABS	X374233	X374234

BOXER II (244, Z_)

Tout / All / Alle / Tutti / Todos		12.2001	06.2006	BREMBO	2	44/48	24/Ø280	ABS		->1400	X284045	X284046
		12.2001	06.2006	BREMBO	2	44/48	24/Ø280	ABS		->1400	X284047	X284048
		12.2001	06.2006	BREMBO	2	46/52	24/Ø300	ABS		->1800	X284029	X284030
		12.2001	06.2006	BREMBO	2	46/52	24/Ø300	ABS		->1800	X284049	X284050
		12.2001	06.2006	BREMBO	1	46	16				X285031	X285032

Affectations par Marques

Vehicule application - Zuordnung nach Marke und Fahrzeuge - Applicazione per marca e veicolo - Aplicacion por marca y vehiculo



PEUGEOT

BOXER III

Tout / All / Alle / Tutti / Todos		04.2006		BREMBO	2	44/48	24/Ø280		X284093	X284094	
		04.2006		BREMBO	2	46/52	24/Ø300		X284095	X284096	
		04.2006		BREMBO	2	46/52	28/Ø280		X284117	X284118	
		04.2006		BREMBO	2	46/52	32/Ø300		X284097	X284098	
		04.2006		BOSCH	1	48	16		Avec capteur de plaquette	X275081	X275082
		04.2006		BOSCH	1	48	16		Sans capteur de plaquette	X275051	X275052

EXPERT I (222, 223, 224)

Tout / All / Alle / Tutti / Todos		10.1995	12.2006	BENDIX	1	57	20			X254207	X254208
		10.1995	12.2006	GIRL-TRW	1	57	26		#ID: 479_	X374293	X374294
		10.2003	12.2006	GIRL-TRW	1	60	28		#ID: 806_	X374589	X374590

EXPERT II

Tout / All / Alle / Tutti / Todos		01.2007		GIRL-TRW	2	45/48	28/Ø304			X374663	X374664
		01.2007		GIRL-TRW	2	45/58	28/Ø280			X374661	X374662
		01.2007		GIRL-TRW	1	41	14			X375341	X375342

J5 (280/290)

Tout / All / Alle / Tutti / Todos		09.1981	02.1984	GIRL-TRW	2	38/48	13			X374011	X374012
		09.1981	03.1994	GIRL-TRW	2	43/48	16/Ø290			X374159	X374160
		03.1984	03.1994	GIRL-TRW	2	38/48	16/Ø256			X374013	X374014

J7/J9

Tout / All / Alle / Tutti / Todos		08.1968	05.1985	BENDIX	2	48	14			X254155	X254156
		06.1985	06.1987	BENDIX	2	48	14			X254165	X254166

PARTNER I

Tout / All / Alle / Tutti / Todos		04.1996	07.2011	BOSCH	1	54	22/Ø266			X274023	X274024
		04.1996	07.2011	BOSCH	1	54	26/Ø283			X274039	X274040
		04.1996	07.2011	GIRL-TRW	1	54	13/Ø266			X374403	X374404
		04.1996	07.2011	GIRL-TRW	1	54	20,4/Ø266			X374405	X374406
		04.1996	07.2011	GIRL-TRW	1	38	9			X375295	X375296

PARTNER II / PARTNER Tepee

Tout / All / Alle / Tutti / Todos		04.2008		ATE	1	60	26/Ø302			X224765	X224766
		04.2008		BOSCH	1	54	22/Ø266			X274023	X274024
		04.2008		BOSCH	1	54	26/Ø283			X274039	X274040
		04.2008		GIRL-TRW	1	38	12			X375403	X375404

RCZ

Tout / All / Alle / Tutti / Todos		03.2010		ATE	1	57	26/Ø302			X224759	X224760
		03.2010		ATE	1	60	30/Ø340			X224903	X224904
		03.2010		GIRL-TRW	1	38	12/Ø268			X375457	X375458

PLYMOUTH

BARRACUDA

Tout / All / Alle / Tutti / Todos		01.1964	12.1969	K/H	4	41				X794065	X794066
-----------------------------------	--	---------	---------	-----	---	----	--	--	--	---------	---------

X=1 : SNRA - X=2 : EAI - X=3 : SERA - X=4 : SEEAC - X=5 : NEOTO - X=6 : STARTCAR

Affectations par Marques

Vehicule application - Zuordnung nach Marke und Fahrzeuge - Applicazione per marca e veicolo - Aplicacion por marca y vehiculo



PONCIN

PONCIN

Tout / All / Alle / Tutti / Todos				BENDIX	1	45			X255071	X255072
-----------------------------------	--	--	--	--------	---	----	--	--	---------	---------

PONTIAC

6000

2.8		01.1990	12.1991	K/H	1	63,5	27		X794045	X794046
-----	--	---------	---------	-----	---	------	----	--	---------	---------

FIERO

Tout / All / Alle / Tutti / Todos		01.1984	12.1987	K/H	1	49			X794063	X794064
		01.1984	12.1987	K/H	1	48			X795013	X795014
		01.1988	12.1988	K/H	1	48			X795015	X795016

FIREBIRD

Tout / All / Alle / Tutti / Todos		01.1970	12.1976	K/H	1	74,6			X794005	X794006
		01.1977	12.1981	K/H	1	74,6			X794003	X794004
		01.1982	12.1993	K/H	1	63,5			X794031	X794032
		01.1979	12.1981	K/H	1	63,5			X795029	X795030
		01.1993	12.1997	PBR	1	40,5			X595007	X595008

GRAND AM

Tout / All / Alle / Tutti / Todos		01.1969	12.1972	K/H	1	74,6			X794053	X794054
-----------------------------------	--	---------	---------	-----	---	------	--	--	---------	---------

GRAND PRIX

Tout / All / Alle / Tutti / Todos		01.1992	12.1993	K/H	1	35	13		X795005	X795006
-----------------------------------	--	---------	---------	-----	---	----	----	--	---------	---------

TRANS SPORT

Tout / All / Alle / Tutti / Todos		01.1992	12.1993	K/H	1	63,5	32		X794021	X794022
		01.1993		K/H	1	63,5	32		X794029	X794030
		01.1994	12.1996	K/H	1	63,5	32		X794017	X794018

PORSCHE

356

356		01.1963	12.1965	ATE	4	33			X224641	X224642
		01.1963	12.1965	ATE	4	25			X225327	X225328
356 C - SC		01.1963	12.1965	ATE	2	48			X224509	X224510
		01.1963	12.1965	ATE	2	35			X225203	X225204

904

Tout / All / Alle / Tutti / Todos		01.1964	12.1965	ATE	2	38			X225257	X225258
-----------------------------------	--	---------	---------	-----	---	----	--	--	---------	---------

906

Tout / All / Alle / Tutti / Todos		01.1966	01.1967	ATE	2	38			X225257	X225258
-----------------------------------	--	---------	---------	-----	---	----	--	--	---------	---------

910

Tout / All / Alle / Tutti / Todos		01.1966	01.1967	ATE	2	48			X224561	X224562
		01.1966	01.1967	ATE	2	48			X225259	X225260

911

2.0		08.1968	02.1972	ATE	2	48	20,4		X224307	X224308
		08.1968	02.1972	ATE	2	38	20		X225121	X225122

X=1 : SNRA - X=2 : EAI - X=3 : SERA - X=4 : SEEAC - X=5 : NEOTO - X=6 : STARTCAR

Affectations par Marques

Vehicule application - Zuordnung nach Marke und Fahrzeuge - Applicazione per marca e veicolo - Aplicacion por marca y vehiculo



PORSCHE



911											
3.0		08.1980	07.1983	ATE	2	48	20,4			X224297	X224298
		08.1980	07.1983	ATE	2	38	20			X225121	X225122
3.1		08.1983	08.1989	ATE	2	48	20,4			X224407	X224408
		08.1983	08.1989	ATE	2	42	20			X225123	X225124
3.2		08.1983	08.1989	ATE	2	48	20,4			X224407	X224408
		08.1983	08.1989	ATE	2	42	20			X225123	X225124

911 Targa											
Tout / All / Alle / Tutti / Todos		06.1967		ATE	2	48	20,4			X224307	X224308

912											
Tout / All / Alle / Tutti / Todos		01.1964	01.1969	ATE	2	48	12			X224535	X224536
		01.1964	01.1969	ATE	2	35	10			X225235	X225236
		01.1964	01.1969	ATE	2	38	10			X225237	X225238

914											
Tout / All / Alle / Tutti / Todos		01.1969	12.1973	ATE	2	42	10,5			X224377	X224378
		01.1969	12.1973	ATE	2	42	11			X224063	X224064
		01.1969	12.1973	ATE	2	48	20,4			X224307	X224308
		01.1969	12.1973	ATE	2	33	9,5			X225137	X225138
		01.1969	12.1973	ATE	2	38	10,5			X225147	X225148

924											
2.0		11.1975	08.1989	ATE	1	48	13			X224409	X224410
2.0 Carrera GT		06.1980	07.1981	ATE	1	54	20,5			X224411	X224412
2.0 Turbo		11.1978	10.1986	ATE	1	54	20,5			X224411	X224412
2.5 S		09.1985	07.1988	ATE	1	54	20,5			X224411	X224412
Tout / All / Alle / Tutti / Todos		11.1975	08.1989	ATE	1	36	20			X225129	X225130

928											
4.5		09.1977	08.1982	ATE	1	54	20			X224413	X224414
4.7 S		09.1979	07.1982	ATE	1	54	20			X224413	X224414
		08.1982	12.1985	ATE	1	54	20			X224415	X224416
5.0 S		09.1984	12.1985	ATE	1	54	20			X224415	X224416
Tout / All / Alle / Tutti / Todos		09.1977	12.1985	ATE	1	36	20			X225155	X225156

930											
Tout / All / Alle / Tutti / Todos		01.1978	12.1989	BREMBO	4	38				X284111	X284112
		01.1978	12.1989	BREMBO	4	30				X285057	X285058

944											
944		06.1981	07.1991	ATE	1	54	20,5			X224411	X224412
		06.1981	07.1991	ATE	1	36	20			X225129	X225130
944 S		08.1985	07.1991	BREMBO	4	^{36/40}	28			X284053	X284054
944 TURBO		08.1985	07.1991	BREMBO	4	^{36/40}	28			X284017	X284018
		08.1985	07.1991	BREMBO	4	^{28/30}	24			X285007	X285008

Affectations par Marques

Vehicule application - Zuordnung nach Marke und Fahrzeuge - Applicazione per marca e veicolo - Aplicacion por marca y vehiculo



PORSCHE



1600

Tout / All / Alle / Tutti / Todos		01.1963	12.1965	ATE	2	48			X224509	X224510
		01.1963	12.1965	ATE	2	35			X225203	X225204



RELIANT



CARMEL

Tout / All / Alle / Tutti / Todos		01.1963	12.1964	GIRL-TRW	2	43			X374307	X374308
-----------------------------------	--	---------	---------	----------	---	----	--	--	---------	---------

SABRE 4

Tout / All / Alle / Tutti / Todos		01.1961	12.1965	GIRL-TRW	2	48			X374487	X374488
-----------------------------------	--	---------	---------	----------	---	----	--	--	---------	---------

SABRE SPORTS

Tout / All / Alle / Tutti / Todos		01.1965	12.1965	GIRL-TRW	2	48			X374487	X374488
-----------------------------------	--	---------	---------	----------	---	----	--	--	---------	---------



RENAULT



4

Tout / All / Alle / Tutti / Todos		06.1978	06.1990	BENDIX	1	45	10		X254001	X254002
		06.1978	06.1990	GIRL-TRW	1	45	10		X374107	X374108

5

Alpine Turbo		10.1981	03.1985	BENDIX	1	48	10		X254031	X254032
		10.1981	03.1985	GIRL-TRW	1	48	10		X374261	X374262
		10.1981	03.1985	BENDIX	1	36	10		X255009	X255010
Turbo		06.1980	03.1985	BENDIX	1	54	20		X254041	X254042
		06.1980	03.1985	BENDIX	1	54	20		X255011	X255012
Tout / All / Alle / Tutti / Todos		01.1972	12.1985	BENDIX	1	45	10		X254001	X254002
		01.1972	12.1985	GIRL-TRW	1	45	10		X374107	X374108
		01.1972	12.1985	GIRL-TRW	1	48	10		X374261	X374262

8

Tout / All / Alle / Tutti / Todos		01.1962	12.1972	BENDIX	1	38	6,6		X254151	X254152
		01.1962	12.1972	BENDIX	1	32	6,6		X255041	X255042

9

Tout / All / Alle / Tutti / Todos		09.1981	02.1997	BENDIX	1	48	12	#ID: 21610_	X254157	X254158
		09.1981	02.1997	BENDIX	1	48	12	#ID: 33123_	X254003	X254004
		09.1981	02.1997	GIRL-TRW	1	48	12		X374029	X374030
		09.1981	02.1997	GIRL-TRW	1	48	20,5		X374007	X374008
		09.1981	02.1997	BENDIX	1	30			X255007	X255008

10

Tout / All / Alle / Tutti / Todos		11.1962	01.1972	BENDIX	1	38	6,6		X254151	X254152
		11.1962	01.1972	BENDIX	1	32	6,6		X255041	X255042

11

1.4 Turbo		03.1983	12.1988	GIRL-TRW	1	48	20,5		X374007	X374008
		02.1984	06.1986	BENDIX	1	30			X255007	X255008

X=1 : SNRA - X=2 : EAI - X=3 : SERA - X=4 : SEEAC - X=5 : NEOTO - X=6 : STARTCAR

Affectations par Marques

Vehicule application - Zuordnung nach Marke und Fahrzeuge - Applicazione per marca e veicolo - Aplicacion por marca y vehiculo



RENAULT

11

Tout / All / Alle / Tutti / Todos		01.1983	06.1983	BENDIX	1	48	12	#ID: 21610_	X254157	X254158
		01.1983	12.1988	BENDIX	1	48	12	#ID: 33123_	X254003	X254004
		01.1983	12.1988	BENDIX	1	48	12	#ID: 33667_ / 21613_	X254119	X254120
		03.1983	12.1988	GIRL-TRW	1	48	12		X374029	X374030

12

GORDINI		10.1970	12.1980	BENDIX	1	54	20		X254037	X254038
		10.1970	12.1980	BENDIX	1	36	10		X255009	X255010
Tout / All / Alle / Tutti / Todos		01.1969	12.1980	BENDIX	1	48	10		X254031	X254032
		01.1969	12.1980	BENDIX	1	48	10		X254075	X254076
		01.1969	12.1980	GIRL-TRW	1	48	10		X374261	X374262

14

Tout / All / Alle / Tutti / Todos		05.1976	12.1983	ATE	1	48	10		X224125	X224126
		05.1976	12.1983	BENDIX	1	48	10		X254071	X254072

15

Tout / All / Alle / Tutti / Todos		07.1971	12.1979	BENDIX	1	48	10		X254031	X254032
		07.1971	12.1979	BENDIX	1	54	20		X254037	X254038

16

Tout / All / Alle / Tutti / Todos		02.1965	09.1968	BENDIX	1	48	9		X254175	X254176
		10.1968	12.1980	BENDIX	1	48	12		X254179	X254180
		01.1969	12.1973	GIRL-TRW	2	48	12		X374329	X374330
		10.1973	06.1975	BENDIX	1	54	12		X254193	X254194

17

Tout / All / Alle / Tutti / Todos		10.1971	12.1979	BENDIX	1	54	20		X254037	X254038
		10.1971	12.1979	BENDIX	1	36	10		X255009	X255010

18

Tout / All / Alle / Tutti / Todos		04.1978	12.1986	BENDIX	1	48	10		X254075	X254076
		04.1978	12.1986	BENDIX	1	48	10		X254255	X254256
		04.1978	12.1986	BENDIX	1	48	12		X254007	X254008
		04.1978	12.1986	BENDIX	1	48	12		X254171	X254172
		04.1978	12.1986	BENDIX	1	54	20		X254009	X254010
		04.1978	12.1986	GIRL-TRW	1	48	10		X374079	X374080
		04.1978	12.1986	GIRL-TRW	1	48	12		X374025	X374026
		04.1978	12.1986	GIRL-TRW	1	54	20		X374009	X374010
		04.1978	12.1986	BENDIX	1	36	10		X255015	X255016

19

Tout / All / Alle / Tutti / Todos		01.1988	08.2003	BENDIX	1	48	12		X254119	X254120
		01.1988	08.2003	GIRL-TRW	1	48	12		X374029	X374030
		01.1988	08.2003	GIRL-TRW	1	48	20,5		X374007	X374008
		01.1988	08.2003	BENDIX	1	30	8		X255007	X255008

Affectations par Marques

Vehicule application - Zuordnung nach Marke und Fahrzeuge - Applicazione per marca e veicolo - Aplicacion por marca y vehiculo



RENAULT

20

Tout / All / Alle / Tutti / Todos		10.1975	12.1983	BENDIX	1	54	20		X254009	X254010
		10.1975	10.1980	BENDIX	1	54	20/Ø238		X254061	X254062
		10.1975	12.1983	BENDIX	1	54	24/Ø252		X254073	X254074
		10.1975	12.1983	GIRL-TRW	1	54	20		X374009	X374010

21

Tout / All / Alle / Tutti / Todos		03.1986	07.1997	BENDIX	1	48	12	#ID: 21610_	X254157	X254158
		03.1986	07.1997	BENDIX	1	48	12	#ID: 33123_	X254003	X254004
		03.1986	07.1997	BENDIX	1	54	20,5		X254035	X254036
		03.1986	07.1997	GIRL-TRW	1	48	12		X374029	X374030
		03.1986	07.1997	GIRL-TRW	1	48	20,5		X374007	X374008
		03.1986	07.1997	BENDIX	1	36	12		X255047	X255048
		03.1986	07.1997	BREMBO	1	36	8		X285001	X285002

25

Tout / All / Alle / Tutti / Todos		04.1984	12.1993	GIRL-TRW	1	54	20/Ø259		X374009	X374010
		04.1984	12.1993	GIRL-TRW	1	60	22/Ø280		X374047	X374048
		04.1984	12.1993	BENDIX	1	36	10		X255015	X255016

30

2.1 Turbo-D (1270)		02.1982	01.1984	GIRL-TRW	1	54	20		X374009	X374010
		05.1979	07.1986	BENDIX	1	36	10		X255015	X255016
2.6 (1273)		08.1976	08.1978	BENDIX	2	42	24		X254063	X254064
		05.1979	07.1986	BENDIX	1	36	10		X255015	X255016

AVANTIME

Tout / All / Alle / Tutti / Todos		09.2001	05.2003	GIRL-TRW	2	40/45	28		X374453	X374454
		09.2001	05.2003	GIRL-TRW	1	38	10		X375245	X375246

B 70/80/90/110/120

Tout / All / Alle / Tutti / Todos		10.1982	12.1992	BENDIX	2	52	16		X254141	X254142
		10.1982	12.1992	BENDIX	2	52	16		X254251	X254252

CAPTUR

Tout / All / Alle / Tutti / Todos		06.2013		ATE	1	54	24		X224817	X224818
		06.2013		GIRL-TRW	1	54	22		X374631	X374632

CARAVELLE

Tout / All / Alle / Tutti / Todos		11.1962	12.1968	BENDIX	1	38	6,6		X254151	X254152
		11.1962	12.1968	BENDIX	1	32	6,6		X255041	X255042

CLIO I

Tout / All / Alle / Tutti / Todos		05.1990	09.1998	BENDIX	1	45	8		X254015	X254016
		05.1990	09.1998	BENDIX	1	48	12		X254119	X254120
		05.1990	09.1998	GIRL-TRW	1	48	12		X374029	X374030
		05.1990	09.1998	GIRL-TRW	1	48	20,5		X374007	X374008
		05.1990	09.1998	BENDIX	1	30	8		X255007	X255008

Affectations par Marques

Vehicule application - Zuordnung nach Marke und Fahrzeuge - Applicazione per marca e veicolo - Aplicacion por marca y vehiculo



RENAULT

CLIO II

2.0 16V SPORT		09.1998	05.2005	GIRL-TRW	1	54	24		X374625	X374626
		09.1998	07.2006	BENDIX	1	30	8		X255051	X255052
Tout / All / Alle / Tutti / Todos		09.1998	05.2005	GIRL-TRW	1	48	12		X374029	X374030
		09.1998	05.2005	GIRL-TRW	1	48	20,5		X374007	X374008

CLIO III

2.0 16V SPORT (200)		05.2005	12.2012	BREMBO	4	40	28		X284127	X284128
		05.2005	12.2012	GIRL-TRW	1	38	10		X375355	X375356
Tout / All / Alle / Tutti / Todos		05.2005	12.2012	GIRL-TRW	1	54	22		X374631	X374632
		05.2005	12.2012	GIRL-TRW	1	34	8		X375343	X375344

CLIO IV

Tout / All / Alle / Tutti / Todos		11.2012		ATE	1	48	22		X224877	X224878
		11.2012		GIRL-TRW	1	54	22		X374631	X374632

DAUPHINE

Tout / All / Alle / Tutti / Todos		11.1962	03.1967	BENDIX	1	38	6,6		X254151	X254152
		11.1962	03.1967	BENDIX	1	32	6,6		X255041	X255042

DUSTER (HS_)

Tout / All / Alle / Tutti / Todos		02.2012		ATE	1	54	24		X224817	X224818
		02.2012		GIRL-TRW	1	54	22		X374631	X374632

ENCORE

Tout / All / Alle / Tutti / Todos		01.1984	12.1986	K/H	1	48			X794077	X794078
-----------------------------------	--	---------	---------	-----	---	----	--	--	---------	---------

ESPACE I

Tout / All / Alle / Tutti / Todos		07.1984	12.1990	BENDIX	1	54	20		X254009	X254010
		07.1984	12.1990	GIRL-TRW	1	54	20		X374009	X374010
		07.1984	12.1990	BENDIX	1	36	10	4x4	X255049	X255050
		07.1984	12.1990	BENDIX	1	36	10		X255015	X255016

ESPACE II

2.2 4x4 (J/S637, J63G)		03.1991	12.1996	GIRL-TRW	1	54	20		X374009	X374010
		03.1991	12.1996	BENDIX	1	36	10		X255049	X255050
2.8 V6 (J638, J63J)		01.1991	10.1996	GIRL-TRW	1	60	22		X374047	X374048
		01.1991	10.1996	BENDIX	1	36	10		X255015	X255016
Tout / All / Alle / Tutti / Todos		01.1991	10.1996	GIRL-TRW	1	54	20		X374009	X374010
		01.1991	10.1996	BENDIX	1	36	10		X255015	X255016

ESPACE III

1.9 dTi (JE0M)		02.1999	08.2001	GIRL-TRW	1	54	22		X374367	X374368
2.0		11.1996	10.2002	GIRL-TRW	1	54	22		X374367	X374368
2.0 16V (JE0N, JE0L, JE02)		10.1998	10.2002	GIRL-TRW	1	54	22		X374367	X374368
2.2 12V TD (JE0E, JE0H, JE0P)		11.1996	10.2000	GIRL-TRW	1	60	24		X374369	X374370
2.2 D		11.1997	09.1999	GIRL-TRW	1	60	24		X374369	X374370
2.2 dCi (JE0K, JE0S)		07.2000	10.2002	GIRL-TRW	2	40/45	28		X374453	X374454
3.0 (JE0D)		11.1996	10.1998	GIRL-TRW	1	60	24		X374369	X374370
3.0 V6 24V (JE0G, JE0R)		10.1998	12.2001	GIRL-TRW	2	40/45	28		X374507	X374508

X=1 : SNRA - X=2 : EAI - X=3 : SERA - X=4 : SEEC - X=5 : NEOTO - X=6 : STARTCAR

Affectations par Marques

Vehicule application - Zuordnung nach Marke und Fahrzeuge - Applicazione per marca e veicolo - Aplicacion por marca y vehiculo



RENAULT

ESPACE III

Tout / All / Alle / Tutti / Todos		11.1996	10.2002	BREMBO	1	36	10		X285005	X285006
		11.1996	10.2002	GIRL-TRW	1	38	10		X375245	X375246

ESPACE IV

Tout / All / Alle / Tutti / Todos		11.2002		ATE	1	60	28		X224563	X224564
		11.2002		ATE	1	38	11		X225245	X225246

EXPRESS

Tout / All / Alle / Tutti / Todos		02.1986	10.1999	BENDIX	1	45	8		X254015	X254016
		02.1986	10.1999	BENDIX	1	48	12	#ID: 33123_	X254003	X254004
		02.1986	10.1999	BENDIX	1	48	12	#ID: 33667_ / 21613_	X254119	X254120
		02.1986	10.1999	GIRL-TRW	1	45	8		X374027	X374028
		02.1986	10.1999	GIRL-TRW	1	48	12		X374029	X374030

FLORIDE

Tout / All / Alle / Tutti / Todos		11.1962	12.1968	BENDIX	1	38	6,6		X254151	X254152
		11.1962	12.1968	BENDIX	1	32	6,6		X255041	X255042

FLUENCE

Z.E		02.2012		ATE	1	54	24		X224817	X224818
		02.2012		GIRL-TRW	1	38	10		X375355	X375356
Tout / All / Alle / Tutti / Todos		02.2010		ATE	1	54	24		X224817	X224818
		02.2010		GIRL-TRW	1	34	8		X375281	X375282
		07.2014		GIRL-TRW	1	34	11		X377011	X377012

FUEGO

Tout / All / Alle / Tutti / Todos		02.1980	10.1985	BENDIX	1	48	12		X254007	X254008
		02.1980	10.1985	BENDIX	1	48	20		X254009	X254010
		02.1980	10.1985	GIRL-TRW	1	48	12		X374025	X374026
		02.1980	10.1985	GIRL-TRW	1	54	20		X374009	X374010
		02.1980	10.1985	BENDIX	1	36	10		X255015	X255016

GRAND SCÉNIC II

Tout / All / Alle / Tutti / Todos		04.2004	01.2009	ATE	1	54	24/Ø280		X224647	X224648
		04.2004	01.2009	ATE	1	54	24/Ø300		X224711	X224712
		04.2004	01.2009	BOSCH	1	54	24		X274053	X274054
		04.2004	01.2009	GIRL-TRW	1	38	10	#ID: 948 949	X375395	X375396
		04.2004	01.2009	GIRL-TRW	1	38	10	#ID: 9944 9945	X375355	X375356

GRAND SCÉNIC III

1.5 dCi (86)		04.2009	11.2011	ATE	1	54	24		X224817	X224818
		02.2009	11.2011	GIRL-TRW	1	38	11		X377009	X377010
		04.2009	11.2011	GIRL-TRW	1	34	11		X377011	X377012
		04.2009	11.2011	GIRL-TRW	1	34	8		X375281	X375282
Tout / All / Alle / Tutti / Todos		02.2009	08.2016	ATE	1	57	26		X224821	X224822
		02.2009	08.2016	GIRL-TRW	1	38	10		X375355	X375356
		02.2009	08.2016	GIRL-TRW	1	38	11		X377009	X377010

Affectations par Marques

Vehicule application - Zuordnung nach Marke und Fahrzeuge - Applicazione per marca e veicolo - Aplicacion por marca y vehiculo



RENAULT

KADJAR

Tout / All / Alle / Tutti / Todos		06.2015		AKE	1	57	26		X164333	X164334
		06.2015		GIRL-TRW	1	36	13		X377055	X377056

KANGOO I

Tout / All / Alle / Tutti / Todos		08.1997	09.2013	BOSCH	1	54	20	ABS	X274003	X274004
		08.1997	09.2013	BOSCH	1	54	24	ABS	X274075	X274076
		08.1997	09.2013	BOSCH	1	38	12		X275027	X275028

KANGOO II

Tout / All / Alle / Tutti / Todos		02.2008		GIRL-TRW	1	54	22/Ø260		X374631	X374632
		02.2008		GIRL-TRW	1	54	24/Ø280		X374667	X374668
		02.2008		GIRL-TRW	1	38	11/Ø275		X375439	X375440

KOLEOS I

Tout / All / Alle / Tutti / Todos		09.2008	08.2016	NISSAN	2	45	28		X554057	X554058
		09.2008	08.2016	AKE	1	43	16		X165191	X165192

LAGUNA I

Tout / All / Alle / Tutti / Todos		11.1993	03.2001	GIRL-TRW	1	48	22/Ø262	ABS	X374365	X374366
		11.1993	03.2001	GIRL-TRW	1	54	22/Ø262	ABS	X374367	X374368
		11.1993	03.2001	GIRL-TRW	1	54	24/Ø280	ABS	X374625	X374626
		11.1993	03.2001	GIRL-TRW	1	60	24/Ø280	ABS	X374369	X374370
		11.1993	03.2001	BREMBO	1	36	10	ABS	X285005	X285006
		11.1993	03.2001	BREMBO	1	36	11	ABS	X285011	X285012

LAGUNA I Nevada

Tout / All / Alle / Tutti / Todos		09.1995	03.2001	GIRL-TRW	1	54	22/Ø262		X374367	X374368
		09.1995	03.2001	GIRL-TRW	1	54	24/Ø280		X374625	X374626
		09.1999	03.2001	GIRL-TRW	1	60	24/Ø280		X374369	X374370
		09.1995	03.2001	BREMBO	1	36	10	ABS	X285005	X285006
		09.1995	03.2001	BREMBO	1	36	11	ABS	X285011	X285012

LAGUNA II

Tout / All / Alle / Tutti / Todos		03.2001	12.2007	ATE	1	57	24/Ø280		X224617	X224618
		03.2001	12.2007	ATE	1	57	26/Ø300		X224591	X224592
		03.2001	12.2007	ATE	1	60	28/Ø324		X224563	X224564
		03.2001	12.2007	ATE	1	38	11		X225245	X225246

LAGUNA III

Tout / All / Alle / Tutti / Todos		10.2007		ATE	1	57	26/Ø296		X224821	X224822
		10.2007		ATE	1	57	28/Ø320		X224915	X224916
		10.2007		ATE	1	38	11		X225427	X225428

LATITUDE

Tout / All / Alle / Tutti / Todos		07.2010		ATE	1	57	26		X224821	X224822
-----------------------------------	--	---------	--	-----	---	----	----	--	---------	---------

LOGAN I (LS_)

Tout / All / Alle / Tutti / Todos		09.2004	10.2013	GIRL-TRW	1	48	12		X374029	X374030
		09.2004	10.2013	GIRL-TRW	1	48	20,5		X374007	X374008

Affectations par Marques

Vehicule application - Zuordnung nach Marke und Fahrzeuge - Applicazione per marca e veicolo - Aplicacion por marca y vehiculo



RENAULT

LOGAN I BREAK (KS_)

Tout / All / Alle / Tutti / Todos		04.2007		ATE	1	54	22		X224847	X224848
		04.2007		GIRL-TRW	1	48	12		X374029	X374030
		04.2007		GIRL-TRW	1	48	20,5/Ø247		X374007	X374008
		04.2007		GIRL-TRW	1	54	22/Ø260		X374631	X374632

LOGAN I EXPRESS (US_)

Tout / All / Alle / Tutti / Todos		04.2007	08.2012	ATE	1	54	22		X224847	X224848
		04.2007	08.2012	GIRL-TRW	1	54	22		X374631	X374632

LOGAN II (B8_)

Tout / All / Alle / Tutti / Todos		12.2013		ATE	1	48	22		X224877	X224878
-----------------------------------	--	---------	--	-----	---	----	----	--	---------	---------

LOGAN II Break (K8_)

Tout / All / Alle / Tutti / Todos		12.2013		ATE	1	48	22		X224877	X224878
-----------------------------------	--	---------	--	-----	---	----	----	--	---------	---------

MASCOTT

Tout / All / Alle / Tutti / Todos		01.1999	12.2010	BREMBO	2	44	22		X284041	X284042
		01.1999	12.2010	BREMBO	2	52	26		X284043	X284044
		01.1999	12.2010	BREMBO	2	44	22	#ID: 777604 777605	X285037	X285038
		01.1999	12.2010	BREMBO	2	46	22	#ID: 730705 730707	X285029	X285030

MASTER I (P_, T_)

Tout / All / Alle / Tutti / Todos		08.1980	07.1998	BENDIX	2	52	16		X254141	X254142
		08.1980	07.1998	BENDIX	2	52	16		X254251	X254252
		08.1980	07.1998	GIRL-TRW	4	48	24		X374173	X374174
		08.1980	07.1998	GIRL-TRW	4	48	24		X374421	X374422

MASTER II (ED/FD/HD/JD/UD)

3.0 dCi		07.1998	05.2010	BREMBO	2	44	22		X284041	X284042
		07.1998	05.2010	BREMBO	2	52	26		X284043	X284044
		07.1998	05.2010	BREMBO	2	44	22/Ø289		X285037	X285038
		07.1998	05.2010	BREMBO	2	46	22		X285029	X285030
Tout / All / Alle / Tutti / Todos		07.1998	05.2010	BOSCH	2	45	24	ABS	X274049	X274050
		07.1998	05.2010	BOSCH	2	45	28	ABS	X274051	X274052
		07.1998	05.2010	BOSCH	2	45	28	ABS	X274065	X274066
		07.1998	05.2010	BOSCH	1	42	12		X275023	X275024

MASTER III (EV,FV, HV,JV, UV)

2.3 dCi		02.2010		BREMBO	2	48	28		X284171	X284172
		02.2010		BREMBO	1	48	12		X285069	X285070
		02.2010		BREMBO	1	60	12		X285081	X285082

MAXITY

Tout / All / Alle / Tutti / Todos		03.2007		BREMBO	2	48	26		X284181	X284182
		03.2007		BREMBO	1	46			X285047	X285048

Affectations par Marques

Vehicule application - Zuordnung nach Marke und Fahrzeuge - Applicazione per marca e veicolo - Aplicacion por marca y vehiculo



RENAULT

MEGANE I

Tout / All / Alle / Tutti / Todos		01.1996	08.2003	GIRL-TRW	1	48	12		X374029	X374030
		01.1996	08.2003	GIRL-TRW	1	48	20,5/Ø247 -259		X374007	X374008
		01.1996	08.2003	GIRL-TRW	1	54	22/Ø262		X374367	X374368
		01.1996	08.2003	GIRL-TRW	1	54	24/Ø280		X374625	X374626
		01.1996	08.2003	BENDIX	1	30	8		X255051	X255052
		01.1996	08.2003	GIRL-TRW	1	34	11		X375217	X375218

MEGANE I Scenic

Tout / All / Alle / Tutti / Todos		10.1996	12.2001	GIRL-TRW	1	48	20,5/Ø247 -259		X374007	X374008
		10.1996	12.2001	GIRL-TRW	1	54	22/Ø262		X374367	X374368
		10.1996	12.2001	GIRL-TRW	1	54	24/Ø280		X374625	X374626
		10.1996	12.2001	GIRL-TRW	1	34	11		X375217	X375218

MEGANE II

2.0 16V TURBO/ 2.0 SPORT		05.2004	12.2009	BREMBO	4	40	28		X284127	X284128
		05.2004	12.2009	ATE	1	38	11		X225245	X225246
		05.2004	12.2009	GIRL-TRW	1	38	10		X375355	X375356
Tout / All / Alle / Tutti / Todos		11.2002	12.2009	ATE	1	54	24		X224647	X224648
		11.2002	12.2009	BOSCH	1	54	22/Ø260		X274055	X274056
		11.2002	12.2009	BOSCH	1	54	24/Ø300		X274053	X274054
		11.2002	12.2009	GIRL-TRW	1	34	8		X375281	X375282

MEGANE III

Tout / All / Alle / Tutti / Todos		11.2008		ATE	1	54	24/Ø280		X224817	X224818
		11.2008		ATE	1	57	27/Ø296		X224821	X224822
		11.2008		BREMBO	4	40	28		X284219	X284220
		11.2008		GIRL-TRW	1	34	11		X377011	X377012
		11.2008		GIRL-TRW	1	34	8/Ø240		X375281	X375282
		11.2008		GIRL-TRW	1	38	10/Ø270		X375355	X375356

MODUS / GRAND MODUS (F/JPO_)

Tout / All / Alle / Tutti / Todos		09.2004	12.2012	GIRL-TRW	1	54	22		X374631	X374632
		09.2004	12.2012	GIRL-TRW	1	34	8		X375343	X375344

SAFRANE I

3.0		12.1992	07.1996	GIRL-TRW	1	60	24		X374369	X374370
		04.1992	07.1996	BREMBO	1	36	9,5		X285003	X285004
3.0 4x4		12.1992	07.1996	GIRL-TRW	1	60	24		X374369	X374370
		04.1992	07.1996	BENDIX	1	36	10		X255055	X255056
Tout / All / Alle / Tutti / Todos		12.1992	07.1996	GIRL-TRW	1	54	22		X374367	X374368
		04.1992	07.1996	BREMBO	1	36	9,5		X285003	X285004

SAFRANE II

2.0 16V (B54L)		07.1996	12.2000	GIRL-TRW	1	54	22/Ø262		X374367	X374368
		07.1996	12.2000	GIRL-TRW	1	60	24/Ø280		X374369	X374370
		02.1998	12.2000	GIRL-TRW	1	54	24/Ø280		X374625	X374626
		07.1996	12.2000	BENDIX	1	36	10		X255055	X255056
		07.1996	12.2000	BREMBO	1	36	9,5		X285003	X285004

X=1 : SNRA - X=2 : EAI - X=3 : SERA - X=4 : SEEC - X=5 : NEOTO - X=6 : STARTCAR

Affectations par Marques

Vehicule application - Zuordnung nach Marke und Fahrzeuge - Applicazione per marca e veicolo - Aplicacion por marca y vehiculo



RENAULT

SAFRANE II

Tout / All / Alle / Tutti / Todos		07.1996	12.2000	GIRL-TRW	1	54	22/Ø262		X374367	X374368
		07.1996	12.2000	GIRL-TRW	1	60	24/Ø280		X374369	X374370
		07.1996	12.2000	BENDIX	1	36	10		X255055	X255056
		07.1996	12.2000	BREMBO	1	36	9,5		X285003	X285004

SANDERO/STEPWAY I

1.4 / 1.6		02.2009	07.2013	GIRL-TRW	1	48	12		X374029	X374030
		02.2009	07.2013	GIRL-TRW	1	48	20		X374007	X374008

SANDERO/STEPWAY II

1.5 dCi		12.2013		ATE	1	48	22		X224877	X224878
---------	--	---------	--	-----	---	----	----	--	---------	---------

SCÉNIC I

1.9 dCi RX4 / 2.0 16V RX4		09.1999	03.2002	ATE	1	57	26		X224591	X224592
		04.2002	08.2003	GIRL-TRW	1	54	24		X374625	X374626
		11.2000	08.2003	GIRL-TRW	1	34	11		X375385	X375386
Tout / All / Alle / Tutti / Todos		09.1999	09.2003	GIRL-TRW	1	54	22/Ø262		X374367	X374368
		09.1999	09.2003	GIRL-TRW	1	54	24/Ø280		X374625	X374626
		09.1999	09.2003	GIRL-TRW	1	34	11		X375217	X375218

SCÉNIC II

Tout / All / Alle / Tutti / Todos		06.2003	12.2009	ATE	1	54	24/Ø280		X224647	X224648
		06.2003	12.2009	ATE	1	54	24/Ø300		X224711	X224712
		06.2003	12.2009	BOSCH	1	54	24/Ø300		X274053	X274054
		06.2003	12.2009	GIRL-TRW	1	34	10/Ø270		X375445	X375446
		06.2003	12.2009	GIRL-TRW	1	34	8/Ø240		X375281	X375282

SCÉNIC III

Tout / All / Alle / Tutti / Todos		02.2009		ATE	1	54	24		X224817	X224818
		02.2009		ATE	1	57	26	" icon"/>	X224821	X224822
		02.2009		GIRL-TRW	1	34	11		X377011	X377012
		02.2009		GIRL-TRW	1	34	8/Ø240		X375281	X375282
		02.2009		GIRL-TRW	1	38	10/Ø270		X375355	X375356
		02.2009		GIRL-TRW	1	38	11		X377009	X377010

SUPER 5

1.4 Turbo / GT (C405)		10.1984	12.1996	GIRL-TRW	1	48	20,5		X374007	X374008
		10.1984	12.1996	BENDIX	1	30	8		X255007	X255008
Tout / All / Alle / Tutti / Todos		10.1984	12.1996	BENDIX	1	45	8/Ø238		X254015	X254016
		10.1984	12.1996	BENDIX	1	48	12/Ø238	#ID: 33123_	X254003	X254004
		10.1984	12.1996	BENDIX	1	48	12/Ø238	#ID: 33667_ / 21613_	X254119	X254120
		10.1984	12.1996	GIRL-TRW	1	45	8		X374027	X374028
		10.1984	12.1996	GIRL-TRW	1	48	12		X374029	X374030
		10.1984	12.1996	GIRL-TRW	1	48	20,5		X374007	X374008

SYMBOLE I / II

Tout / All / Alle / Tutti / Todos		08.2000	06.2014	GIRL-TRW	1	48	12/Ø238 ~247		X374029	X374030
		08.2000	06.2014	GIRL-TRW	1	48	20,5/Ø247 ~259		X374007	X374008

X=1 : SNRA - X=2 : EAI - X=3 : SERA - X=4 : SEEAC - X=5 : NEOTO - X=6 : STARTCAR

Affectations par Marques

Vehicule application - Zuordnung nach Marke und Fahrzeuge - Applicazione per marca e veicolo - Aplicacion por marca y vehiculo



RENAULT

THALIA I / II

Tout / All / Alle / Tutti / Todos		08.2000	06.2014	GIRL-TRW	1	48	12/Ø238 ~247		X374029	X374030
		08.2000	06.2014	GIRL-TRW	1	48	20,5/Ø247 ~259		X374007	X374008

TRAFIC I

Tout / All / Alle / Tutti / Todos		03.1980	03.2001	BENDIX	1	54	24		X254073	X254074
		03.1980	06.1984	BENDIX	2	42	24		X254063	X254064
		07.1984	03.2001	BENDIX	2	45	24		X254039	X254040

TRAFIC II

Tout / All / Alle / Tutti / Todos		03.2001	04.2014	GIRL-TRW	2	40/45	28		X374453	X374454
		03.2001	04.2014	GIRL-TRW	1	41	12		X375197	X375198

TWINGO I

Tout / All / Alle / Tutti / Todos		03.1993	06.2012	BENDIX	1	45	8,2		X254147	X254148
		03.1993	06.2012	GIRL-TRW	1	48	12		X374029	X374030
		03.1993	06.2012	GIRL-TRW	1	48	20,5		X374007	X374008

TWINGO II

1.6 RS		03.2007	09.2014	ATE	1	57	28		X224915	X224916
Tout / All / Alle / Tutti / Todos		03.2007	09.2014	GIRL-TRW	1	48	12		X374029	X374030
		03.2007	09.2014	GIRL-TRW	1	48	20,5		X374007	X374008

TWINGO III

0.9 Tce 90		09.2014		ATE	1	48	22		X224877	X224878
1.0 SCE 71		09.2014		ATE	1	48	22		X224877	X224878

VEL SATIS

Tout / All / Alle / Tutti / Todos		06.2002	12.2010	ATE	1	60	28/Ø324		X224563	X224564
		06.2002	12.2010	ATE	1	38	11		X225245	X225246

WIND (E4M_)

Tout / All / Alle / Tutti / Todos		07.2010		ATE	1	57	28		X224915	X224916
		07.2010		GIRL-TRW	1	34	8/Ø240		X375281	X375282

ZOE

Tout / All / Alle / Tutti / Todos		06.2012		GIRL-TRW	1	54	22		X374631	X374632
-----------------------------------	--	---------	--	----------	---	----	----	--	---------	---------

ROLLS-ROYCE

CAMARGUE

Tout / All / Alle / Tutti / Todos		08.1973		GIRL-TRW	2	54			X374459	X374460
		08.1973		GIRL-TRW	4	40/48			X375177	X375178

CORNICHE

Tout / All / Alle / Tutti / Todos		09.1970	08.1973	GIRL-TRW	2	54			X374451	X374452
		08.1973	12.1974	GIRL-TRW	2	54			X374459	X374460
		09.1970	08.1973	GIRL-TRW	4	40/48			X375183	X375184
		08.1973	12.1974	GIRL-TRW	4	40/48			X375177	X375178

Affectations par Marques

Vehicule application - Zuordnung nach Marke und Fahrzeuge - Applicazione per marca e veicolo - Aplicacion por marca y vehiculo



ROLLS-ROYCE

SILVER SHADOW

Tout / All / Alle / Tutti / Todos		09.1965	08.1973	GIRL-TRW	2	54			X374451	X374452
		08.1973	12.1976	GIRL-TRW	2	54			X374459	X374460
		09.1965	08.1973	GIRL-TRW	4	40/48			X375183	X375184
		08.1973	12.1976	GIRL-TRW	4	40/48			X375177	X375178

SILVER SPUR (LHM)

Tout / All / Alle / Tutti / Todos		01.1980	12.1998	GIRL-TRW	2	54			X374655	X374656
		01.1980	12.1998	GIRL-TRW	4	40			X375327	X375328
				GIRL-TRW	4	40			X375205	X375206

ROVER

25 (RF)

Tout / All / Alle / Tutti / Todos		09.1999	05.2005	GIRL-TRW	1	54	13		X374447	X374448
		09.1999	05.2005	GIRL-TRW	1	30	10		X375081	X375082

45 (RT)

Tout / All / Alle / Tutti / Todos		02.2000	05.2005	GIRL-TRW	1	54	13		X374447	X374448
		02.2000	05.2005	GIRL-TRW	1	54	21		X374167	X374168
		02.2000	05.2005	GIRL-TRW	1	30	10		X375081	X375082

75 (RJ)

Tout / All / Alle / Tutti / Todos		02.1999	05.2005	ATE	1	57	22/Ø284		X224547	X224548
		02.1999	05.2005	ATE	1	57	25/Ø325		X224555	X224556
		02.1999	05.2005	ATE	1	36	10		X225107	X225108
		02.1999	05.2005	ATE	1	40	19		X225209	X225210

100 / METRO (XP)

Tout / All / Alle / Tutti / Todos		03.1990	12.1998	GIRL-TRW	1	48	13		X374285	X374286
		03.1990	12.1998	GIRL-TRW	1	48	22		X374287	X374288

200 I (XH)

213 / 216		03.1985	09.1989	TOKICO	1	51	17		X674001	X674002
		09.1985	09.1989	TOKICO	1	51	12		X674019	X674020

200 II (XW)











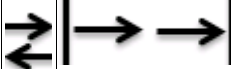























Tout / All / Alle / Tutti / Todos		10.1989	06.1999	GIRL-TRW	1	54	13/Ø238		X374215	X374216
		10.1989	06.1999	GIRL-TRW	1	54	13/Ø265		X374447	X374448
		10.1989	06.1999	GIRL-TRW	1	54	21		X374167	X374168
		10.1989	06.1999	GIRL-TRW	1	30	10		X375081	X375082

200 III (RF)

Tout / All / Alle / Tutti / Todos		11.1995	03.2000	GIRL-TRW	1	54	13		X374447	X374448
		11.1995	03.2000	GIRL-TRW	1	54	21		X374167	X374168
		11.1995	03.2000	GIRL-TRW	1	30	10		X375081	X375082

Affectations par Marques

Vehicule application - Zuordnung nach Marke und Fahrzeuge - Applicazione per marca e veicolo - Aplicacion por marca y vehiculo

								
ROVER								
400 I (XW)								
Tout / All / Alle / Tutti / Todos		01.1990	11.1998	GIRL-TRW	1	54	13/Ø238	X374215 X374216
		01.1990	11.1998	GIRL-TRW	1	54	13/Ø265	X374447 X374448
		01.1990	11.1998	GIRL-TRW	1	54	21	X374167 X374168
		01.1990	11.1998	GIRL-TRW	1	30	10	X375081 X375082
400 II (RT)								
Tout / All / Alle / Tutti / Todos		05.1995	03.2000	GIRL-TRW	1	54	13	X374447 X374448
		05.1995	03.2000	GIRL-TRW	1	54	21	X374167 X374168
		05.1995	03.2000	GIRL-TRW	1	30	10	X375081 X375082
600 (RH)								
Tout / All / Alle / Tutti / Todos		08.1993	02.1999	GIRL-TRW	1	57	23	X374371 X374372
		08.1993	02.1999	GIRL-TRW	1	57	23	X374373 X374374
		08.1993	02.1999	GIRL-TRW	1	34	10	X375095 X375096
800								
Tout / All / Alle / Tutti / Todos		07.1986	02.1999	GIRL-TRW	1	57	21/Ø262	X374201 X374202
		07.1986	02.1999	GIRL-TRW	1	57	21/Ø285	X374237 X374238
		07.1986	02.1999	GIRL-TRW	1	38	10	X375053 X375054
2000-3500 I (P6)								
2000-3500 (P6)-2200(TC)		09.1963	05.1976	GIRL-TRW	2	54	12,7	X374349 X374350
		09.1963	05.1976	GIRL-TRW			9,5	X375113 X375114
3500		04.1968	05.1976	GIRL-TRW	3	40/57	12,7	X374321 X374322
2000-3500 II (SD1)								
Tout / All / Alle / Tutti / Todos		06.1976	10.1986	LOCK	4	41	20	X464033 X464034
CABRIOLET (XW)								
Tout / All / Alle / Tutti / Todos		04.1990	11.1999	GIRL-TRW	1	54	13/Ø238	X374215 X374216
		04.1990	11.1999	GIRL-TRW	1	54	13/Ø265	X374447 X374448
		04.1990	11.1999	GIRL-TRW	1	54	21	X374167 X374168
		04.1990	11.1999	GIRL-TRW	1	30	10	X375081 X375082
CITYROVER								
1.4 Elegance		09.2003	12.2005	GIRL-TRW	1	54	20/Ø231	X374783 X374784
COUPE								
Tout / All / Alle / Tutti / Todos		03.1996	11.1999	GIRL-TRW	1	54	13	X374447 X374448
		03.1996	11.1999	GIRL-TRW	1	54	21	X374167 X374168
		03.1996	11.1999	GIRL-TRW	1	30	10	X375081 X375082
MINI								
Tout / All / Alle / Tutti / Todos		01.1991	05.2001	LOCK	2	51	9,5	X464025 X464026
STREETWISE								
Tout / All / Alle / Tutti / Todos		08.2003	05.2005	GIRL-TRW	1	54	13	X374447 X374448
		08.2003	05.2005	GIRL-TRW	1	54	21	X374167 X374168
		08.2003	05.2005	GIRL-TRW	1	30	10	X375081 X375082

X=1 : SNRA - X=2 : EAI - X=3 : SERA - X=4 : SEEAC - X=5 : NEOTO - X=6 : STARTCAR

Affectations par Marques

Vehicule application - Zuordnung nach Marke und Fahrzeuge - Applicazione per marca e veicolo - Aplicacion por marca y vehiculo



SAAB



90											
2.0		08.1984	07.1987	GIRL-TRW	2	54	12,7			X374075	X374076
		08.1984	07.1987	ATE	2	30	10,5			X225029	X225030
95											
Tout / All / Alle / Tutti / Todos		10.1965	07.1977	LOCK	1	51	9,5			X464009	X464010
99											
Tout / All / Alle / Tutti / Todos		01.1968	05.1986	ATE	2	48	10,5			X224009	X224010
		01.1968	05.1986	GIRL-TRW	2	54	12,7			X374075	X374076
		01.1968	05.1986	GIRL-TRW	2	54	20			X374413	X374414
		01.1968	05.1986	ATE	2	27	10,5			X225005	X225006
		01.1968	05.1986	ATE	2	30	10,5			X225029	X225030
		01.1968	05.1986	GIRL-TRW	2	27	10,5			X375013	X375014
900 I											
Tout / All / Alle / Tutti / Todos		06.1978	12.1993	GIRL-TRW	1	54	23,5			X374069	X374070
		06.1978	12.1993	GIRL-TRW	2	54	12,7			X374075	X374076
		06.1978	12.1993	GIRL-TRW	2	54	20			X374413	X374414
		06.1978	12.1993	ATE	1	33	9			X225011	X225012
		06.1978	12.1993	ATE	2	30	10,5			X225029	X225030
900 II											
Tout / All / Alle / Tutti / Todos		07.1993	02.1998	ATE	1	54	24			X224275	X224276
		07.1993	02.1998	ATE	1	57	25			X224429	X224430
		07.1993	02.1998	ATE	2	35	10			X225025	X225026
		07.1993	02.1998	ATE	2	35	10			X225163	X225164
9000											
Tout / All / Alle / Tutti / Todos		09.1984	12.1998	ATE	1	57	25			X224051	X224052
		09.1984	12.1998	GIRL-TRW	1	54	23,5			X374069	X374070
		09.1984	12.1998	GIRL-TRW	1	57	22,5			X374031	X374032
		09.1984	12.1998	ATE	1	33	9			X225011	X225012
9-3 I (YS3D)											
Tout / All / Alle / Tutti / Todos		02.1998	08.2003	ATE	1	57	25			X224429	X224430
		02.1998	08.2003	ATE	1	38	10			X225269	X225270
		02.1998	08.2003	ATE	2	35	10			X225163	X225164
9-3 II (YS3F)											
Tout / All / Alle / Tutti / Todos		09.2002	02.2015	ATE	1	57	25/Ø285		#ID: 6002	X224635	X224636
		09.2002	02.2015	ATE	1	57	25/Ø285		#ID: 781 782	X224625	X224626
		09.2002	02.2015	ATE	1	57	28/Ø302			X224693	X224694
		09.2002	02.2015	ATE	1	57	28/Ø345			X224709	X224710
		09.2002	02.2015	ATE	1	60	28/Ø302			X224703	X224704
		09.2002	02.2015	ATE	1	60	28/Ø314			X224707	X224708
		09.2002	02.2015	ATE	1	38	12/Ø278			X225277	X225278
		09.2002	02.2015	ATE	1	38	20/Ø292			X225303	X225304

Affectations par Marques

Vehicule application - Zuordnung nach Marke und Fahrzeuge - Applicazione per marca e veicolo - Aplicacion por marca y vehiculo



SAAB



9-5 I (YS3E)

Tout / All / Alle / Tutti / Todos		09.1997	12.2009	ATE	1	57	25		X224429	X224430
		09.1997	12.2009	ATE	1	38	10		X225269	X225270
		09.1997	12.2009	ATE	1	40	20		X225357	X225358
		09.1997	12.2009	ATE	2	38	10		X225187	X225188

9-5 II (YS3G)

1.6 Turbo		05.2010	01.2012	BREMBO	4	40/44	30		X284145	X284146
		05.2010	01.2012	GIRL-TRW	2	42	30		X374691	X374692
		05.2010	01.2012	MANDO	1	60	30/Ø296		X484057	X484058
		05.2010	01.2012	MANDO	1	60	30/Ø321		X484059	X484060
		05.2010	01.2012	GIRL-TRW	1	41	12		X375431	X375432
		05.2010	01.2012	GIRL-TRW	1	41	23		X375423	X375424

9-3X

Tout / All / Alle / Tutti / Todos		02.2009	07.2012	ATE	1	57	25/Ø285		X224625	X224626
		02.2009	07.2012	ATE	1	57	28/Ø302		X224693	X224694
		02.2009	07.2012	ATE	1	57	28/Ø345		X224709	X224710
		02.2009	07.2012	ATE	1	38	12/Ø278		X225277	X225278
		02.2009	07.2012	ATE	1	38	20/Ø292		X225303	X225304



SANTANA



SAMURAI

Tout / All / Alle / Tutti / Todos		09.1989	12.1995	GIRL-TRW	1	48	10		X374465	X374466
-----------------------------------	--	---------	---------	----------	---	----	----	--	---------	---------



SATURN



SATURN

1.9		01.1991	12.1997	AKE	1	32	11		X165135	X165136
-----	--	---------	---------	-----	---	----	----	--	---------	---------



SEAT



ALHAMBRA I (7V8, 7V9)

Tout / All / Alle / Tutti / Todos		04.1996	03.2010	ATE	1	57	25/Ø288		X224449	X224450
		04.1996	03.2010	ATE	1	57	26/Ø300		X224559	X224560
		04.1996	03.2010	ATE	1	57	26/Ø313		X224633	X224634
		04.1996	03.2010	GIRL-TRW	1	38	10/Ø226 ~232		X375141	X375142
		04.1996	03.2010	GIRL-TRW	1	38	13,5/Ø294		X375153	X375154

ALHAMBRA II (710)

Tout / All / Alle / Tutti / Todos		06.2010		ATE	1	57	25		X224819	X224820
		06.2010		GIRL-TRW	1	38	12		X377001	X377002

Affectations par Marques

Vehicule application - Zuordnung nach Marke und Fahrzeuge - Applicazione per marca e veicolo - Aplicacion por marca y vehiculo



SEAT

ALTEA (5P1) / XL (5P5, 5P8)

Tout / All / Alle / Tutti / Todos		03.2004		ATE	1	54	22/Ø256 -280		X224455	X224456
		03.2004		ATE	1	54	25/Ø288 -312		X224619	X224620
		04.2010		BOSCH	1	38	10/Ø272		X275065	X275066
		04.2010		GIRL-TRW	1	38	10/Ø253		X375293	X375294
		04.2010		GIRL-TRW	1	38	12/Ø282		X375377	X375378
		04.2010		GIRL-TRW	1	41	12/Ø282		X375313	X375314

AROSA (6H)

1.0		05.1997	02.2000	BENDIX	1	48	10		X254241	X254242
1.4		05.1997	06.2004	BENDIX	1	48	18		X254213	X254214
1.4 16V		01.2000	06.2004	GIRL-TRW	1	54	20		X374409	X374410
1.4 TDI		01.2000	06.2004	GIRL-TRW	1	54	20		X374409	X374410
1.7 SDI		08.1997	10.2003	BENDIX	1	48	18		X254213	X254214
Tout / All / Alle / Tutti / Todos		01.2000	06.2004	GIRL-TRW	1	34	9		X375253	X375254

CORDOBA I MK1 (6K1, 6K2)

Tout / All / Alle / Tutti / Todos		02.1993	06.1999	ATE	1	48	20		X224453	X224454
		02.1993	06.1999	GIRL-TRW	1	54	20		X374037	X374038
		02.1993	06.1999	GIRL-TRW	1	54	22		X374133	X374134
		02.1993	06.1999	VW	1	48	10		X734003	X734004
		02.1993	06.1999	VW	1	48	12		X734001	X734002
		02.1993	06.1999	VW	1	48	12		X734007	X734008
		02.1993	06.1999	GIRL-TRW	1	34	9		X375253	X375254
		02.1993	06.1999	GIRL-TRW	1	34	9		X375299	X375300
		02.1993	06.1999	GIRL-TRW	1	38	10	#ID: 2728 2729	X375031	X375032
		02.1993	06.1999	GIRL-TRW	1	38	10		X375123	X375124
		02.1993	06.1999	GIRL-TRW	1	38	10		X375141	X375142

CORDOBA I MK2 (6K2)

Tout / All / Alle / Tutti / Todos		05.1999	10.2002	ATE	1	48	20		X224453	X224454
		05.1999	10.2002	GIRL-TRW	1	54	20		X374037	X374038
		05.1999	10.2002	GIRL-TRW	1	54	22		X374133	X374134
		05.1999	10.2002	VW	1	48	10		X734003	X734004
		05.1999	10.2002	VW	1	48	12		X734001	X734002
		05.1999	10.2002	VW	1	48	12		X734007	X734008
		05.1999	10.2002	GIRL-TRW	1	34	9		X375253	X375254
		05.1999	10.2002	GIRL-TRW	1	34	9		X375299	X375300
		05.1999	10.2002	GIRL-TRW	1	38	9		X375143	X375144

Affectations par Marques

Vehicule application - Zuordnung nach Marke und Fahrzeuge - Applicazione per marca e veicolo - Aplicacion por marca y vehiculo

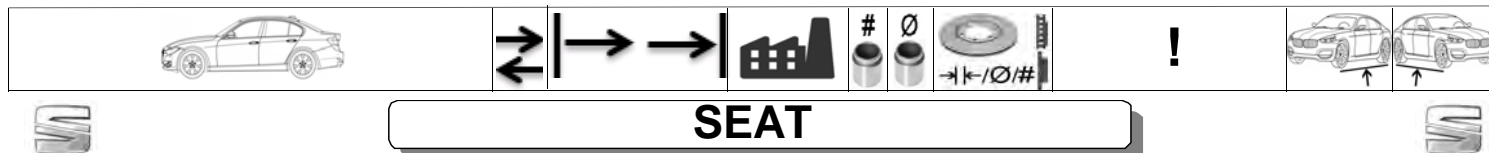

SEAT

CORDOBA I Vario (6K5)

Tout / All / Alle / Tutti / Todos		09.1996	12.2002	ATE	1	48	20		X224453	X224454
		09.1996	12.2002	GIRL-TRW	1	54	20		X374037	X374038
		09.1996	12.2002	GIRL-TRW	1	54	22		X374133	X374134
		09.1996	12.2002	VW	1	48	10		X734003	X734004
		09.1996	12.2002	VW	1	48	12		X734001	X734002
		09.1996	12.2002	VW	1	48	12		X734007	X734008
		07.1997	12.2002	GIRL-TRW	1	34	9		X375253	X375254
		07.1997	12.2002	GIRL-TRW	1	34	9		X375299	X375300
		07.1997	12.2002	GIRL-TRW	1	38	9		X375143	X375144

CORDOBA II (6L2)

Tout / All / Alle / Tutti / Todos		09.2002	11.2009	ATE	1	54	22		X224455	X224456
		09.2002	11.2009	GIRL-TRW	1	54	25		X374615	X374616
		09.2002	11.2009	GIRL-TRW	1	34	9		X375299	X375300
		09.2002	11.2009	GIRL-TRW	1	38	9		X375275	X375276

EXEO (3R2)/ ST (3R5)

Tout / All / Alle / Tutti / Todos		12.2008		ATE	1	57	25/Ø288-312		X224433	X224434
		12.2008		ATE	1	57	25/Ø288-312		X224833	X224834
		12.2008		ATE	1	60	30/Ø321		X224749	X224750
		12.2008		GIRL-TRW	1	54	22		X374435	X374436
		12.2008		GIRL-TRW	1	38	10		X375251	X375252
		12.2008		GIRL-TRW	1	41	12		X375389	X375390

FURA (025A)

0.9		01.1982	12.1986	BENDIX	1	48	11		X254033	X254034
1.4		01.1982	12.1986	BENDIX	1	48	11		X254023	X254024

IBIZA I (021A)

Tout / All / Alle / Tutti / Todos		11.1984	12.1993	BENDIX	1	48	10,8		X254085	X254086
		11.1984	12.1993	BENDIX	1	48	20		X254149	X254150

IBIZA II (6K)

Tout / All / Alle / Tutti / Todos		03.1993	02.2002	ATE	1	48	20		X224453	X224454
		03.1993	02.2002	GIRL-TRW	1	54	20		X374037	X374038
		03.1993	02.2002	GIRL-TRW	1	54	22		X374133	X374134
		03.1993	02.2002	VW	1	48	10		X734003	X734004
		03.1993	02.2002	VW	1	48	12		X734001	X734002
		03.1993	02.2002	VW	1	48	12		X734007	X734008
		03.1993	02.2002	GIRL-TRW	1	34	9		X375253	X375254
		03.1993	02.2002	GIRL-TRW	1	38	10	#ID: 2728 2729	X375031	X375032
		03.1993	02.2002	GIRL-TRW	1	38	10/Ø226-232	#ID: 443_ / 725	X375123	X375124
		03.1993	02.2002	GIRL-TRW	1	38	10/Ø226-232	#ID: 443_ / 725	X375141	X375142
		03.1993	02.2002	GIRL-TRW	1	38	9/Ø232		X375143	X375144

Affectations par Marques

Vehicule application - Zuordnung nach Marke und Fahrzeuge - Applicazione per marca e veicolo - Aplicacion por marca y vehiculo



SEAT

IBIZA III (6L)

Tout / All / Alle / Tutti / Todos		02.2002	11.2009	ATE	1	54	22/Ø256 -280		X224455	X224456
		02.2002	11.2009	ATE	1	54	25/Ø288		X224249	X224250
		02.2002	11.2009	GIRL-TRW	1	54	25		X374615	X374616
		02.2002	11.2009	GIRL-TRW	1	34	9	#ID: 736 737	X375299	X375300
		02.2002	11.2009	GIRL-TRW	1	38	9	#ID: 607 608	X375275	X375276

IBIZA IV (6J)

Tout / All / Alle / Tutti / Todos		03.2008		ATE	1	54	22/Ø256 -280		X224455	X224456
		03.2008		ATE	1	54	25/Ø288 -312		X224619	X224620
		03.2008		GIRL-TRW	1	38	9		X375275	X375276

INCA (6K)

Tout / All / Alle / Tutti / Todos		11.1995	06.2003	GIRL-TRW	1	54	13		X374037	X374038
-----------------------------------	--	---------	---------	----------	---	----	----	--	---------	---------

LEON I (1M)

Tout / All / Alle / Tutti / Todos		11.1999	06.2006	ATE	1	54	22/Ø256 -280		X224455	X224456
		11.1999	06.2006	ATE	1	54	25/Ø288 -312		X224249	X224250
		11.1999	06.2006	GIRL-TRW	1	38	22		X375255	X375256
		11.1999	06.2006	GIRL-TRW	1	38	9	Ø=3 #ID: 607 608	X375143	X375144
		11.1999	06.2006	GIRL-TRW	1	38	9	Ø=6 #ID: 607 608	X375275	X375276
		11.1999	06.2006	GIRL-TRW	1	41	9	Ø=3 #ID: 313 314	X375191	X375192
		11.1999	06.2006	GIRL-TRW	1	41	9	Ø=6 #ID: 313 314	X375193	X375194

LEON II (1P)

Tout / All / Alle / Tutti / Todos		05.2005	12.2012	ATE	1	54	22/Ø256 -280		X224455	X224456
		05.2005	12.2012	ATE	1	54	25/Ø288 -312		X224619	X224620
		05.2005	12.2012	BOSCH	1	38	10/Ø272		X275065	X275066
		05.2005	12.2012	GIRL-TRW	1	38	10/Ø253		X375293	X375294
		05.2005	12.2012	GIRL-TRW	1	38	12/Ø282		X375377	X375378

LEON III (5F)

Tout / All / Alle / Tutti / Todos		09.2012		GIRL-TRW	1	57	25/Ø288		X374777	X374778
		09.2012		GIRL-TRW	1	57	25/Ø312		X374759	X374760
		09.2012		GIRL-TRW	1	60	30/Ø340		X374781	X374782
		12.2012		GIRL-TRW	1	38	10/Ø253		X375479	X375480
		12.2012		GIRL-TRW	1	38	10/Ø272		X375477	X375478

MALAGA

Tout / All / Alle / Tutti / Todos		09.1985	12.1993	BENDIX	1	48	11		X254085	X254086
		09.1985	12.1993	BENDIX	1	48	20		X254149	X254150

MARBELLA

Tout / All / Alle / Tutti / Todos		01.1987	12.1993	BENDIX	1	48	11		X254085	X254086
-----------------------------------	--	---------	---------	--------	---	----	----	--	---------	---------

Mii (KF1_)

Tout / All / Alle / Tutti / Todos		10.2011		ATE	1	54	22/Ø256 -280		X224455	X224456
-----------------------------------	--	---------	--	-----	---	----	-----------------	--	---------	---------

RONDA (022A)

Tout / All / Alle / Tutti / Todos		06.1982	11.1988	BENDIX	1	48	11		X254085	X254086
		06.1982	11.1988	GIRL-TRW	1	48	11		X374357	X374358

X=1 : SNRA - X=2 : EAI - X=3 : SERA - X=4 : SEAC - X=5 : NEOTO - X=6 : STARTCAR

Affectations par Marques

Vehicule application - Zuordnung nach Marke und Fahrzeuge - Applicazione per marca e veicolo - Aplicacion por marca y vehiculo



SEAT

TERRA

Tout / All / Alle / Tutti / Todos		01.1987	12.1996	BENDIX	1	48	11		X254085	X254086
-----------------------------------	--	---------	---------	--------	---	----	----	--	---------	---------

TOLEDO I (1L)

Tout / All / Alle / Tutti / Todos		05.1991	03.1999	ATE	1	48	20		X224453	X224454
		05.1991	03.1999	GIRL-TRW	1	54	20		X374037	X374038
		05.1991	03.1999	VW	1	48	12		X734007	X734008
		05.1991	08.1992	GIRL-TRW	1	38	10		X375031	X375032
		09.1992	03.1999	GIRL-TRW	1	38	10		X375123	X375124

TOLEDO II (1M2)

Tout / All / Alle / Tutti / Todos		04.1999	05.2006	ATE	1	54	22/Ø256-280		X224455	X224456
		04.1999	05.2006	ATE	1	54	25/Ø288-312		X224249	X224250
		04.1999	05.2006	GIRL-TRW	1	38	9/Ø232	Ø=3 #ID: 607 608	X375143	X375144
		04.1999	05.2006	GIRL-TRW	1	38	9/Ø232	Ø=5 #ID: 607 608	X375275	X375276
		04.1999	05.2006	GIRL-TRW	1	41	9	Ø=3 #ID: 313 314	X375191	X375192
		04.1999	05.2006	GIRL-TRW	1	41	9	Ø=5 #ID: 313 314	X375193	X375194

TOLEDO III (5P2)

Tout / All / Alle / Tutti / Todos		04.2004	05.2009	ATE	1	54	22/Ø256-280		X224455	X224456
		04.2004	05.2009	ATE	1	54	25/Ø288-312		X224619	X224620
		04.2004	05.2009	GIRL-TRW	1	38	10/Ø253		X375293	X375294
		04.2004	05.2009	GIRL-TRW	1	38	12/Ø282		X375377	X375378
		04.2004	05.2009	GIRL-TRW	1	41	12/Ø282		X375313	X375314

TOLEDO IV (KG3)

Tout / All / Alle / Tutti / Todos		07.2012	06.2015	ATE	1	54	22/Ø256-280		X224455	X224456
		07.2012	06.2015	ATE	1	54	25/Ø288-312		X224619	X224620
		07.2012	06.2015	GIRL-TRW	1	38	9		X375275	X375276

SKODA

130

Tout / All / Alle / Tutti / Todos		02.1985	10.1991	PAL	4	34	9		X604001	X604002
-----------------------------------	--	---------	---------	-----	---	----	---	--	---------	---------

CITIGO

Tout / All / Alle / Tutti / Todos		10.2011		ATE	1	54	22/Ø256-280		X224455	X224456
-----------------------------------	--	---------	--	-----	---	----	-------------	--	---------	---------

FABIA I (6Y)

Tout / All / Alle / Tutti / Todos		08.1999	03.2008	ATE	1	54	22		X224455	X224456
		08.1999	03.2008	BENDIX	1	48	18		X254213	X254214
		08.1999	03.2008	GIRL-TRW	1	54	25		X374615	X374616
		08.1999	03.2008	GIRL-TRW	1	38	9		X375275	X375276

Affectations par Marques

Vehicule application - Zuordnung nach Marke und Fahrzeuge - Applicazione per marca e veicolo - Aplicacion por marca y vehiculo



SKODA



FABIA II (5J, 54_)

Tout / All / Alle / Tutti / Todos		12.2006	12.2014	ATE	1	54	22/Ø256 -280		X224455	X224456
		12.2006	12.2014	ATE	1	54	25/Ø288 -312		X224619	X224620
		12.2006	12.2014	BENDIX	1	48	18		X254213	X254214
		12.2006	12.2014	GIRL-TRW	1	54	22/Ø256		X374775	X374776
		12.2006	12.2014	GIRL-TRW	1	54	25/Ø288		X374615	X374616
		12.2006	12.2014	GIRL-TRW	1	38	9		X375275	X375276

FABIA III (NJ)

Tout / All / Alle / Tutti / Todos		08.2014		ATE	1	54	22/Ø256 -280		X224455	X224456
		08.2014		ATE	1	54	25/Ø288 -312		X224619	X224620
		08.2014		GIRL-TRW	1	38	9		X375275	X375276

FAVORIT (78_)

Tout / All / Alle / Tutti / Todos		06.1988	06.1997	GIRL-TRW	1	54	12,9		X374203	X374204
-----------------------------------	--	---------	---------	----------	---	----	------	--	---------	---------

FELICIA

Tout / All / Alle / Tutti / Todos		10.1994	04.2002	GIRL-TRW	1	54	12,9		X374203	X374204
-----------------------------------	--	---------	---------	----------	---	----	------	--	---------	---------

OCTAVIA I (1U)

Tout / All / Alle / Tutti / Todos		09.1996	12.2010	ATE	1	54	22/Ø256 -280		X224455	X224456
		09.1996	12.2010	ATE	1	54	25/Ø288 -312		X224249	X224250
		09.1996	12.2010	GIRL-TRW	1	38	9	#ID: 607 608	X375143	X375144
		09.1996	12.2010	GIRL-TRW	1	41	9	Ø=3 #ID: 313 314	X375191	X375192
		09.1996	12.2010	GIRL-TRW	1	41	9	Ø=6 #ID: 313 314	X375193	X375194

OCTAVIA II (1Z)

Tout / All / Alle / Tutti / Todos		02.2004	03.2013	ATE	1	54	22/Ø256 -280		X224455	X224456
		02.2004	03.2013	ATE	1	54	25/Ø288 -312		X224619	X224620
		02.2004	03.2013	BOSCH	1	38	10/Ø272		X275065	X275066
		02.2004	03.2013	GIRL-TRW	1	38	10/Ø253		X375293	X375294
		02.2004	03.2013	GIRL-TRW	1	38	12/Ø282		X375377	X375378
		02.2004	03.2013	GIRL-TRW	1	41	12/Ø282		X375313	X375314

OCTAVIA III (5E)

Tout / All / Alle / Tutti / Todos		11.2012		GIRL-TRW	1	57	25/Ø288		X374777	X374778
		11.2012		GIRL-TRW	1	57	25/Ø312		X374759	X374760
		11.2012		GIRL-TRW	1	60	30/Ø340		X374781	X374782
		11.2012		GIRL-TRW	1	38	10/Ø253		X375479	X375480
		11.2012		GIRL-TRW	1	38	10/Ø272		X375477	X375478

RAPID I (120G, 130G, 135G)

Tout / All / Alle / Tutti / Todos		09.1984	10.1991	PAL	4	34	9		X604001	X604002
-----------------------------------	--	---------	---------	-----	---	----	---	--	---------	---------

RAPID II (NH)

Tout / All / Alle / Tutti / Todos		07.2012		ATE	1	54	22/Ø256 -280		X224455	X224456
		07.2012		ATE	1	54	25/Ø288 -312		X224619	X224620
		07.2012		GIRL-TRW	1	38	9		X375275	X375276

Affectations par Marques

Vehicule application - Zuordnung nach Marke und Fahrzeuge - Applicazione per marca e veicolo - Aplicacion por marca y vehiculo



SKODA

ROOMSTER (5J)

Tout / All / Alle / Tutti / Todos		03.2006	05.2015	ATE	1	54	22/Ø256-280		X224455	X224456
		03.2006	05.2015	ATE	1	54	25/Ø288-312		X224619	X224620
		03.2006	05.2015	GIRL-TRW	1	54	25		X374615	X374616
		03.2006	05.2015	GIRL-TRW	1	38	9/Ø232		X375275	X375276

SUPERB I (3U)

Tout / All / Alle / Tutti / Todos		12.2001	03.2008	ATE	1	57	25/Ø288-312		X224433	X224434
		12.2001	03.2008	ATE	1	57	25/Ø288-312		X224833	X224834
		12.2001	03.2008	GIRL-TRW	1	38	10		X375165	X375166

SUPERB II (3T)

Tout / All / Alle / Tutti / Todos		03.2008	05.2015	ATE	1	54	25/Ø288-312		X224619	X224620
		03.2008	05.2015	ATE	1	57	25-30/Ø345		X224725	X224726
		03.2008	05.2015	BOSCH	1	38	10		X275065	X275066
		03.2008	05.2015	GIRL-TRW	1	41	12		X375313	X375314
		03.2008	05.2015	GIRL-TRW	1	41	22		X375379	X375380

SUPERB III (3V)

Tout / All / Alle / Tutti / Todos		03.2015		ATE	1	42	12/Ø312		PR: 1KU	X227007	X227008
-----------------------------------	--	---------	--	-----	---	----	---------	--	---------	---------	---------

YETI (5L)

Tout / All / Alle / Tutti / Todos		05.2009		ATE	1	54	22/Ø256-280		X224455	X224456
		05.2009		ATE	1	54	25/Ø288-312		X224619	X224620
		05.2009		BOSCH	1	38	10		X275065	X275066
		05.2009		GIRL-TRW	1	38	10/Ø253		X375293	X375294
		05.2009		GIRL-TRW	1	41	12/Ø282		X375313	X375314

SMART (MCC)

CABRIO (450)

Tout / All / Alle / Tutti / Todos		03.2000	01.2004	BOSCH	1	42	9		X274073	X274074
-----------------------------------	--	---------	---------	-------	---	----	---	--	---------	---------

CITY-COUPE (450)

Tout / All / Alle / Tutti / Todos		07.1998	01.2004	BOSCH	1	42	9		X274073	X274074
-----------------------------------	--	---------	---------	-------	---	----	---	--	---------	---------

CROSSBLADE (450)

0.6		06.2002	12.2003	BOSCH	1	42	9		X274073	X274074
-----	--	---------	---------	-------	---	----	---	--	---------	---------

FORFOUR (454)

1.5 BRABUS (454.034)		05.2005	06.2006	GIRL-TRW	1	54	24/Ø281		X374419	X374420
		05.2005	06.2006	GIRL-TRW	1	34	10		X375369	X375370
Tout / All / Alle / Tutti / Todos		01.2004	06.2006	GIRL-TRW	1	54	24		X374681	X374682
		01.2004	06.2006	GIRL-TRW	1	34	10		X375369	X375370

FORTWO (450)

Tout / All / Alle / Tutti / Todos		01.2004	01.2007	BOSCH	1	42	9		X274073	X274074
-----------------------------------	--	---------	---------	-------	---	----	---	--	---------	---------

FORTWO (451)

Tout / All / Alle / Tutti / Todos		01.2007		BOSCH	1	42	9		X274101	X274102
-----------------------------------	--	---------	--	-------	---	----	---	--	---------	---------

Affectations par Marques

Vehicule application - Zuordnung nach Marke und Fahrzeuge - Applicazione per marca e veicolo - Aplicacion por marca y vehiculo



SMART (MCC)

ROADSTER (452)

Tout / All / Alle / Tutti / Todos		04.2003	11.2005	BOSCH	1	42	9			X274073	X274074
-----------------------------------	--	---------	---------	-------	---	----	---	--	--	---------	---------

SSANGYONG

KORANDO (KJ)

Tout / All / Alle / Tutti / Todos		12.1996	11.2006	MANDO	1	60	28	Fe		X484037	X484038
		12.1996	11.2006	PBR	1	60	24	Al		X594001	X594002
		12.1996	11.2006	MANDO	1	43	10,5	Fe		X485017	X485018
		12.1996	11.2006	PBR	1	40		Al		X595001	X595002

MUSSO

Tout / All / Alle / Tutti / Todos		06.1996	09.2007	MANDO	1	60	28	Fe		X484037	X484038
		06.1996	09.2007	PBR	1	60	24	Al		X594001	X594002
		06.1996	09.2007	MANDO	1	43	10,5	Fe		X485017	X485018
		06.1996	09.2007	PBR	1	40		Al		X595001	X595002

REXTON I (GAB_)

Tout / All / Alle / Tutti / Todos		04.2002		MANDO	2	43				X484069	X484070
		04.2002		MANDO	1	43	10,5	Fe		X485017	X485018

RODIUS I

Tout / All / Alle / Tutti / Todos		05.2005	06.2013	MANDO	2	48	28			X484077	X484078
		05.2005	06.2013	MANDO	1	45	19,9			X485029	X485030

SUBARU

1300 - 1600 - 1800

Tout / All / Alle / Tutti / Todos		01.1980	12.1981	AKE	1	54	10			X164163	X164164
		01.1982	08.1982	AKE	1	54	12,5			X164163	X164164
		09.1982	12.1984	AKE	1	54	12,5			X164165	X164166
		01.1985	12.1985	AKE	1	54	18			X164167	X164168

1300 - 1600 - 1800 SEDAN

Tout / All / Alle / Tutti / Todos		01.1985	12.1991	AKE	1	54	18			X164109	X164110
-----------------------------------	--	---------	---------	-----	---	----	----	--	--	---------	---------

1300 - 1600 - 1800 ST CAR

Tout / All / Alle / Tutti / Todos		01.1985	12.1991	AKE	1	54	18			X164167	X164168
-----------------------------------	--	---------	---------	-----	---	----	----	--	--	---------	---------

1400 - 1600

Tout / All / Alle / Tutti / Todos		01.1972	12.1978	AKE	1	54	10			X164159	X164160
-----------------------------------	--	---------	---------	-----	---	----	----	--	--	---------	---------

1400 - 1600 W/ INDICATOR

Tout / All / Alle / Tutti / Todos		01.1972	12.1980	AKE	1	54	10			X164159	X164160
-----------------------------------	--	---------	---------	-----	---	----	----	--	--	---------	---------

ALPINE

Tout / All / Alle / Tutti / Todos		01.1963	12.1968	GIRL-TRW	2	54				X374445	X374446
-----------------------------------	--	---------	---------	----------	---	----	--	--	--	---------	---------

FORESTER I (SF)

Tout / All / Alle / Tutti / Todos		08.1997	09.2002	AKE	2	43	24			X164265	X164266
		08.1997	09.2002	AKE	1	38	10			X165161	X165162

X=1 : SNRA - X=2 : EAI - X=3 : SERA - X=4 : SEEAC - X=5 : NEOTO - X=6 : STARTCAR

Affectations par Marques

Vehicule application - Zuordnung nach Marke und Fahrzeuge - Applicazione per marca e veicolo - Aplicacion por marca y vehiculo



SUBARU

FORESTER II (SG)

Tout / All / Alle / Tutti / Todos		09.2002	12.2008	TOKICO	2	43	24		X674081	X674082
		09.2002	12.2008	AKE	1	38	10		X165161	X165162

FORESTER III (SH)

Tout / All / Alle / Tutti / Todos		01.2008		TOKICO	2	43	24		X674081	X674082
		01.2008		TOKICO	1	38	10		X675049	X675050

FORESTER IV (SJ)

2.0 D		03.2013		TOKICO	2	43	24		X674081	X674082
		03.2013		TOKICO	2	43	24		X674087	X674088
		03.2013		TOKICO	1	38	10		X675047	X675048
		03.2013		TOKICO	1	40	18		X675053	X675054
2.0 X		03.2013		TOKICO	2	43	24		X674081	X674082
		03.2013		TOKICO	1	38	10		X675047	X675048
2.0 XT		03.2013		TOKICO	2	43	24		X674087	X674088
		03.2013		TOKICO	1	40	18		X675053	X675054

IMPREZA (GC, GF, GFC)

Tout / All / Alle / Tutti / Todos		01.1992	09.2001	AKE	1	54	24		X164269	X164270
		01.1992	09.2001	AKE	1	57	24		X164277	X164278
		01.1992	09.2001	SUMITOMO	4	40	26		X644157	X644158
		01.1992	09.2001	TOKICO	1	57	24		X674063	X674064
		01.1992	09.2001	AKE	1	35	10		X165059	X165060
		01.1992	09.2001	AKE	1	38	18		X165149	X165150
		01.1992	09.2001	AKE	2	38	18		X165185	X165186

IMPREZA (GD, GG)

Tout / All / Alle / Tutti / Todos		12.2000	01.2011	AKE	1	57	24		X164277	X164278
		12.2000	01.2011	AKE	2	43	24		X164265	X164266
		12.2000	01.2011	BREMBO	4	40/46			X284193	X284194
		12.2000	01.2011	SUMITOMO	4	40	26		X644157	X644158
		12.2000	01.2011	TOKICO	2	43	24		X674081	X674082
		12.2000	01.2011	AKE	1	38	10		X165161	X165162

IMPREZA (GP)

Tout / All / Alle / Tutti / Todos		01.2012		TOKICO	2	43	24		X674081	X674082
		01.2012		TOKICO	1	38	10		X675047	X675048

IMPREZA (GR, GH, G3, GE)

Tout / All / Alle / Tutti / Todos		01.2008		TOKICO	2	43	24		X674081	X674082
		01.2008		TOKICO	1	38	10		X675049	X675050

JUSTY I (KAD)

Tout / All / Alle / Tutti / Todos		11.1984	12.1988	TOKICO	1	48	18		X674011	X674012
		11.1984	08.1996	TOKICO	1	51	18		X674073	X674074
		01.1989	08.1996	TOKICO	1	51	18		X674047	X674048

JUSTY II (JMA, MS)

1.3 4x4		10.1995	11.2003	TOKICO	1	48	17		X674061	X674062
---------	--	---------	---------	--------	---	----	----	--	---------	---------

X=1 : SNRA - X=2 : EAI - X=3 : SERA - X=4 : SEEAC - X=5 : NEOTO - X=6 : STARTCAR

Affectations par Marques

Vehicule application - Zuordnung nach Marke und Fahrzeuge - Applicazione per marca e veicolo - Aplicacion por marca y vehiculo



SUBARU

JUSTY III (3GX)

Tout / All / Alle / Tutti / Todos		09.2003	01.2007	BOSCH	1	48	17		X274059	X274060
-----------------------------------	--	---------	---------	-------	---	----	----	--	---------	---------

JUSTY IV

Tout / All / Alle / Tutti / Todos		01.2007		TOKICO	1	51	16		X674099	X674100
-----------------------------------	--	---------	--	--------	---	----	----	--	---------	---------

LEGACY I (BC)

Tout / All / Alle / Tutti / Todos		01.1989	12.1994	AKE	1	57	18		X164133	X164134
		01.1989	12.1994	AKE	1	57	24		X164277	X164278
		01.1989	12.1994	AKE	2	43	24		X164251	X164252
		01.1989	12.1994	TOKICO	1	57	24		X674063	X674064
		01.1989	12.1994	AKE	1	35	10	#ID: 1316	X165059	X165060
		01.1989	12.1994	AKE	1	38	10	#ID: 1409	X165101	X165102
		01.1989	12.1994	AKE	1	38	18		X165125	X165126

LEGACY II (BD, BG)

Tout / All / Alle / Tutti / Todos		01.1994	03.1999	AKE	1	57	24		X164277	X164278
		01.1994	03.1999	AKE	2	43	24		X164265	X164266
		01.1994	03.1999	TOKICO	1	57	24		X674063	X674064
		01.1994	03.1999	AKE	1	35	10	#ID: 1316	X165059	X165060
		01.1994	03.1999	AKE	1	38	10	#ID: 1409	X165101	X165102

LEGACY III (BE, BH)

Tout / All / Alle / Tutti / Todos		10.1998	08.2003	AKE	1	57	24		X164277	X164278
		10.1998	08.2003	AKE	2	43	24		X164265	X164266
		10.1998	08.2003	AKE	1	38	10		X165183	X165184

LEGACY IV (BL, BP, B13)

Tout / All / Alle / Tutti / Todos		09.2003		TOKICO	2	43	24		X674081	X674082
		09.2003		TOKICO	2	43	24		X674087	X674088
		09.2003		TOKICO	1	38	10		X675041	X675042
		09.2003		TOKICO	1	38	10		X675057	X675058

LEGACY V (BM, BR)

Tout / All / Alle / Tutti / Todos		06.2009		TOKICO	2	43	24		X674081	X674082
		06.2009		TOKICO	2	43	24		X674087	X674088
		06.2009		TOKICO	1	38	10		X675055	X675056
		06.2009		TOKICO	1	40	18		X675053	X675054

LEONE I/II

Tout / All / Alle / Tutti / Todos		03.1979	12.1994	AKE	1	54	18		X164167	X164168
-----------------------------------	--	---------	---------	-----	---	----	----	--	---------	---------

LIBERO (E10, E12)

Tout / All / Alle / Tutti / Todos		01.1983	02.2000	NAB	1	51			X524001	X524002
		01.1983	02.2000	TOKICO	1	48	18		X674011	X674012

MINI JUMBO

Tout / All / Alle / Tutti / Todos		08.1981	03.1992	NISSIN	1	48			X584019	X584020
		08.1981	03.1992	TOKICO	1	48	10		X674065	X674066

Affectations par Marques

Vehicule application - Zuordnung nach Marke und Fahrzeuge - Applicazione per marca e veicolo - Aplicacion por marca y vehiculo



SUBARU

OUTBACK I (BE, BH)

Tout / All / Alle / Tutti / Todos		10.2000	08.2003	AKE	2	43	24		X164265	X164266
		10.2000	08.2003	AKE	1	38	10		X165183	X165184

OUTBACK II (BL, BP)

Tout / All / Alle / Tutti / Todos		09.2003	12.2009	TOKICO	2	43	24		X674081	X674082
		09.2003	12.2009	TOKICO	2	43			X674085	X674086
		09.2003	12.2009	TOKICO	1	38	10		X675041	X675042
		09.2003	12.2009	TOKICO	1	38	10		X675057	X675058

OUTBACK III (BM, BR)

Tout / All / Alle / Tutti / Todos		09.2009		TOKICO	2	43	24		X674081	X674082
		09.2009		TOKICO	2	43	24		X674087	X674088
		09.2009		TOKICO	1	38	10		X675055	X675056
		09.2009		TOKICO	1	40	18		X675053	X675054

SVX (CX)

Tout / All / Alle / Tutti / Todos		09.1992	12.1997	AKE	1	38	10		X165101	X165102
-----------------------------------	--	---------	---------	-----	---	----	----	--	---------	---------

TRIBECA (B9)

Tout / All / Alle / Tutti / Todos		01.2005		TOKICO	2	43	24		X674087	X674088
-----------------------------------	--	---------	--	--------	---	----	----	--	---------	---------

VIVIO

Tout / All / Alle / Tutti / Todos		03.1992	04.2000	AISIN	1	51	9		X134041	X134042
-----------------------------------	--	---------	---------	-------	---	----	---	--	---------	---------

XV

Tout / All / Alle / Tutti / Todos		12.2011		TOKICO	2	43	24		X674081	X674082
		12.2011		TOKICO	1	38	10		X675047	X675048



SUZUKI



ALTO I

Tout / All / Alle / Tutti / Todos		02.1981	12.1988	TOKICO	1	51	10		X674037	X674038
-----------------------------------	--	---------	---------	--------	---	----	----	--	---------	---------

ALTO II (EC)

Tout / All / Alle / Tutti / Todos		12.1988	11.1993	TOKICO	1	51	10		X674037	X674038
-----------------------------------	--	---------	---------	--------	---	----	----	--	---------	---------

ALTO III (EF)

Tout / All / Alle / Tutti / Todos		11.1993	09.1997	GIRL-TRW	1	51	17		X374463	X374464
-----------------------------------	--	---------	---------	----------	---	----	----	--	---------	---------

ALTO IV (HA)

Tout / All / Alle / Tutti / Todos		10.1997	09.2004	GIRL-TRW	1	51	17		X374463	X374464
-----------------------------------	--	---------	---------	----------	---	----	----	--	---------	---------

ALTO V (FF)

Tout / All / Alle / Tutti / Todos		06.2002	01.2009	TOKICO	1	51	17		X674071	X674072
-----------------------------------	--	---------	---------	--------	---	----	----	--	---------	---------

ALTO VI 800 (GF)

Tout / All / Alle / Tutti / Todos		01.2009		NISSAN	1	51	20		X554063	X554064
-----------------------------------	--	---------	--	--------	---	----	----	--	---------	---------

Affectations par Marques

Vehicule application - Zuordnung nach Marke und Fahrzeuge - Applicazione per marca e veicolo - Aplicacion por marca y vehiculo



SUZUKI



BALENO (EG)

Tout / All / Alle / Tutti / Todos		01.1995	05.2002	AISIN	1	54	20		X134043	X134044
		01.1995	05.2002	AISIN	1	54	22		X134045	X134046
		01.1995	05.2002	TOKICO	1	54	20		X674075	X674076
		01.1995	05.2002	NAB	1	30	10		X525019	X525020

CAPPUCINO (EA)

0.7		02.1992	08.1998	NAB	1	30	10		X525023	X525024
-----	--	---------	---------	-----	---	----	----	--	---------	---------

GRAND VITARA I (FT, GT, HT)

Tout / All / Alle / Tutti / Todos		03.1998	09.2005	ADVICS	1	60	25		X114013	X114014
		03.1998	09.2005	SUMITOMO	1	57	22		X644141	X644142
		03.1998	09.2005	TOKICO	1	54	17		X674067	X674068

GRAND VITARA II (JT, TE, TD)

Tout / All / Alle / Tutti / Todos		04.2005		ADVICS	1	60	25		X114001	X114002
-----------------------------------	--	---------	--	--------	---	----	----	--	---------	---------

IGNIS I (FH)

Tout / All / Alle / Tutti / Todos		10.2000	09.2003	TOKICO	1	51	17		X674071	X674072
		10.2000	09.2003	TOKICO	1	34			X675037	X675038

IGNIS II (MH)

Tout / All / Alle / Tutti / Todos		09.2003		BOSCH	1	48	17		X274059	X274060
		09.2003		TOKICO	1	34			X675037	X675038

JIMNY (FJ)

Tout / All / Alle / Tutti / Todos		09.1998		AISIN	1	51	10		X134057	X134058
		09.1998		TOKICO	1	51			X674097	X674098

LIANA (ER, RH)

Tout / All / Alle / Tutti / Todos		07.2001		NISSIN	1	54	20		X584047	X584048
-----------------------------------	--	---------	--	--------	---	----	----	--	---------	---------

SAMURAI (SJ)

Tout / All / Alle / Tutti / Todos		11.1988	12.2004	AISIN	1	51	10		X134011	X134012
		11.1988	12.2004	GIRL-TRW	1	48	10		X374465	X374466

SPLASH (EX)

Tout / All / Alle / Tutti / Todos		01.2008		GIRL-TRW	1	54	20		X374671	X374672
-----------------------------------	--	---------	--	----------	---	----	----	--	---------	---------

SWIFT I (AA)

Tout / All / Alle / Tutti / Todos		10.1983	12.1989	AISIN	1	51	10		X134001	X134002
		10.1983	12.1986	TOKICO	1	51	17		X674001	X674002
		01.1987	12.1989	TOKICO	1	48	17		X674061	X674062

SWIFT II (AH, AJ, EA, MA)

Tout / All / Alle / Tutti / Todos		03.1989	12.2003	AISIN	1	48	17		X134003	X134004
		03.1989	12.2003	BOSCH	1	48	17		X274037	X274038
		03.1989	12.2003	TOKICO	1	48	17		X674061	X674062
		03.1989	12.2003	TOKICO	1	51	18,5		X674059	X674060
		03.1989	12.2003	TOKICO	1	30	10		X675029	X675030

Affectations par Marques

Vehicule application - Zuordnung nach Marke und Fahrzeuge - Applicazione per marca e veicolo - Aplicacion por marca y vehiculo



SUZUKI



SWIFT III (MZ, EZ)

Tout / All / Alle / Tutti / Todos		02.2005		GIRL-TRW	1	54	20		X374671	X374672
		05.2006		NISSIN	1	34	9		X585043	X585044

SWIFT IV (FZ, NZ)

Tout / All / Alle / Tutti / Todos		10.2010		NISSAN	1	51	20		X554063	X554064
		10.2010		TOKICO	1	34	9		X675051	X675052

SX4 (EY, GY)

Tout / All / Alle / Tutti / Todos		06.2006		GIRL-TRW	1	57	22		X374715	X374716
		06.2006		TOKICO	1	57	22		X674095	X674096
		06.2006		NISSIN	1	34	9		X585043	X585044

VITARA I (ET, TA)

Tout / All / Alle / Tutti / Todos		07.1988	10.2002	GIRL-TRW	1	48	10		X374471	X374472
		07.1988	10.2002	SUMITOMO	1	57	22		X644141	X644142
		07.1988	10.2002	TOKICO	1	48	10		X674069	X674070
		07.1988	10.2002	TOKICO	1	54	17		X674067	X674068

VITARA II (ET)

SE 420 HDI		12.2003	12.2005	SUMITOMO	1	57	22		X644141	X644142
------------	--	---------	---------	----------	---	----	----	--	---------	---------

WAGON R

Tout / All / Alle / Tutti / Todos		07.2003	08.2005	BOSCH	1	48	12/Ø247		X274057	X274058
		07.2003	08.2005	BOSCH	1	48	17/Ø253		X274059	X274060

WAGON R+ (EM)

Tout / All / Alle / Tutti / Todos		02.1998	05.2000	AISIN	1	51	17		X134049	X134050
-----------------------------------	--	---------	---------	-------	---	----	----	--	---------	---------

WAGON R+ (MM)

Tout / All / Alle / Tutti / Todos		05.2000		BOSCH	1	48	12/Ø247		X274057	X274058
		05.2000		BOSCH	1	48	17/Ø253		X274059	X274060

X-90 (EL)

Tout / All / Alle / Tutti / Todos		09.1995	05.1998	TOKICO	1	48	10		X674069	X674070
-----------------------------------	--	---------	---------	--------	---	----	----	--	---------	---------



TALBOT



1000 COUPE BERTONE

Tout / All / Alle / Tutti / Todos		01.1963		BENDIX	1	40			X254221	X254222
		01.1963		BENDIX	1	32			X255063	X255064

1000 VF1, VF2, VF3

Tout / All / Alle / Tutti / Todos		01.1983	12.1985	BENDIX	2	48	11		X254017	X254018
-----------------------------------	--	---------	---------	--------	---	----	----	--	---------	---------

1100 TI

1.1		09.1974	12.1981	BENDIX	2	48	11		X254017	X254018
		09.1974	08.1978	GIRL-TRW	2	48	11		X374097	X374098

1200 S

Tout / All / Alle / Tutti / Todos		06.1967	07.1971	BENDIX	1	42			X254227	X254228
		06.1967	07.1971	BENDIX	1	34			X255053	X255054

X=1 : SNRA - X=2 : EAI - X=3 : SERA - X=4 : SEEAC - X=5 : NEOTO - X=6 : STARTCAR

Affectations par Marques

Vehicule application - Zuordnung nach Marke und Fahrzeuge - Applicazione per marca e veicolo - Aplicacion por marca y vehiculo



TALBOT



160

Tout / All / Alle / Tutti / Todos		01.1970	12.1973	ATE	2	48	12,7		X224347	X224348
		09.1970		GIRL-TRW	2	48	12,7		X374327	X374328
		01.1970		BENDIX	1	38	10		X255045	X255046

180

Tout / All / Alle / Tutti / Todos		01.1970	12.1973	ATE	2	48	12,7		X224347	X224348
		09.1970		GIRL-TRW	2	48	12,7		X374327	X374328
		01.1970		BENDIX	1	38	10		X255045	X255046

1300-1301

Tout / All / Alle / Tutti / Todos		09.1965	12.1975	ATE	2	48	10,4		X224309	X224310
-----------------------------------	--	---------	---------	-----	---	----	------	--	---------	---------

1307-1308-1309

Tout / All / Alle / Tutti / Todos		01.1975	07.1979	BENDIX	1	48	11		X254065	X254066
		07.1975	07.1979	ATE	1	48	11		X224139	X224140

1500-1501

Tout / All / Alle / Tutti / Todos		09.1965	12.1975	ATE	2	48	10,4		X224309	X224310
-----------------------------------	--	---------	---------	-----	---	----	------	--	---------	---------

1510

Tout / All / Alle / Tutti / Todos		07.1979	08.1980	BENDIX	1	48	11		X254065	X254066
		08.1979	08.1980	ATE	1	48	11		X224139	X224140
		07.1980	12.1987	BENDIX	1	54	12,7		X254081	X254082
		09.1980	06.1986	ATE	1	54	12,7		X224179	X224180

AVENGER

Tout / All / Alle / Tutti / Todos		02.1970		GIRL-TRW	2	48	9,7		X374323	X374324
-----------------------------------	--	---------	--	----------	---	----	-----	--	---------	---------

HILLMANN HUNTER/MINX

Tout / All / Alle / Tutti / Todos		01.1966	12.1977	LOCK	2	54	8,8		X464079	X464080
-----------------------------------	--	---------	---------	------	---	----	-----	--	---------	---------

HORIZON

1.1		01.1979	07.1981	ATE	2	48	11		X224129	X224130
		01.1979	07.1981	BENDIX	2	48	11		X254017	X254018
		01.1979	09.1984	BENDIX	2	48	11		X254079	X254080
		01.1979	07.1981	GIRL-TRW	2	48	11		X374045	X374046

MATRA BAGHEERA (X)

Tout / All / Alle / Tutti / Todos		01.1974		ATE	2	48	11		X224417	X224418
		01.1974		BENDIX	1	45	11		X255043	X255044

MURENA

Tout / All / Alle / Tutti / Todos		09.1980		BENDIX	1	48	11		X254065	X254066
		09.1980		BENDIX	1	45	11		X255001	X255002

RANCHO

1.4		01.1977	07.1983	ATE	2	48	11		X224129	X224130
		01.1977	04.1981	BENDIX	2	48	11		X254079	X254080
		01.1977	07.1984	BENDIX	2	48	11		X254017	X254018
		01.1977	07.1983	GIRL-TRW	2	48	11		X374341	X374342

X=1 : SNRA - X=2 : EAI - X=3 : SERA - X=4 : SEEAC - X=5 : NEOTO - X=6 : STARTCAR

Affectations par Marques

Vehicule application - Zuordnung nach Marke und Fahrzeuge - Applicazione per marca e veicolo - Aplicacion por marca y vehiculo



TALBOT



SAMBA (51A)

Tout / All / Alle / Tutti / Todos		01.1981		BENDIX	1	48	10		X254083	X254084
-----------------------------------	--	---------	--	--------	---	----	----	--	---------	---------

SAMBA (51E)

Tout / All / Alle / Tutti / Todos		01.1981		BENDIX	1	48	10		X254083	X254084
-----------------------------------	--	---------	--	--------	---	----	----	--	---------	---------

SIMCA 1000

Tout / All / Alle / Tutti / Todos		09.1972		ATE	2	48	11		X224373	X224374
-----------------------------------	--	---------	--	-----	---	----	----	--	---------	---------

SIMCA 1100

Tout / All / Alle / Tutti / Todos		10.1976		ATE	2	44	11		X224313	X224314
-----------------------------------	--	---------	--	-----	---	----	----	--	---------	---------

SIMCA 1300

Tout / All / Alle / Tutti / Todos		08.1963		ATE	2	48	10,4		X224309	X224310
-----------------------------------	--	---------	--	-----	---	----	------	--	---------	---------

SIMCA 1301

Tout / All / Alle / Tutti / Todos		08.1966		ATE	2	48	10,4		X224309	X224310
-----------------------------------	--	---------	--	-----	---	----	------	--	---------	---------

SIMCA 1500

Tout / All / Alle / Tutti / Todos		10.1963		ATE	2	48	10,4		X224309	X224310
-----------------------------------	--	---------	--	-----	---	----	------	--	---------	---------

SIMCA 1501

Tout / All / Alle / Tutti / Todos		10.1966		ATE	2	48	10,4		X224309	X224310
-----------------------------------	--	---------	--	-----	---	----	------	--	---------	---------

SIMCA 1609/1610

Tout / All / Alle / Tutti / Todos		09.1976		GIRL-TRW	2	48	12,7		X374327	X374328
		09.1976		BENDIX	1	38	10		X255045	X255046

SOLARA

Tout / All / Alle / Tutti / Todos		02.1980		BENDIX	1	54	12,7		X254081	X254082
-----------------------------------	--	---------	--	--------	---	----	------	--	---------	---------

TAGORA

Tout / All / Alle / Tutti / Todos		08.1981		GIRL-TRW	2	43	10		X375017	X375018
-----------------------------------	--	---------	--	----------	---	----	----	--	---------	---------



TOYOTA



4 RUNNER I (RN10_, VZN13_, VZN10_, RN13_)

2.4 (RN61)		08.1987	03.1996	SUMITOMO	4	^{34/43}	20/Ø302		X644057	X644058
2.4 TD		08.1989	11.1995	SUMITOMO	4	43	20/Ø289		X644055	X644056
		08.1989	11.1995	SUMITOMO	4	45	25/Ø290		X644123	X644124
3.0 Turbo-D (KZN 130)		10.1993	03.1996	SUMITOMO	4	45	25/Ø290		X644123	X644124
3.0 V6 (VZN 130)		07.1990	08.1991	SUMITOMO	4	43	20/Ø289		X644055	X644056
		07.1990	11.1995	SUMITOMO	4	45	25/Ø290		X644123	X644124

4 RUNNER II (KZN18_, VZN18_, RZN18_)

Tout / All / Alle / Tutti / Todos		11.1995	08.2002	SUMITOMO	4	45	22/Ø319		X644155	X644156
		11.1995	08.2002	SUMITOMO	4	45	25/Ø290		X644123	X644124

AURIS I (_E15_)

1.8 Hybrid		10.2006	09.2012	ADVICS	1	63,4	28		X114009	X114010
		10.2006	09.2012	BOSCH	1	36	10		X275059	X275060
		10.2006	09.2012	TOKICO	1	38	9		X675045	X675046

X=1 : SNRA - X=2 : EAI - X=3 : SERA - X=4 : SEEAC - X=5 : NEOTO - X=6 : STARTCAR

Affectations par Marques

Vehicule application - Zuordnung nach Marke und Fahrzeuge - Applicazione per marca e veicolo - Aplicacion por marca y vehiculo



TOYOTA



AURIS I (_E15_)

2.2 D		10.2006	09.2012	ADVICS	1	60	22		X114011	X114012
		10.2006	09.2012	BOSCH	1	57	26/Ø295		X274103	X274104
		10.2006	09.2012	BOSCH	1	36	10		X275071	X275072
		10.2006	09.2012	TOKICO	1	38	9		X675045	X675046
Tout / All / Alle / Tutti / Todos		10.2006	09.2012	ADVICS	1	60	22		X114011	X114012
		10.2006	09.2012	BOSCH	1	57	26/Ø273		X274093	X274094
		10.2006	09.2012	BOSCH	1	57	26/Ø295		X274103	X274104
		10.2006	09.2012	BOSCH	1	36	10		X275059	X275060
		10.2006	09.2012	TOKICO	1	38	9		X675045	X675046

AURIS II (_E18_)

Tout / All / Alle / Tutti / Todos		10.2012		ADVICS	1	63,4	28		X114009	X114010
		10.2012		BOSCH	1	57	26/Ø295		X274103	X274104
		10.2012		BOSCH	1	60	26/Ø277		X274123	X274124
		10.2012		BOSCH	1	36	10		X275059	X275060
		10.2012		BOSCH	1	36	10		X275089	X275090
		10.2012		BOSCH	1	36	10		X275071	X275072

AVENSIS (ZRT27, ADT27)

1.6		02.2009		BOSCH	1	57	26/Ø295		X274103	X274104
1.8		02.2009		BOSCH	1	57	26/Ø295		X274103	X274104
2.0		02.2009		BOSCH	1	57	26/Ø295		X274103	X274104
2.0 D-4D		02.2009		BOSCH	1	57	26/Ø295		X274103	X274104
2.2 D-4D		02.2009		BOSCH	1	57	26/Ø295		X274117	X274118
Tout / All / Alle / Tutti / Todos		02.2009		BOSCH	1	38	11		X275067	X275068

AVENSIS I (T22)

Tout / All / Alle / Tutti / Todos		09.1997	02.2003	AISIN	2	40	28		X134037	X134038
		09.1997	02.2003	AISIN	2	40	28		X134047	X134048
		09.1997	02.2003	ATE	1	57	25	#ID: 821 822	X224653	X224654
		09.1997	02.2003	ATE	1	57	25	#ID: 97 98	X224471	X224472
		09.1997	02.2003	AISIN	1	38	10		X135005	X135006
		09.1997	02.2003	GIRL-TRW	1	38	10		X375365	X375366

AVENSIS II (T25)

Tout / All / Alle / Tutti / Todos		04.2003	11.2008	BOSCH	1	57	26		X274069	X274070
		04.2003	11.2008	BOSCH	1	38	10		X275035	X275036

AVENSIS III (T27)

Tout / All / Alle / Tutti / Todos		11.2008		BOSCH	1	57	26		X274103	X274104
		11.2008		BOSCH	1	38	11		X275067	X275068

AVENSIS VERSO (M2)

Tout / All / Alle / Tutti / Todos		08.2001	11.2009	AKE	1	64	28		X164279	X164280
		08.2001	11.2009	TOYOTA	1	43	12		X705005	X705006

AYGO (B1, B4)

Tout / All / Alle / Tutti / Todos		07.2005		BOSCH	1	48	20		X274087	X274088
-----------------------------------	--	---------	--	-------	---	----	----	--	---------	---------

X=1 : SNRA - X=2 : EAI - X=3 : SERA - X=4 : SEEAC - X=5 : NEOTO - X=6 : STARTCAR

Affectations par Marques

Vehicule application - Zuordnung nach Marke und Fahrzeuge - Applicazione per marca e veicolo - Aplicacion por marca y vehiculo



TOYOTA



CAMRY (_V1_) MK I

Tout / All / Alle / Tutti / Todos		01.1983	09.1986	TOYOTA	1	51	22		X704001	X704002
		10.1986	01.1988	TOYOTA	1	57	22		X704015	X704016
		08.1987	08.1988	AKE	2	43	25		X164065	X164066
		01.1988	08.1988	TOYOTA	1	57	25		X704031	X704032
		08.1987	06.1991	AISIN	1	32	10		X135001	X135002
		08.1987	06.1991	AISIN	1	35	10		X135003	X135004

CAMRY (_V1_) MK II

Tout / All / Alle / Tutti / Todos		06.1991	09.1997	AISIN	1	57	28		X134027	X134028
		06.1991	09.1997	AKE	2	43	28		X164211	X164212
		06.1991	09.1997	HOSEI	1	57	28		X384003	X384004
		03.1992	09.1997	AISIN	1	38	10		X135005	X135006
		03.1992	09.1997	AISIN	1	43	10		X135007	X135008

CAMRY (_V2_) MK I

Tout / All / Alle / Tutti / Todos		10.1986	06.1991	AKE	2	43	25		X164065	X164066
		10.1986	06.1991	TOYOTA	1	57	25		X704031	X704032
		10.1986	06.1991	AISIN	1	32	10		X135001	X135002
		10.1986	06.1991	AISIN	1	35	10		X135003	X135004

CAMRY (_V2_) MK II

Tout / All / Alle / Tutti / Todos		08.1996	11.2001	AKE	1	60	28		X164283	X164284
		08.1996	11.2001	AKE	2	43	28		X164211	X164212
		08.1996	11.2001	HOSEI	1	57	28		X384003	X384004
		08.1996	11.2001	AISIN	1	35	10		X135003	X135004
		08.1996	11.2001	AISIN	1	35	10		X135021	X135022
		08.1996	11.2001	AISIN	1	38	10		X135005	X135006

CAMRY (_V3_)

Tout / All / Alle / Tutti / Todos		08.2001	11.2006	AISIN	1	63	28		X134075	X134076
		08.2001	11.2006	AKE	1	60	28		X164283	X164284
		08.2001	11.2006	AKE	2	43	28		X164211	X164212
		08.2001	11.2006	AISIN	1	35	10		X135003	X135004
		08.2001	11.2006	AISIN	1	35	10		X135021	X135022
		08.2001	11.2006	AISIN	1	38	10		X135029	X135030

CARINA I (_T15_)

Tout / All / Alle / Tutti / Todos		10.1983	11.1987	TOYOTA	1	51	22		X704001	X704002
-----------------------------------	--	---------	---------	--------	---	----	----	--	---------	---------

CARINA I (TA10-TA12)

Tout / All / Alle / Tutti / Todos		01.1971	12.1975	AKE	1	48	10		X164169	X164170
-----------------------------------	--	---------	---------	-----	---	----	----	--	---------	---------

CARINA I (TA14)

Tout / All / Alle / Tutti / Todos		01.1975	07.1977	AKE	1	51	10		X164171	X164172
-----------------------------------	--	---------	---------	-----	---	----	----	--	---------	---------

CARINA I (TA4)

Tout / All / Alle / Tutti / Todos		01.1978	09.1983	AKE	1	51	10		X164043	X164044
		01.1978	09.1983	AKE	1	51	12,6		X164041	X164042

Affectations par Marques

Vehicule application - Zuordnung nach Marke und Fahrzeuge - Applicazione per marca e veicolo - Aplicacion por marca y vehiculo



TOYOTA



CARINA I (TA6)

Tout / All / Alle / Tutti / Todos		08.1981	09.1983	AKE	1	51	12,5		X164009	X164010
-----------------------------------	--	---------	---------	-----	---	----	------	--	---------	---------

CARINA II (_T17_)

Tout / All / Alle / Tutti / Todos		12.1987	06.1992	TOYOTA	1	54	22/Ø238		X704013	X704014
		12.1987	06.1992	TOYOTA	1	54	22/Ø248		X704015	X704016
		12.1987	06.1992	AKE	1	32	10		X165003	X165004

CARINA II (_T19_)

Tout / All / Alle / Tutti / Todos		04.1992	09.1997	AISIN	2	38	28		X134021	X134022
		04.1992	09.1997	HOSEI	1	57	25		X384001	X384002
		04.1992	09.1997	HOSEI	1	57	28		X384003	X384004
		04.1992	09.1997	AISIN	1	35	10		X135003	X135004
		04.1992	09.1997	AKE	1	35	10		X165099	X165100

CELICA I (_A2_)

Tout / All / Alle / Tutti / Todos		12.1970	07.1977	AKE	1	48	10		X164169	X164170
		12.1970	07.1977	AKE	1	51	10		X164171	X164172
		12.1970	07.1977	AKE	1	51	10		X164161	X164162
		12.1970	07.1977	AKE	1	51	12,6		X164041	X164042

CELICA II (_A4_)

Tout / All / Alle / Tutti / Todos		08.1977	07.1981	AKE	1	51	10		X164043	X164044
		08.1977	07.1981	AKE	1	51	12,6		X164041	X164042

CELICA II (_A6_)

Tout / All / Alle / Tutti / Todos		08.1981	12.1985	AKE	1	51	12,5		X164009	X164010
		08.1981	12.1985	AKE	1	57	20		X164013	X164014
		08.1981	12.1985	AKE	1	43	18		X165049	X165050

CELICA III (_T16_)

Tout / All / Alle / Tutti / Todos		09.1985	12.1989	AKE	1	54	22		X164007	X164008
		09.1985	12.1989	AKE	2	43	25		X164065	X164066
		09.1985	12.1989	TOYOTA	1	57	25		X704031	X704032
		09.1985	12.1989	AISIN	1	35	10		X135003	X135004
		09.1985	12.1989	AKE	1	32	10		X165003	X165004

CELICA IV (_T18_)

1.6 STI		10.1989	11.1993	TOYOTA	1	54	22		X704013	X704014
Tout / All / Alle / Tutti / Todos		10.1989	11.1993	TOYOTA	1	57	25		X704031	X704032
		10.1989	11.1993	AISIN	1	35	10		X135003	X135004
		10.1989	11.1993	AKE	1	32	10		X165003	X165004

CELICA V (_T20_)

1.8 i 16V		11.1993	11.1999	HOSEI	1	57	25		X384001	X384002
		11.1993	11.1999	AKE	1	32	10		X165003	X165004
2.0 Gti / 2.0 i16V		11.1993	11.1999	AISIN	1	57	28		X134027	X134028
		11.1993	11.1999	AISIN	2	40	28		X134037	X134038
		11.1993	11.1999	AKE	1	35	10		X165099	X165100
		11.1993	11.1999	AKE	1	35	10		X165099	X165100

X=1 : SNRA - X=2 : EAI - X=3 : SERA - X=4 : SEEAC - X=5 : NEOTO - X=6 : STARTCAR

Affectations par Marques

Vehicule application - Zuordnung nach Marke und Fahrzeuge - Applicazione per marca e veicolo - Aplicacion por marca y vehiculo



TOYOTA



CELICA V (_T20_)

2.0 i Turbo 4WD (ST205)		02.1994	11.1999	SUMITOMO	4	40			X644113	X644114
		02.1994	11.1999	SUMITOMO	2	38	16		X645011	X645012

CELICA VI (_T23_)

1.8 16V TS		08.1999	08.2002	AISIN	1	57	25		X134065	X134066
		08.1999	08.2002	SUMITOMO	1	34	10		X645027	X645028
1.8 16V VT-i		08.1999	07.2002	AISIN	1	57	25		X134067	X134068
		08.2002	07.2005	AISIN	1	57	25		X134065	X134066
		08.1999	07.2005	SUMITOMO	1	34	10		X645027	X645028

COROLLA I (_E7_)

Tout / All / Alle / Tutti / Todos		09.1979	12.1983	AKE	1	51	12,5		X164009	X164010
		09.1979	12.1983	SUMITOMO	1	51	13		X644033	X644034

COROLLA II (_E8_)

Tout / All / Alle / Tutti / Todos		06.1983	06.1989	AKE	1	51	18		X164185	X164186	
		06.1983	06.1989	TOYOTA	1	51	13,5		AE80 / CE80 / EE82	X704007	X704008
		06.1983	06.1989	TOYOTA	1	51	18		AE82	X704029	X704030
		06.1983	06.1989	AKE	1	32	18		AE86	X165071	X165072
		06.1983	06.1989	AKE	1	35	18		AE82	X165073	X165074

COROLLA II (KE, TE)

Tout / All / Alle / Tutti / Todos		01.1966	12.1970	AKE	1	44	10		X164155	X164156
		05.1970	05.1978	AKE	1	48	10		X164015	X164016
		05.1970	08.1979	SUMITOMO	1	48	10		X644021	X644022
		08.1974	07.1979	AKE	1	48	10		X164161	X164162
		08.1979	05.1983	SUMITOMO	1	51	12,5		X644033	X644034
		05.1982	01.1988	TOYOTA	48	51	11		X704019	X704020
		06.1983	08.1987	AKE	1	51	12,5		X164009	X164010

COROLLA II FX (E8B)

1.3		08.1984	08.1987	TOYOTA	1	51	13,5		X704007	X704008
1.6		08.1984	08.1987	AKE	1	51	18		X164185	X164186
		08.1984	08.1987	TOYOTA	1	51	18		X704021	X704022
1.6 GT 16V		08.1984	08.1987	TOYOTA	1	51	18		X704029	X704030
1.8 D		08.1984	08.1987	TOYOTA	1	51	13,5		X704007	X704008
Tout / All / Alle / Tutti / Todos		08.1984	08.1987	AKE	1	32	9		X165071	X165072
		08.1984	08.1987	AKE	1	35	10		X165073	X165074

COROLLA III (_E9_)

Tout / All / Alle / Tutti / Todos		05.1987	12.1993	TOYOTA	1	51	12		X704011	X704012
		05.1987	12.1993	TOYOTA	1	51	18		X704021	X704022
		05.1987	12.1993	AKE	1	30	9		X165015	X165016

Affectations par Marques

Vehicule application - Zuordnung nach Marke und Fahrzeuge - Applicazione per marca e veicolo - Aplicacion por marca y vehiculo



TOYOTA



COROLLA IV (_E10_)

Tout / All / Alle / Tutti / Todos		06.1991	12.1997	GIRL-TRW	1	54	22		X374577	X374578
		06.1991	12.1997	TOYOTA	1	51	18		X704021	X704022
		06.1991	12.1997	TOYOTA	1	54	22		X704025	X704026
		06.1991	12.1997	AKE	1	30	9		X165199	X165200

COROLLA V (_E11_)

Tout / All / Alle / Tutti / Todos		04.1997	06.2002	GIRL-TRW	1	54	22		X374577	X374578
		04.1997	06.2002	TOYOTA	1	51	18		X704021	X704022
		04.1997	06.2002	TOYOTA	1	51	22		X704023	X704024
		04.1997	06.2002	TOYOTA	1	54	22		X704025	X704026
		04.1997	06.2002	AKE	1	30	9		X165199	X165200
		04.1997	06.2002	AKE	1	35	9		X165155	X165156
		04.1997	06.2002	GIRL-TRW	1	38	9		X375237	X375238

COROLLA VI (_E12_)

Tout / All / Alle / Tutti / Todos		01.2001	05.2007	AISIN	1	57	25		X134065	X134066
		01.2001	05.2007	AISIN	1	57	25		X134067	X134068
		01.2001	05.2007	BOSCH	1	57	26		X274069	X274070
		01.2001	05.2007	GIRL-TRW	1	57	25		X374591	X374592
		01.2001	05.2007	TOYOTA	1	51	22		X704001	X704002
		01.2001	05.2007	BOSCH	1	38	10		X275035	X275036
		01.2001	05.2007	GIRL-TRW	1	34	9		X375393	X375394
		01.2001	05.2007	SUMITOMO	1	36	9		X645029	X645030

COROLLA VII (_E14_ , _E15_)

Tout / All / Alle / Tutti / Todos		10.2006	07.2014	ADVICS	1	60	22		X114011	X114012
		10.2006	07.2014	BOSCH	1	57	26/Ø273		X274093	X274094
		10.2006	07.2014	BOSCH	1	57	26/Ø295		X274103	X274104
		10.2006	07.2014	BOSCH	1	60	26/Ø277		X274123	X274124
		10.2006	07.2014	BOSCH	1	36	10		X275059	X275060
		10.2006	07.2014	TOKICO	1	38	9		X675045	X675046

COROLLA VIII (_E17_ , _E18_)

Tout / All / Alle / Tutti / Todos		06.2013		ADVICS	1	60	22		X114011	X114012
		06.2013		BOSCH	1	60	26		X274123	X274124
		06.2013		BOSCH	1	36	10		X275059	X275060

CORONA (RT118)

Tout / All / Alle / Tutti / Todos		11.1973	05.1979	SUMITOMO	2	54	12,5		X644015	X644016
-----------------------------------	--	---------	---------	----------	---	----	------	--	---------	---------

CORONA (T19)

Tout / All / Alle / Tutti / Todos		02.1992	09.1997	HOSEI	1	57	25		X384001	X384002
		02.1992	09.1997	HOSEI	1	57	28		X384003	X384004











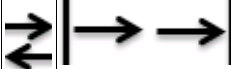



























CRESSIDA

GX71X/M72/M73/LX70/LX71		01.1985	12.1986	AKE	1	57	20		X164013	X164014
		01.1985	12.1986	AKE	1	43	18		X165049	X165050
MX/RX6_		11.1982	12.1984	SUMITOMO	1	57	22		X644137	X644138

X=1 : SNRA - X=2 : EAI - X=3 : SERA - X=4 : SEEAC - X=5 : NEOTO - X=6 : STARTCAR

Affectations par Marques

Vehicule application - Zuordnung nach Marke und Fahrzeuge - Applicazione per marca e veicolo - Aplicacion por marca y vehiculo

        											
 TOYOTA 											
CRESSIDA											
MX1_/MX2_		12.1976	08.1980	SUMITOMO	2	54	12,5			X644015	X644016
RX60X		01.1982	12.1984	SUMITOMO	1	57	18			X644073	X644074
CROWN											
Tout / All / Alle / Tutti / Todos		09.1967	09.1968	SUMITOMO	2	54	12,5			X644085	X644086
		06.1968	12.1979	SUMITOMO	2	54	12,5			X644015	X644016
		01.1979	09.1983	SUMITOMO	1	57	20			X644019	X644020
		01.1984	07.1986	SUMITOMO	2	43	18			X645013	X645014
DYNA 100 (LH8_, YH8_)											
Tout / All / Alle / Tutti / Todos		08.1985	05.1995	ASCO	1	60	25			X194005	X194006
DYNA 150											
Tout / All / Alle / Tutti / Todos		08.1987	05.1995	AISIN	1	67	30			X134015	X134016
		08.1987	05.1995	AISIN	1	67	30			X134017	X134018
DYNA 200											
Tout / All / Alle / Tutti / Todos		08.1986	05.1995	AISIN	2	51				X134019	X134020
ECHO (_P_)											
Tout / All / Alle / Tutti / Todos		04.1999	11.2005	AISIN	1	51	20			X134053	X134054
		04.1999	11.2005	BOSCH	1	51	18			X274041	X274042
		04.1999	02.2003	SUMITOMO	1	30	9			X645023	X645024
		04.1999	11.2005	SUMITOMO	1	32	9			X645025	X645026
		03.2003	11.2005	SUMITOMO	1	30	9			X645035	X645036
FJ CRUISER (GSJ1_)											
4.0 / 4.0 4WD		12.2010		SUMITOMO	1	45	18			X645049	X645050
HARRIER (_U3_)											
Tout / All / Alle / Tutti / Todos		10.2003	06.2012	AKE	1	63,5	28			X164307	X164308
		10.2003	06.2012	AKE	1	38	10			X165101	X165102
HIACE II (LH5_, YH7_, LH7_, LH6_, YH6_, YH5_)											
Tout / All / Alle / Tutti / Todos		03.1983	11.1989	AISIN	1	67	22			X134009	X134010
		03.1983	11.1989	ASCO	1	60	25			X194005	X194006
HIACE II Wagon (LH7_, LH5_, LH6_, YH7_, YH6_, YH5_)											
Tout / All / Alle / Tutti / Todos		03.1983	11.1989	AISIN	1	67	22			X134009	X134010
		03.1983	11.1989	ASCO	1	60	25			X194005	X194006
HIACE III (YH7_, LH6_, LH7_, LH5_, YH5_, YH6_)											
Tout / All / Alle / Tutti / Todos		08.1989	07.2006	AISIN	1	67	22			X134009	X134010
		08.1989	07.2006	AISIN	1	67	25			X134007	X134008
		08.1989	07.2006	AISIN	1	67	28			X134029	X134030
		08.1989	07.2006	AISIN	1	67	28			X134031	X134032

Affectations par Marques

Vehicule application - Zuordnung nach Marke und Fahrzeuge - Applicazione per marca e veicolo - Aplicacion por marca y vehiculo



TOYOTA



HIACE III Wagon (LH1_, RZH1_)

Tout / All / Alle / Tutti / Todos		08.1989	08.2004	AISIN	1	67	22		X134009	X134010
		08.1989	08.2004	AISIN	1	67	25		X134007	X134008
		08.1989	08.2004	AISIN	1	67	28		X134029	X134030
		08.1989	08.2004	AISIN	1	67	28		X134031	X134032

HIACE IV (LH1_, LXH1_, RZH1_)

Tout / All / Alle / Tutti / Todos		08.1995	08.2006	AISIN	1	67	28		X134029	X134030
		08.1995	08.2006	AISIN	1	67	28		X134031	X134032

HIACE V (TRH2_, KDH2_)

Tout / All / Alle / Tutti / Todos		01.2005		AISIN	1	67	28		X134029	X134030
-----------------------------------	--	---------	--	-------	---	----	----	--	---------	---------

HILUX I (_N2_, _N3_, _N4_)

Tout / All / Alle / Tutti / Todos		05.1972	03.1984	SUMITOMO	2	54	12,5		X644015	X644016
-----------------------------------	--	---------	---------	----------	---	----	------	--	---------	---------

HILUX II (_N5_, _N6_)

Tout / All / Alle / Tutti / Todos		01.1981	12.1989	ASCO	1	60	25		X194005	X194006
		01.1981	12.1989	SUMITOMO	4	^{34/43}	12,5		X644053	X644054
		01.1981	12.1989	SUMITOMO	4	43	20		X644055	X644056

HILUX III (KUN_, TGN_, LAN_, GGN_)

Tout / All / Alle / Tutti / Todos		11.2004		GIRL-TRW	1	60	26		X374725	X374726
		11.2004		GIRL-TRW	4	43	26		X374701	X374702
		11.2004		SUMITOMO	1	60	26		X644213	X644214
		11.2004		SUMITOMO	4	43	26		X644197	X644198

HILUX IV (_N1_, _N2_, _N3_)

Tout / All / Alle / Tutti / Todos		05.2015		GIRL-TRW	4	43	25/Ø297		X374767	X374768
-----------------------------------	--	---------	--	----------	---	----	---------	--	---------	---------

IQ (KPJ1_, NGJ1_, KGJ1_, NUJ1_)

Tout / All / Alle / Tutti / Todos		01.2009		SUMITOMO	1	48	20		X644199	X644200
		01.2009		TOKICO	1	34	9		X675039	X675040

LAND CRUISER (_J1_) 100

Tout / All / Alle / Tutti / Todos		01.1998	07.2003	SUMITOMO	4	^{45/51}	32		X644153	X644154
		01.1998	07.2003	SUMITOMO	1	48	18		X645015	X645016

LAND CRUISER (_J1_) 120

Tout / All / Alle / Tutti / Todos		01.1998	08.2007	SUMITOMO	4	45	18		X644163	X644164
		01.1998	08.2007	SUMITOMO	1	45	18		X645049	X645050
		01.1998	08.2007	SUMITOMO	1	48	18		X645031	X645032

LAND CRUISER (_J1_) 150

Tout / All / Alle / Tutti / Todos		01.2010		SUMITOMO	4	48	32		X644219	X644220
		01.2010		SUMITOMO	1	48	18		X645031	X645032

LAND CRUISER (_J2_) 200

Tout / All / Alle / Tutti / Todos		08.2007		SUMITOMO	4	51	32		X644205	X644206
		08.2007		SUMITOMO	1	45	18		X645047	X645048

LAND CRUISER (_J6_)

Tout / All / Alle / Tutti / Todos		10.1981	12.1989	SUMITOMO	4	^{34/43}	20/Ø302		X644057	X644058
-----------------------------------	--	---------	---------	----------	---	------------------	---------	--	---------	---------

X=1 : SNRA - X=2 : EAI - X=3 : SERA - X=4 : SEEC - X=5 : NEOTO - X=6 : STARTCAR

Affectations par Marques

Vehicule application - Zuordnung nach Marke und Fahrzeuge - Applicazione per marca e veicolo - Aplicacion por marca y vehiculo



TOYOTA



LAND CRUISER (_J7_)

Tout / All / Alle / Tutti / Todos		11.1984	08.2001	SUMITOMO	4	34/43	12,5/Ø302		X644053	X644054
		11.1984	08.2001	SUMITOMO	4	34/43	20/Ø302		X644057	X644058
		11.1984	08.2001	SUMITOMO	4	43	20/Ø289		X644055	X644056
		11.1984	08.2001	SUMITOMO	4	45	20/Ø285		X644125	X644126
		11.1984	08.2001	SUMITOMO	1	48	18		X645009	X645010

LAND CRUISER 80 (_J8_)

Tout / All / Alle / Tutti / Todos		01.1990	02.1998	SUMITOMO	4	45	20/Ø285		X644125	X644126
		01.1990	02.1998	SUMITOMO	4	45	30/Ø311		X644127	X644128
		01.1990	02.1998	SUMITOMO	1	48	18		X645009	X645010

LAND CRUISER 90 (_J9_)

Tout / All / Alle / Tutti / Todos		04.1995	12.2002	SUMITOMO	4	45	22		X644155	X644156
		04.1995	12.2002	SUMITOMO	1	48	18		X645009	X645010

LITEACE (_R2_ _V, _R2_ _LG)

Tout / All / Alle / Tutti / Todos		01.1992	08.1997	AKE	1	60			X164231	X164232
		01.1992	08.1997	AKE	2	43	25		X164247	X164248

LITEACE (CM3_ _V, KM3_ _V)

1.5 (KM31_ _V, KM36_ _V)		05.1986	09.1991	AKE	1	57	20		X164067	X164068
		05.1986	09.1991	AKE	2	43	20		X164071	X164072
1.8 (YM21)		01.1984	12.1985	ASCO	1	60	25		X194005	X194006
1.8 D (CM35_ _V)		10.1985	08.1988	AKE	1	57	20		X164067	X164068
		10.1985	08.1988	AKE	2	43	20		X164071	X164072
2.0 D (CM36_ _V)		08.1988	01.1992	AKE	1	57	20		X164067	X164068
		08.1988	01.1992	AKE	2	43	20		X164071	X164072

LITEACE (CM30_ _G, KM30_ _G)

1.5 (KM30LG)		10.1985	01.1992	AKE	1	57	20		X164067	X164068
		10.1985	01.1992	AKE	2	43	20		X164071	X164072
2.0 D (CM30LG)		08.1988	01.1992	AKE	2	43	20		X164071	X164072

MATRIX (ZZE13_)

Tout / All / Alle / Tutti / Todos		09.2001		AISIN	1	57	25		X134065	X134066
		09.2001		SUMITOMO	1	36	9		X645029	X645030

MODELL F (_R2_ , 31)

Tout / All / Alle / Tutti / Todos		11.1982		AKE	2	43	20		X164071	X164072
-----------------------------------	--	---------	--	-----	---	----	----	--	---------	---------

MR 2 I (AW1_)

Tout / All / Alle / Tutti / Todos		06.1984		TOYOTA	1	51	18		X704029	X704030
		06.1984		AKE	1	36	10		X165061	X165062

MR 2 II (SW2_)

2.0		12.1989	12.1991	AISIN	2	36	25		X134023	X134024
		12.1989	08.1992	AISIN	2	36	30		X134025	X134026
		12.1989	12.1991	AKE	1	41	16		X165095	X165096
		12.1989	08.1992	AKE	1	43	22		X165097	X165098

X=1 : SNRA - X=2 : EAI - X=3 : SERA - X=4 : SEEAC - X=5 : NEOTO - X=6 : STARTCAR

Affectations par Marques

Vehicule application - Zuordnung nach Marke und Fahrzeuge - Applicazione per marca e veicolo - Aplicacion por marca y vehiculo



TOYOTA



MR 2 II (SW2_)

2.0 16V		12.1989	05.2000	AISIN	2	36	25		X134023	X134024
		12.1989	05.2000	AISIN	2	36	30		X134025	X134026
		12.1989	05.2000	AKE	1	41	16		X165095	X165096
		12.1989	05.2000	AKE	1	43	22		X165097	X165098
2.0 16V (SW20)		12.1989	12.1991	AISIN	2	36	25		X134023	X134024
		12.1989	05.2000	AISIN	2	36	30		X134025	X134026
		12.1989	12.1991	AKE	1	41	16		X165095	X165096
		12.1989	05.2000	AKE	1	43	22		X165097	X165098

MR III (ZZW3_)

1.8 16V VT-i (ZZW30)		10.1999	06.2007	AKE	1	45	16,5		X165173	X165174
		10.1999	07.2002	AKE	1	45	16,5		X165171	X165172
Tout / All / Alle / Tutti / Todos		10.1999		AISIN	1	51	20		X134063	X134064

PASEO (EL54)

Tout / All / Alle / Tutti / Todos		08.1995		TOYOTA	1	48	18		X704037	X704038
-----------------------------------	--	---------	--	--------	---	----	----	--	---------	---------

PICNIC (_XM10)

Tout / All / Alle / Tutti / Todos		05.1996		AISIN	1	57	28		X134059	X134060
-----------------------------------	--	---------	--	-------	---	----	----	--	---------	---------

PREVIA (MCR3_, ACR3_, CLR3_)

Tout / All / Alle / Tutti / Todos		08.2000		AKE	1	63,5	28		X164275	X164276
		08.2000		TOYOTA	1	43	12		X705005	X705006

PREVIA (TCR2_, TCR1_)

2.4		05.1990	08.2000	AKE	1	60	22		X164273	X164274
		05.1990	08.1996	AKE	2	45	25		X164221	X164222
2.4 4WD		05.1990	08.2000	AKE	1	60	22		X164273	X164274
		05.1990	08.1996	AKE	2	45	25		X164221	X164222
Tout / All / Alle / Tutti / Todos		05.1990		TOYOTA	1	43	18		X705001	X705002

PREVIA III (ACR5_, GSR5_)

Tout / All / Alle / Tutti / Todos		10.2005		TOYOTA	1	63,5	28		X704043	X704044
-----------------------------------	--	---------	--	--------	---	------	----	--	---------	---------

PRIUS (NHW11_)

Tout / All / Alle / Tutti / Todos		05.2000		AISIN	1	57	25		X134067	X134068
		05.2000		SUMITOMO	1	34	10		X645027	X645028

PRIUS (NHW20_)

1.5		08.2003	03.2009	AISIN	1	35	9		X135023	X135024
		08.2003	08.2004	SUMITOMO	1	36	9		X645029	X645030
Tout / All / Alle / Tutti / Todos		08.2003		ADVICS	1	54	22		X114005	X114006

PRIUS (ZVW3_)

Tout / All / Alle / Tutti / Todos		04.2009		SUMITOMO	1	57	25		X644187	X644188
		04.2009		TOKICO	1	38	9		X675045	X675046

RAV 4 I (_A1_)

Tout / All / Alle / Tutti / Todos		06.1994	09.2000	SUMITOMO	1	54	18		X644115	X644116
-----------------------------------	--	---------	---------	----------	---	----	----	--	---------	---------

X=1 : SNRA - X=2 : EAI - X=3 : SERA - X=4 : SEEAC - X=5 : NEOTO - X=6 : STARTCAR

Affectations par Marques

Vehicule application - Zuordnung nach Marke und Fahrzeuge - Applicazione per marca e veicolo - Aplicacion por marca y vehiculo



TOYOTA



RAV 4 II (_A2_)

Tout / All / Alle / Tutti / Todos		06.2000	11.2005	SUMITOMO	1	60	25		X644143	X644144
		06.2000	11.2005	SUMITOMO	1	32	9,5		X645017	X645018

RAV 4 III (_A3_)

Tout / All / Alle / Tutti / Todos		11.2005	12.2013	ADVICS	1	63,4	28		X114009	X114010
		11.2005	12.2013	ADVICS	1	38	12		X115001	X115002

RAV 4 IV (_A4_)

Tout / All / Alle / Tutti / Todos		12.2012		ADVICS	1	63,4	28		X114009	X114010
		12.2012		AKE	2	45	28		X164327	X164328
		12.2012		ADVICS	1	38	12		X115001	X115002

SCEPTER

2.2		11.1992	09.1996	AKE	2	43	28		X164211	X164212
		11.1992	09.1996	HOSEI	1	57	28		X384003	X384004
		11.1992	09.1996	AISIN	1	35	10		X135003	X135004

STARLET (_P6_)

Tout / All / Alle / Tutti / Todos		02.1978	12.1984	TOYOTA	1	48	10		X704041	X704042
-----------------------------------	--	---------	---------	--------	---	----	----	--	---------	---------

STARLET (_P7_)

Tout / All / Alle / Tutti / Todos		10.1984	12.1989	TOYOTA	1	48	12,5		X704005	X704006
		10.1984	12.1989	TOYOTA	1	48	16		X704009	X704010

STARLET (_P8_)

Tout / All / Alle / Tutti / Todos		12.1989	03.1996	TOYOTA	1	48	16	ABS	X704033	X704034
		12.1989	03.1996	TOYOTA	1	51	18	ABS	X704035	X704036

STARLET (_P9_)

Tout / All / Alle / Tutti / Todos		04.1996	03.1999	TOYOTA	1	48	16		X704033	X704034
		04.1996	03.1999	TOYOTA	1	48	18		X704037	X704038
		04.1996	03.1999	TOYOTA	1	51	18		X704035	X704036

SUPRA (A70_)

Tout / All / Alle / Tutti / Todos		01.1986	05.1993	AKE	1	60	22		X164069	X164070
		01.1986	05.1993	AKE	1	38	18		X165019	X165020

SUPRA (A80_)

3.0 i Bi-Turbo		05.1993	08.2002	AKE	2	45	32		X164245	X164246
		05.1993	08.2002	SUMITOMO	4	43	30		X644121	X644122
Tout / All / Alle / Tutti / Todos		05.1993	08.2002	SUMITOMO	1	40	16		X645007	X645008

TERCEL (_L1_, _L2_)

Tout / All / Alle / Tutti / Todos		03.1979	01.1988	TOYOTA	1	48	11		X704019	X704020
-----------------------------------	--	---------	---------	--------	---	----	----	--	---------	---------

TERCEL (_L5_)

1.3		05.1992	11.1997	TOYOTA	1	48	18	ABS	X704037	X704038
		11.1994	09.1999	TOYOTA	1	51	18	ABS	X704035	X704036
1.5		05.1982	10.1985	TOYOTA	1	48	11		X704019	X704020
		11.1987	10.1989	TOYOTA	1	48	12,5		X704005	X704006
		11.1987	10.1989	TOYOTA	1	48	16		X704009	X704010

X=1 : SNRA - X=2 : EAI - X=3 : SERA - X=4 : SEEAC - X=5 : NEOTO - X=6 : STARTCAR

Affectations par Marques

Vehicule application - Zuordnung nach Marke und Fahrzeuge - Applicazione per marca e veicolo - Aplicacion por marca y vehiculo



TOYOTA



TERCEL (_L5_)

1.5 4WD		08.1982	10.1985	TOYOTA	1	48	11		X704019	X704020
---------	--	---------	---------	--------	---	----	----	--	---------	---------

URBAN CRUISER (NSP1_, NLP1_, ZSP1_, NCP11_)

Tout / All / Alle / Tutti / Todos		04.2009		ADVICS	1	60	22		X114011	X114012
		04.2009		TOKICO	1	34	9		X675039	X675040

VERSO (_R2_)

1.6		04.2009		BOSCH	1	57	26/Ø295		X274103	X274104
1.6 D4-D		11.2013		BOSCH	1	57	26/Ø295		X274103	X274104
1.8		04.2009		BOSCH	1	57	26/Ø295		X274103	X274104
2.0 D-4D		04.2009		BOSCH	1	57	26/Ø295		X274103	X274104
2.2 D-4D		04.2009		BOSCH	1	57	26/Ø295		X274117	X274118
2.2 D-CAT		04.2009		BOSCH	1	57	26/Ø295		X274117	X274118
Tout / All / Alle / Tutti / Todos		04.2009		BOSCH	1	38	10		X275077	X275078

VERSO S (_P12_)

1.33		11.2010	10.2016	ADVICS	1	60	22		X114011	X114012
1.4 D4-D		11.2010	10.2016	ADVICS	1	60	22		X114011	X114012
1.5		11.2010	10.2016	AISIN	1	57	22		X134071	X134072
Tout / All / Alle / Tutti / Todos		11.2010	10.2016	TOKICO	1	34	9		X675039	X675040

YARIS I (_P1_)

Tout / All / Alle / Tutti / Todos		04.1999	09.2005	AISIN	1	51	18/Ø235		X134051	X134052
		04.1999	09.2005	AISIN	1	51	20/Ø255		X134053	X134054
		04.1999	09.2005	BOSCH	1	51	18		X274041	X274042
		04.1999	09.2005	SUMITOMO	1	30	10		X645023	X645024
		04.1999	09.2005	SUMITOMO	1	30	9		X645035	X645036

YARIS II (_P9_)

Tout / All / Alle / Tutti / Todos		08.2005	12.2012	AISIN	1	54	22		X134069	X134070
		08.2005	12.2012	AISIN	1	57	22		X134071	X134072
		08.2005	12.2012	ATE	1	54	22		X224727	X224728
		08.2005	12.2012	ATE	1	34	9		X225329	X225330
		08.2005	12.2012	TOKICO	1	34	9		X675039	X675040

YARIS III (_P13_)

Tout / All / Alle / Tutti / Todos		12.2010		AISIN	1	54	22		X134069	X134070
		12.2010		AISIN	1	57	22		X134071	X134072
		12.2010		ATE	1	54	22		X224727	X224728
		12.2010		ATE	1	34	9		X225329	X225330

YARIS VERSO (_P2_)

Tout / All / Alle / Tutti / Todos		08.1999	09.2005	AISIN	1	51	20		X134053	X134054
		08.1999	09.2005	SUMITOMO	1	32	8		X645025	X645026



TRIUMPH



GT6

Tout / All / Alle / Tutti / Todos		12.1972	12.1973	GIRL-TRW	2	54	12,7		X374351	X374352
-----------------------------------	--	---------	---------	----------	---	----	------	--	---------	---------

X=1 : SNRA - X=2 : EAI - X=3 : SERA - X=4 : SEEC - X=5 : NEOTO - X=6 : STARTCAR

Affectations par Marques

Vehicule application - Zuordnung nach Marke und Fahrzeuge - Applicazione per marca e veicolo - Aplicacion por marca y vehiculo



TRIUMPH

HERALD

Tout / All / Alle / Tutti / Todos		01.1967	12.1971	GIRL-TRW	2	48	9,5		X374283	X374284
-----------------------------------	--	---------	---------	----------	---	----	-----	--	---------	---------

TR 6

Tout / All / Alle / Tutti / Todos		01.1969	12.1976	GIRL-TRW	2	54	12,7		X374351	X374352
-----------------------------------	--	---------	---------	----------	---	----	------	--	---------	---------

TR 7

Tout / All / Alle / Tutti / Todos		01.1976	12.1982	LOCK	2	51	9,5		X464069	X464070
-----------------------------------	--	---------	---------	------	---	----	-----	--	---------	---------

VAUXHALL

VIVA HA-90

Tout / All / Alle / Tutti / Todos		09.1963	08.1966	GIRL-TRW	2	43	9,5		X374587	X374588
-----------------------------------	--	---------	---------	----------	---	----	-----	--	---------	---------

VIVA HB

Tout / All / Alle / Tutti / Todos		01.1967	01.1970	LOCK	2	50,8	9,5		X464111	X464112
-----------------------------------	--	---------	---------	------	---	------	-----	--	---------	---------



VOLKSWAGEN



411

Tout / All / Alle / Tutti / Todos		07.1968	12.1970	ATE	2	42	11		->4102034116	X224063	X224064
		01.1971	08.1973	ATE	2	42	11		4102034117->	X224387	X224388

412

Tout / All / Alle / Tutti / Todos		01.1972	12.1974	ATE	2	42	11		X224389	X224390
-----------------------------------	--	---------	---------	-----	---	----	----	--	---------	---------

1200

Tout / All / Alle / Tutti / Todos		10.1960	12.1985	ATE	2	40	9,5		X224013	X224014
-----------------------------------	--	---------	---------	-----	---	----	-----	--	---------	---------

1300

Tout / All / Alle / Tutti / Todos		08.1967	08.1971	ATE	2	40	9,5		X224013	X224014
		08.1971	12.1974	ATE	2	40	9,5		X224069	X224070
		08.1971	12.1974	ATE	2	40	9,5		X224669	X224670
		01.1976	05.1981	VARGA	2	40			X714001	X714002

1300 S

Tout / All / Alle / Tutti / Todos		09.1972	12.1973	GIRL-TRW	2	40	9,5		X374053	X374054
-----------------------------------	--	---------	---------	----------	---	----	-----	--	---------	---------

1302

Tout / All / Alle / Tutti / Todos		08.1970	08.1971	ATE	2	40	9,5		X224013	X224014
		08.1970	07.1972	GIRL-TRW	2	40	9,5		X374053	X374054
		08.1971	07.1972	ATE	2	40	9,5		X224069	X224070
		08.1971	07.1972	ATE	2	40	9,5		X224669	X224670

1303

Tout / All / Alle / Tutti / Todos		08.1972	12.1980	ATE	2	40	9,5		X224069	X224070
		08.1972	12.1980	ATE	2	40	9,5		X224669	X224670
		08.1972	12.1980	GIRL-TRW	2	40	9,5		X374053	X374054

Affectations par Marques

Vehicule application - Zuordnung nach Marke und Fahrzeuge - Applicazione per marca e veicolo - Aplicacion por marca y vehiculo



VOLKSWAGEN



1500,1600

Tout / All / Alle / Tutti / Todos		04.1961	07.1973	ATE	2	40	9,5		KARMAN GHIA	X224013	X224014
		04.1961	07.1973	ATE	2	42	11			X224063	X224064
		04.1961	07.1973	ATE	2	42	9,5			X224011	X224012
		04.1961	07.1973	ATE	2	42	9,7			X225007	X225008

AMAROK

Tout / All / Alle / Tutti / Todos		09.2010		BOSCH	2	48	28			X274111	X274112
-----------------------------------	--	---------	--	-------	---	----	----	--	--	---------	---------

BEETLE (5C)

Tout / All / Alle / Tutti / Todos		07.2011		ATE	1	54	22/Ø256 ~280			X224455	X224456
		07.2011		ATE	1	54	25/Ø288 ~312			X224619	X224620
		07.2011		BOSCH	1	38	10/Ø272			X275065	X275066
		07.2011		GIRL-TRW	1	38	10/Ø253			X375293	X375294

BORA (1J)

Tout / All / Alle / Tutti / Todos		10.1998	05.2005	ATE	1	54	22/Ø256 ~280			X224455	X224456
		10.1998	05.2005	ATE	1	54	25/Ø288 ~312			X224249	X224250
		10.1998	05.2005	GIRL-TRW	1	38	22			X375255	X375256
		10.1998	05.2005	GIRL-TRW	1	41	9			X375191	X375192
		10.1998	05.2005	GIRL-TRW	1	41	9			X375193	X375194

BORA (1K)

Tout / All / Alle / Tutti / Todos		08.2005	10.2010	ATE	1	54	22/Ø256 ~280			X224455	X224456
		08.2005	10.2010	ATE	1	54	25/Ø288 ~312			X224619	X224620
		08.2005	10.2010	BOSCH	1	38	10			X275065	X275066
		08.2005	10.2010	GIRL-TRW	1	38	12			X375377	X375378
		08.2005	10.2010	GIRL-TRW	1	41	9			X375313	X375314

CADDY I (14)

Tout / All / Alle / Tutti / Todos		08.1982	07.1992	VW	1	48	12			X734001	X734002
-----------------------------------	--	---------	---------	----	---	----	----	--	--	---------	---------

CADDY II (9K9A, 9K9B)

Tout / All / Alle / Tutti / Todos		11.1995	01.2004	GIRL-TRW	1	54	20			X374037	X374038
-----------------------------------	--	---------	---------	----------	---	----	----	--	--	---------	---------

CADDY II PICK UP (9U7)

Tout / All / Alle / Tutti / Todos		06.1996	12.2000	GIRL-TRW	1	54	12,9			X374203	X374204
-----------------------------------	--	---------	---------	----------	---	----	------	--	--	---------	---------

CADDY III (2K, 2C)

1.2 TSI		03.2004	05.2015	ATE	1	54	22/Ø256 ~280			X224455	X224456
		03.2004	05.2015	ATE	1	54	25/Ø288 ~312			X224619	X224620
Tout / All / Alle / Tutti / Todos		03.2004	05.2006	GIRL-TRW	1	41	10			X375329	X375330
		09.2010	05.2015	BOSCH	1	38	10			X275065	X275066
		09.2010	05.2015	BOSCH	1	38	10			X275073	X275074
		09.2010	05.2015	GIRL-TRW	1	38	10			X375397	X375398

CC (358)

1.4 TSI		11.2011	12.2016	ATE	1	54	25			X224619	X224620
		11.2011	12.2016	GIRL-TRW	1	38	12			X377001	X377002
2.0 TDI		11.2011	12.2016	ATE	1	54	25			X224619	X224620
		11.2011	12.2016	GIRL-TRW	1	38	12			X377001	X377002

X=1 : SNRA - X=2 : EAI - X=3 : SERA - X=4 : SEEAC - X=5 : NEOTO - X=6 : STARTCAR

Affectations par Marques

Vehicule application - Zuordnung nach Marke und Fahrzeuge - Applicazione per marca e veicolo - Aplicacion por marca y vehiculo



VOLKSWAGEN



CC (358)

Tout / All / Alle / Tutti / Todos		11.2011		ATE	1	54	25/Ø288-312		X224619	X224620
-----------------------------------	--	---------	--	-----	---	----	-------------	--	---------	---------

CORRADO (53I)

Tout / All / Alle / Tutti / Todos		09.1988	12.1995	GIRL-TRW	1	54	20		X374037	X374038
		09.1988	12.1995	GIRL-TRW	1	54	22		X374133	X374134
		09.1988	12.1995	GIRL-TRW	1	38	10	#ID: 2728 2729	X375031	X375032
		09.1988	12.1995	GIRL-TRW	1	38	10	#ID: 443_ / 725_	X375123	X375124
		09.1988	12.1995	GIRL-TRW	1	38	10	#ID: 443_ / 725_	X375141	X375142

CRAFTER

Tout / All / Alle / Tutti / Todos		04.2006	12.2016	BREMBO	2	48	28		X284099	X284100
		04.2006	12.2016	BREMBO	2	52	28		X284087	X284088
		04.2006	12.2016	BOSCH	1	51	16		X275045	X275046
		04.2006	12.2016	BOSCH	2	48	28		X275039	X275040

DERBY I (86)

Tout / All / Alle / Tutti / Todos		07.1976	09.1981	ATE	1	44	8		X224091	X224092
-----------------------------------	--	---------	---------	-----	---	----	---	--	---------	---------

DERBY II (86C, 80)

Tout / All / Alle / Tutti / Todos		10.1981	02.1985	ATE	1	44	10		X224115	X224116
		03.1985	12.1988	VW	1	48	10		X734003	X734004

EOS (1F7, 1F8)

2.0 TSI		11.2009	08.2015	ATE	1	54	25/Ø288-312		X224619	X224620
		11.2009	08.2015	ATE	1	57	25-30/Ø345		X224725	X224726
		11.2009	08.2015	GIRL-TRW	1	38	10/Ø253		X375293	X375294
		11.2009	11.2010	GIRL-TRW	1	38	12/Ø282		X375377	X375378
		12.2010	08.2015	BOSCH	1	38	10/Ø272		X275065	X275066
3.2 V6		06.2006	05.2009	ATE	1	54	25/Ø288-312		X224619	X224620
		06.2006	05.2009	ATE	1	57	25-30/Ø345		X224725	X224726
		06.2006	05.2009	GIRL-TRW	1	38	10/Ø255		X375293	X375294
		06.2006	05.2009	GIRL-TRW	1	38	12/Ø282		X375377	X375378
		06.2006	05.2009	GIRL-TRW	1	41	22		X375379	X375380
3.6 V6		05.2009	11.2010	ATE	1	54	25/Ø288-312		X224619	X224620
		05.2009	11.2010	ATE	1	57	25-30/Ø345		X224725	X224726
		05.2009	11.2010	GIRL-TRW	1	38	10/Ø255		X375293	X375294
		05.2009	11.2010	GIRL-TRW	1	38	12/Ø282		X375377	X375378
		05.2009	11.2010	GIRL-TRW	1	41	22		X375379	X375380
Tout / All / Alle / Tutti / Todos		03.2006	08.2015	ATE	1	54	25		X224619	X224620
		03.2006	08.2015	GIRL-TRW	1	38	10		X375293	X375294

FLIGHT (6KV2)

Tout / All / Alle / Tutti / Todos		11.1995	01.2002	ATE	1	48	20		X224453	X224454
		11.1995	01.2002	GIRL-TRW	1	54	20		X374037	X374038
		11.1995	01.2002	VW	1	48	10		X734003	X734004
		11.1995	01.2002	VW	1	48	12		X734007	X734008
		11.1995	01.2002	GIRL-TRW	1	34	9		X375253	X375254

X=1 : SNRA - X=2 : EAI - X=3 : SERA - X=4 : SEEAC - X=5 : NEOTO - X=6 : STARTCAR

Affectations par Marques

Vehicule application - Zuordnung nach Marke und Fahrzeuge - Applicazione per marca e veicolo - Aplicacion por marca y vehiculo



VOLKSWAGEN



FOX (5Z1, 5Z3)

Tout / All / Alle / Tutti / Todos		04.2005	12.2011	ATE	1	54	22		X224455	X224456
		04.2005	12.2011	BENDIX	1	48	18		X254213	X254214

GOLF I (15) Cabriolet

1.1		01.1979	07.1983	GIRL-TRW	2	44	10		X374073	X374074
1.6 GLI		08.1979	07.1980	ATE	1	44	20		X224131	X224132
Tout / All / Alle / Tutti / Todos		09.1978	08.1993	VW	1	48	12		X734001	X734002
		08.1979	07.1983	ATE	1	44	10		X224115	X224116

GOLF I (17)

Tout / All / Alle / Tutti / Todos		04.1974	07.1985	ATE	1	44	10		X224115	X224116
		04.1974	07.1985	ATE	1	44	12		X224375	X224376
		04.1974	07.1985	ATE	1	44	20		X224131	X224132
		04.1974	07.1985	BREMBO	2	60	30		X284039	X284040
		04.1974	07.1985	GIRL-TRW	2	44	10		X374073	X374074
		04.1974	07.1985	GIRL-TRW	2	44	12		X374063	X374064
		04.1974	07.1985	VW	1	48	12		X734001	X734002

GOLF II (19E, 1G1)

Tout / All / Alle / Tutti / Todos		03.1983	12.1992	GIRL-TRW	1	54	20	#ID: 356_ / 150_	X374037	X374038
		03.1983	12.1992	GIRL-TRW	1	54	22	#ID: 209_ / 357_	X374133	X374134
		03.1983	12.1992	GIRL-TRW	2	44	10		X374073	X374074
		03.1983	12.1992	VW	1	48	10		X734003	X734004
		03.1983	12.1992	VW	1	48	12		X734001	X734002
		03.1983	12.1992	VW	1	48	12		X734007	X734008
		03.1983	12.1992	GIRL-TRW	1	36	10	#ID: 183_ / 245_	X375025	X375026
		03.1983	12.1992	GIRL-TRW	1	38	10	#ID: 2728 2729	X375031	X375032

GOLF III (1H, 1E)

Tout / All / Alle / Tutti / Todos		08.1991	04.1999	ATE	1	48	20		X224453	X224454
		08.1991	04.1999	ATE	1	54	25/Ø288 -312		X224249	X224250
		08.1991	04.1999	GIRL-TRW	1	54	13		X374205	X374206
		08.1991	04.1999	GIRL-TRW	1	54	20		X374037	X374038
		08.1991	04.1999	GIRL-TRW	1	54	22		X374151	X374152
		08.1991	04.1999	VW	1	48	12		X734001	X734002
		08.1991	04.1999	VW	1	48	12		X734007	X734008
		08.1991	04.1999	GIRL-TRW	1	38	10	#ID: 2728 2729	X375031	X375032
		08.1991	04.1999	GIRL-TRW	1	38	10	#ID: 443_ / 725_	X375123	X375124
		08.1991	04.1999	GIRL-TRW	1	38	10	#ID: 443_ / 725_	X375141	X375142

GOLF IV (1E7) Caabriolet

1.6		06.1998	06.2002	GIRL-TRW	1	54	13		X374205	X374206
		06.1998	06.2002	GIRL-TRW	1	54	20		X374037	X374038
		06.1998	06.2002	GIRL-TRW	1	38	10/Ø226 -232	#ID: 443_ / 725_	X375123	X375124
		06.1998	06.2002	GIRL-TRW	1	38	10/Ø226 -232	#ID: 443_ / 725_	X375141	X375142
		06.1998	06.2002	GIRL-TRW	1	38	9/Ø232	#ID: 60_	X375143	X375144

X=1 : SNRA - X=2 : EAI - X=3 : SERA - X=4 : SEEAC - X=5 : NEOTO - X=6 : STARTCAR

Affectations par Marques

Vehicule application - Zuordnung nach Marke und Fahrzeuge - Applicazione per marca e veicolo - Aplicacion por marca y vehiculo



VOLKSWAGEN



GOLF IV (1J)

Tout / All / Alle / Tutti / Todos		08.1997	06.2005	ATE	1	54	22/Ø256-280		X224455	X224456
		08.1997	06.2005	ATE	1	54	25/Ø288-312		X224249	X224250
		08.1997	06.2005	GIRL-TRW	1	38	22		X375255	X375256
		08.1997	06.2005	GIRL-TRW	1	38	9/Ø232		X375143	X375144
		08.1997	06.2005	GIRL-TRW	1	38	9/Ø232		X375275	X375276
		08.1997	06.2005	GIRL-TRW	1	41	9/Ø245		X375193	X375194

GOLF PLUS (5M1, 521)

Tout / All / Alle / Tutti / Todos		01.2005	12.2013	ATE	1	54	22/Ø256-280		X224455	X224456
		01.2005	12.2013	ATE	1	54	25/Ø288-312		X224619	X224620
		01.2005	12.2013	GIRL-TRW	1	38	10/Ø253		X375293	X375294
		01.2005	12.2013	GIRL-TRW	1	38	12/Ø282		X375377	X375378

GOLF V (1K)

1.8 GTI		08.2006	11.2008	ATE	1	57	30		X224249	X224250
		08.2006	11.2008	GIRL-TRW	1	38	22		X375255	X375256
3.2 R32		01.2004	11.2008	ATE	1	57	25-30/Ø345		X224725	X224726
		01.2004	11.2008	GIRL-TRW	1	41	22		X375379	X375380
Tout / All / Alle / Tutti / Todos		10.2003	02.2009	ATE	1	54	22/Ø256-280		X224455	X224456
		10.2003	02.2009	ATE	1	54	25/Ø288-312		X224619	X224620
		10.2003	02.2009	GIRL-TRW	1	38	10/Ø253		X375293	X375294
		10.2003	02.2009	GIRL-TRW	1	38	12/Ø282		X375377	X375378
		10.2003	02.2009	GIRL-TRW	1	41	12/Ø282		X375313	X375314

GOLF VI (517) Décapotable

Tout / All / Alle / Tutti / Todos		03.2011		ATE	1	54	25/Ø288-312		X224619	X224620
		03.2011		ATE	1	57	30/Ø340		X224741	X224742
		03.2011		BOSCH	1	38	10		X275065	X275066
		03.2011		GIRL-TRW	1	38	10		X375293	X375294
		03.2011		GIRL-TRW	1	41	22		X375379	X375380

GOLF VI (5K1)

Tout / All / Alle / Tutti / Todos		10.2008	11.2013	ATE	1	54	22/Ø256-280		X224455	X224456
		10.2008	11.2013	ATE	1	54	25/Ø288-312		X224619	X224620
		10.2008	11.2013	ATE	1	57	30/Ø340		X224741	X224742
		10.2008	11.2013	BOSCH	1	38	10		X275065	X275066
		10.2008	11.2013	GIRL-TRW	1	38	10/Ø253		X375293	X375294
		10.2008	11.2013	GIRL-TRW	1	38	12/Ø282		X375377	X375378
		10.2008	11.2013	GIRL-TRW	1	41	12/Ø282		X375313	X375314
		10.2008	11.2013	GIRL-TRW	1	41	22		X375379	X375380

Affectations par Marques

Vehicule application - Zuordnung nach Marke und Fahrzeuge - Applicazione per marca e veicolo - Aplicacion por marca y vehiculo



VOLKSWAGEN



GOLF VII (5G, BE, BA)

Tout / All / Alle / Tutti / Todos		08.2012		GIRL-TRW	1	57	25/Ø288		X374777	X374778
		08.2012		GIRL-TRW	1	57	25/Ø312		X374759	X374760
		08.2012		GIRL-TRW	1	60	30/Ø340		X374781	X374782
		08.2012		ATE	1	38	10/Ø272		X227001	X227002
		08.2012		ATE	1	38	12/Ø300		X227003	X227004
		08.2012		ATE	1	42	22/Ø310		X227005	X227006

GOLF VII SPORTSVAN

Tout / All / Alle / Tutti / Todos		02.2014		GIRL-TRW	1	57	25/Ø288		X374777	X374778
		02.2014		GIRL-TRW	1	57	25/Ø312		X374759	X374760
		02.2014		ATE	1	38	10/Ø272		X227001	X227002

JETTA I (16)

Tout / All / Alle / Tutti / Todos		08.1978	02.1984	ATE	1	44	10		X224115	X224116
		08.1978	02.1984	ATE	1	44	12		X224375	X224376
		08.1978	02.1984	GIRL-TRW	2	44	10		X374073	X374074
		08.1978	02.1984	GIRL-TRW	2	44	12		X374063	X374064
		08.1978	02.1984	VW	1	48	12		X734001	X734002

JETTA II (19E, 1G2, 165)

Tout / All / Alle / Tutti / Todos		08.1983	12.1992	GIRL-TRW	1	54	20		X374037	X374038
		08.1983	12.1992	VW	1	48	10		X734003	X734004
		08.1983	12.1992	VW	1	48	12		X734001	X734002
		08.1983	12.1992	VW	1	48	12		X734007	X734008
		08.1983	12.1992	GIRL-TRW	1	36	10	#ID: 183_ / 245_	X375025	X375026
		08.1983	12.1992	GIRL-TRW	1	38	10	#ID: 272_	X375031	X375032

JETTA III (1H2)

1.9 TD		11.1991	09.1998	GIRL-TRW	1	54	13		X374205	X374206
		11.1991	09.1998	GIRL-TRW	1	54	20		X374037	X374038
		11.1991	09.1998	VW	1	48	12		X734007	X734008
		11.1991	09.1998	GIRL-TRW	1	38	10		X375123	X375124
2.0		11.1991	09.1998	ATE	1	54	25		X224249	X224250
		11.1991	09.1998	GIRL-TRW	1	54	20		X374037	X374038
		11.1991	09.1998	GIRL-TRW	1	54	22		X374151	X374152
		11.1991	09.1998	GIRL-TRW	1	38	10	#ID: 2728 2729	X375031	X375032
		11.1991	09.1998	GIRL-TRW	1	38	10	#ID: 443_ / 725_	X375123	X375124
2.0 GL		05.1996	12.1997	GIRL-TRW	1	54	20		X374037	X374038
		05.1996	12.1997	GIRL-TRW	1	38	10	#ID: 2728 2729	X375031	X375032
		05.1996	12.1997	GIRL-TRW	1	38	10	#ID: 443_ / 725_	X375123	X375124
2.8 VR6		08.1995	04.1996	ATE	1	54	25		X224249	X224250
		08.1995	04.1996	GIRL-TRW	1	54	22		X374151	X374152
		08.1995	04.1996	GIRL-TRW	1	38	10	#ID: 2728 2729	X375031	X375032
		08.1995	04.1996	GIRL-TRW	1	38	10	#ID: 443_ / 725_	X375123	X375124

Affectations par Marques

Vehicule application - Zuordnung nach Marke und Fahrzeuge - Applicazione per marca e veicolo - Aplicacion por marca y vehiculo



VOLKSWAGEN



JETTA IV (162, 163)

Tout / All / Alle / Tutti / Todos		04.2010		ATE	1	54	22/Ø256 -280		X224455	X224456
		04.2010		ATE	1	54	25/Ø288 -312		X224619	X224620
		04.2010		BOSCH	1	38	10/Ø272		X275065	X275066
		04.2010		GIRL-TRW	1	38	10/Ø253		X375293	X375294

JETTA IV (1J, 9M2)

Tout / All / Alle / Tutti / Todos		10.1998	05.2005	ATE	1	54	22/Ø256 -280		X224455	X224456
		10.1998	05.2005	ATE	1	54	25/Ø312		X224249	X224250
		10.1998	05.2005	GIRL-TRW	1	38	10	451 / 452	X375293	X375294
		10.1998	05.2005	GIRL-TRW	1	38	22		X375255	X375256
		10.1998	05.2005	GIRL-TRW	1	41	9	Ø=3 #ID: 313 314	X375191	X375192
		10.1998	05.2005	GIRL-TRW	1	41	9	Ø=6 #ID: 313 314	X375193	X375194

JETTA V (1K)

Tout / All / Alle / Tutti / Todos		08.2005	10.2010	ATE	1	54	22/Ø256 -280		X224455	X224456
		08.2005	10.2010	ATE	1	54	25/Ø288 -312		X224619	X224620
		08.2005	10.2010	BOSCH	1	38	10/Ø272		X275065	X275066
		08.2005	10.2010	GIRL-TRW	1	38	12/Ø282		X375377	X375378
		08.2005	10.2010	GIRL-TRW	1	41	12/Ø282		X375313	X375314

LOAD UP

Tout / All / Alle / Tutti / Todos		12.2014		ATE	1	54	22/Ø256 -280		X224455	X224456
-----------------------------------	--	---------	--	-----	---	----	-----------------	--	---------	---------

LT 28-35 I (281-363)

Tout / All / Alle / Tutti / Todos		04.1975	06.1996	ATE	2	57	20	ABS	X224113	X224114
		04.1975	06.1996	ATE	2	57	20	ABS	X224447	X224448

LT 28-35 II (2DB, 2DE, 2DK)

Tout / All / Alle / Tutti / Todos		05.1996	07.2006	ATE	1	60	22		X224489	X224490
		05.1996	07.2006	BOSCH	2	45	22		X274061	X274062
		05.1996	07.2006	PERROT	2	44	22		X614009	X614010
		05.1996	07.2006	ATE	1	45	12		X225211	X225212
		05.1996	07.2006	ATE	1	52	16		X225133	X225134
		05.1996	07.2006	BOSCH	1	52	16		X275001	X275002

LT 28-46 II (2DA,2DC, 2DD, 2DG, 2DL, 2DH)

Tout / All / Alle / Tutti / Todos		05.1996	07.2006	ATE	1	60	22		X224489	X224490
		05.1996	07.2006	BOSCH	2	45	22		X274061	X274062
		05.1996	07.2006	PERROT	2	44	22		X614009	X614010
		05.1996	07.2006	ATE	1	45	12		X225211	X225212
		05.1996	07.2006	ATE	1	52	16		X225133	X225134
		05.1996	07.2006	BOSCH	1	52	16		X275001	X275002

LT 40-55 I (291-293-512-909)

Tout / All / Alle / Tutti / Todos		04.1975	06.1996	ATE	2	57	20	ABS	X224113	X224114
		04.1975	06.1996	ATE	2	57	20		X224177	X224178
		04.1975	06.1996	ATE	2	57	20	ABS	X224479	X224480

Affectations par Marques

Vehicule application - Zuordnung nach Marke und Fahrzeuge - Applicazione per marca e veicolo - Aplicacion por marca y vehiculo



VOLKSWAGEN



LUPO (6X1, 6E1)

1.2 TDI 3L		07.1999	07.2005	ATE	-	48	15		X224631	X224632
		07.1999	07.2005	GIRL-TRW	1	34	9		X375253	X375254
1.6 GTI		09.2000	07.2005	GIRL-TRW	1	54	25		X374521	X374522
		09.2000	07.2005	GIRL-TRW	1	34	9		X375253	X375254
Tout / All / Alle / Tutti / Todos		09.1998	07.2005	BENDIX	1	48	18		X254213	X254214
		09.1998	07.2005	GIRL-TRW	1	54	20		X374409	X374410
		09.1998	07.2005	GIRL-TRW	1	34	9		X375253	X375254

MULTIVAN V (7HM, 7HN, 7HF, 7EF, 7EM, 7EN)

Tout / All / Alle / Tutti / Todos		04.2003	11.2015	ATE	1	60	29,5/Ø308		X224627	X224628
		04.2003	11.2015	ATE	1	60	32,5/Ø333		X224721	X224722
		04.2003	11.2015	ATE	1	44	22		X225355	X225356
		04.2003	11.2015	GIRL-TRW	1	41	13,5		X375315	X375316

MULTIVAN VI (SG_)

Tout / All / Alle / Tutti / Todos		04.2003	04.2015	ATE	1	60	29,5/Ø308		X224627	X224628
		04.2003	04.2015	GIRL-TRW	1	41	13,5		X375315	X375316

NEW BEETLE (1Y7) Décapotable

Tout / All / Alle / Tutti / Todos		09.2002	10.2010	ATE	1	54	22/Ø256-280		X224455	X224456
		09.2002	10.2010	ATE	1	54	25/Ø288-312		X224249	X224250
		09.2002	10.2010	GIRL-TRW	1	38	9		X375275	X375276

NEW BEETLE (9C1, 1C1)

Tout / All / Alle / Tutti / Todos		01.1998	09.2010	ATE	1	54	22/Ø256-280		X224455	X224456
		01.1998	09.2010	ATE	1	54	25/Ø288-312		X224249	X224250
		01.1998	09.2010	GIRL-TRW	1	38	22		X375255	X375256
		01.1998	09.2010	GIRL-TRW	1	38	9/Ø232		X375143	X375144
		01.1998	09.2010	GIRL-TRW	1	38	9/Ø232		X375275	X375276

PASSAT I (32 / 33)

Tout / All / Alle / Tutti / Todos		05.1973	07.1980	ATE	1	44	10		X224067	X224068	
		05.1973	07.1980	ATE	1	44	12		X224111	X224112	
		05.1973	07.1980	ATE	1	48	12		X224403	X224404	
		05.1973	07.1980	GIRL-TRW	1	48	12		Auto.	X374081	X374082
		05.1973	07.1980	GIRL-TRW	2	44	10		X374051	X374052	
		05.1973	07.1980	GIRL-TRW	2	44	12		X374337	X374338	
		05.1973	07.1980	VW	1	48	12		X734001	X734002	
		05.1973	07.1980	VW	1	48	12		X734007	X734008	

Affectations par Marques

Vehicule application - Zuordnung nach Marke und Fahrzeuge - Applicazione per marca e veicolo - Aplicacion por marca y vehiculo



VOLKSWAGEN



PASSAT II (32B / 33B)

Tout / All / Alle / Tutti / Todos

	08.1980	03.1988	ATE	1	44	10		X224115	X224116
	08.1980	03.1988	ATE	1	48	12		X224401	X224402
	08.1980	03.1988	ATE	1	48	12		X224403	X224404
	08.1980	03.1988	GIRL-TRW	1	54	20		X374037	X374038
	08.1980	03.1988	GIRL-TRW	1	54	20		X374038	X374037
	08.1980	03.1988	VW	1	48	12		X734001	X734002
	08.1980	03.1988	VW	1	48	12		X734007	X734008
	08.1980	03.1988	GIRL-TRW	1	36	10		X375025	X375026
	08.1980	03.1988	GIRL-TRW	1	38	10		X375031	X375032

PASSAT III (3A, 35I)

Tout / All / Alle / Tutti / Todos

	02.1988	08.1996	ATE	1	54	25/Ø288-312		X224249	X224250
	02.1988	08.1996	GIRL-TRW	1	54	20		X374037	X374038
	02.1988	08.1996	GIRL-TRW	1	54	22		X374133	X374134
	02.1988	08.1996	VW	1	48	12		X734001	X734002
	02.1988	08.1996	VW	1	48	12		X734007	X734008
	02.1988	08.1996	GIRL-TRW	1	38	10	#ID: 2728 2729	X375031	X375032
	02.1988	08.1996	GIRL-TRW	1	38	10	#ID: 443_ / 725_	X375123	X375124
	02.1988	08.1996	GIRL-TRW	1	38	10	#ID: 443_ / 725_	X375141	X375142

PASSAT IV (3B)

Tout / All / Alle / Tutti / Todos

	08.1996	12.2005	ATE	1	57	25		X224433	X224434
	08.1996	12.2005	ATE	1	57	25		X224833	X224834
	08.1996	12.2005	GIRL-TRW	1	54	22		X374435	X374436
	08.1996	12.2005	GIRL-TRW	2	43	30		X374609	X374610
	08.1996	12.2005	GIRL-TRW	1	38	10	#ID: 843 844	X375203	X375204
	08.1996	12.2005	GIRL-TRW	1	38	10	#ID: 877 878	X375165	X375166
	08.1996	12.2005	GIRL-TRW	1	43	22		X375309	X375310

PASSAT V (357) CC

Tout / All / Alle / Tutti / Todos

	05.2008	01.2012	ATE	1	54	25/Ø288-312		X224619	X224620
	05.2008	01.2012	ATE	1	57	25-30/Ø345		X224725	X224726
	05.2008	01.2012	GIRL-TRW	1	38	12	Fe	X377001	X377002
	05.2008	01.2012	GIRL-TRW	1	38	12	Al	X377039	X377040

PASSAT V (3C)

Tout / All / Alle / Tutti / Todos

	08.2005	11.2010	ATE	1	54	25/Ø288-312		X224619	X224620
	08.2005	11.2010	ATE	1	57	25-30/Ø345		X224725	X224726
	08.2005	11.2010	GIRL-TRW	1	38	12	Al	X377039	X377040
	08.2005	11.2010	GIRL-TRW	1	38	12	Al	X377003	X377004
	08.2005	11.2010	GIRL-TRW	1	38	12	Fe	X377001	X377002
	08.2005	11.2010	GIRL-TRW	1	41	22	Al	X377005	X377006

PASSAT VI (36_) VARIANT

Tout / All / Alle / Tutti / Todos

	08.2010	12.2014	ATE	1	54	25/Ø288-312	#ID: 581 582	X224619	X224620
	08.2010	12.2014	GIRL-TRW	1	38	12	Fe	X377001	X377002

X=1 : SNRA - X=2 : EAI - X=3 : SERA - X=4 : SEEAC - X=5 : NEOTO - X=6 : STARTCAR

Affectations par Marques

Vehicule application - Zuordnung nach Marke und Fahrzeuge - Applicazione per marca e veicolo - Aplicacion por marca y vehiculo



VOLKSWAGEN



PASSAT VII (3G)

Tout / All / Alle / Tutti / Todos		08.2014		GIRL-TRW	1	57	25/Ø312		X374759	X374760
		08.2014		ATE	1	42	12		X227007	X227008

PHAETON (3D_)

Tout / All / Alle / Tutti / Todos		04.2002	03.2016	ATE	2	42	34/Ø360		X224737	X224738
		04.2002	03.2016	GIRL-TRW	1	43	22		X375339	X375340

POLO I (86)

Tout / All / Alle / Tutti / Todos		03.1975	09.1981	ATE	1	44	8		X224091	X224092
-----------------------------------	--	---------	---------	-----	---	----	---	--	---------	---------

POLO II (86C, 80)

Tout / All / Alle / Tutti / Todos		10.1981	02.1985	ATE	1	44	10		X224115	X224116
		10.1981	09.1994	ATE	1	44	8		X224091	X224092
		03.1985	09.1994	VW	1	48	10		X734003	X734004
		01.1987	09.1994	VW	1	48	12		X734001	X734002

POLO II (86CF) TRANSFER

Tout / All / Alle / Tutti / Todos		08.1992	07.1994	BENDIX	1	48	10		X254203	X254204
		08.1992	07.1994	BENDIX	1	48	18		X254205	X254206
		08.1992	07.1994	VW	1	48	10		X734003	X734004

POLO III (6N)

Tout / All / Alle / Tutti / Todos		10.1994	09.2001	ATE	1	48	20		X224453	X224454
		10.1994	09.2001	BENDIX	1	48	10		X254203	X254204
		10.1994	09.2001	BENDIX	1	48	18		X254205	X254206
		10.1994	09.2001	BENDIX	1	48	18		X254213	X254214
		10.1994	09.2001	GIRL-TRW	1	54	20		X374409	X374410
		10.1994	09.2001	GIRL-TRW	1	54	25		X374521	X374522
		10.1994	09.2001	VW	1	48	10		X734003	X734004
		10.1994	09.2001	VW	1	48	12		X734007	X734008
		10.1994	09.2001	GIRL-TRW	1	34	9		X375253	X375254
		10.1994	09.2001	GIRL-TRW	1	38	10		X375123	X375124
		10.1994	09.2001	GIRL-TRW	1	38	10		X375141	X375142

POLO III (6V5) Classic/Estate/Flight

Tout / All / Alle / Tutti / Todos		05.1997	09.2001	ATE	1	48	20	ABS	X224453	X224454
		05.1997	09.2001	ATE	1	48	20	ABS	X224493	X224494
		05.1997	09.2001	GIRL-TRW	1	54	20		X374037	X374038
		05.1997	09.2001	VW	1	48	10		X734003	X734004
		05.1997	09.2001	VW	1	48	12		X734007	X734008
		05.1997	09.2001	GIRL-TRW	1	38	9		X375143	X375144

POLO IV (9N_)

1.8 GTI		09.2005	11.2009	ATE	1	54	25		X224249	X224250
		09.2005	11.2009	BENDIX	1	48	18		X254213	X254214
		09.2005	11.2009	GIRL-TRW	1	54	25		X374615	X374616
		09.2005	11.2009	GIRL-TRW	1	34	9		X375299	X375300

Affectations par Marques

Vehicule application - Zuordnung nach Marke und Fahrzeuge - Applicazione per marca e veicolo - Aplicacion por marca y vehiculo



VOLKSWAGEN



POLO IV (9N_)

Tout / All / Alle / Tutti / Todos		10.2001	01.2012	ATE	1	54	22		X224455	X224456
		10.2001	01.2012	BENDIX	1	48	18		X254213	X254214
		10.2001	01.2012	GIRL-TRW	1	54	25		X374615	X374616
		10.2001	01.2012	GIRL-TRW	1	34	9		X375299	X375300

POLO V (6R, 6C)

Tout / All / Alle / Tutti / Todos		01.2009		ATE	1	54	22/Ø256 ~280		X224455	X224456
		01.2009		ATE	1	54	25/Ø288 ~312		X224619	X224620
		01.2009		GIRL-TRW	1	38	22		X375255	X375256
		01.2009		GIRL-TRW	1	38	9		X375275	X375276

SANTANA (32B)

Tout / All / Alle / Tutti / Todos		08.1981	11.1983	ATE	1	48	12		X224401	X224402
		12.1983	12.1984	ATE	1	48	12		X224403	X224404

SCIROCCO I (53)

Tout / All / Alle / Tutti / Todos		02.1974	07.1980	ATE	1	44	12		X224375	X224376
		02.1974	07.1980	GIRL-TRW	2	44	10		X374051	X374052
		02.1974	07.1980	VW	1	48	12		X734001	X734002
		02.1974	07.1980	VW	1	48	12		X734007	X734008
		08.1975	07.1980	ATE	1	44	20		X224131	X224132

SCIROCCO II (53B)

1.8 16V		10.1985	07.1989	GIRL-TRW	1	54	20		X374037	X374038
		10.1985	07.1989	GIRL-TRW	1	36	10		X375025	X375026
Tout / All / Alle / Tutti / Todos		08.1982	07.1991	VW	1	48	12		X734007	X734008
		08.1983	07.1984	VW	1	48	12		X734001	X734002

SCIROCCO III (137, 138)

Tout / All / Alle / Tutti / Todos		05.2008		ATE	1	54	25/Ø288 ~312		X224619	X224620
		05.2008		ATE	1	57	30/Ø340		X224741	X224742
		05.2008		BOSCH	1	38	10/Ø272		X275065	X275066
		05.2008		GIRL-TRW	1	38	10/Ø253		X375293	X375294
		05.2008		GIRL-TRW	1	41	12/Ø282		X375313	X375314
		05.2008		GIRL-TRW	1	41	22		X375379	X375380

SHARAN I (7M)

Tout / All / Alle / Tutti / Todos		09.1995	03.2010	ATE	1	57	25/Ø288		X224449	X224450
		09.1995	03.2010	ATE	1	57	26/Ø300	#ID: 811 812	X224559	X224560
		09.1995	03.2010	ATE	1	57	26/Ø313	#ID: 819 820	X224633	X224634
		09.1995	03.2010	GIRL-TRW	1	38	10/Ø226 ~232	#ID: 443_ / 725_	X375123	X375124
		09.1995	03.2010	GIRL-TRW	1	38	10/Ø226 ~232	#ID: 443_ / 725_	X375141	X375142
		09.1995	03.2010	GIRL-TRW	1	38	13,5/Ø294	#ID: 6263	X375153	X375154

SHARAN II (7N)

Tout / All / Alle / Tutti / Todos		05.2010		ATE	1	57	25		X224819	X224820
		05.2010		GIRL-TRW	1	38	12		X377001	X377002

Affectations par Marques

Vehicule application - Zuordnung nach Marke und Fahrzeuge - Applicazione per marca e veicolo - Aplicacion por marca y vehiculo



VOLKSWAGEN



TARO

Tout / All / Alle / Tutti / Todos		04.1989	03.1997	ASCO	1	60	25		2WD	X194005	X194006
		04.1989	03.1997	SUMITOMO	4	43	20		4WD	X644055	X644056

TIGUAN I (5N_)

Tout / All / Alle / Tutti / Todos		09.2007		ATE	1	57	25			X224819	X224820
		09.2007		GIRL-TRW	1	38	12			X377001	X377002

TIGUAN II (AD1)

Tout / All / Alle / Tutti / Todos		01.2016		ATE	1	42	12		PR : 1KU	X227007	X227008
-----------------------------------	--	---------	--	-----	---	----	----	--	----------	---------	---------

TOUAREG I (7L)

Tout / All / Alle / Tutti / Todos		10.2002	05.2010	ATE	1	60	30			X224627	X224628
		10.2002	05.2010	BREMBO	4	46	32			X284123	X284124
		10.2002	05.2010	BREMBO	6	30/34/38	34			X284089	X284090
		10.2002	05.2010	BREMBO	6	34/36/38	32			X284107	X284108
		10.2002	05.2010	BREMBO	6	36	36/Ø368			X284161	X284162
		10.2002	05.2010	ATE	1	44	22			X225321	X225322
		10.2002	05.2010	BREMBO	2	44	28			X285061	X285062
		10.2002	05.2010	BREMBO	4	28/30	28/Ø330			X285063	X285064
		10.2002	05.2010	BREMBO	4	30	28/Ø358			X285073	X285074

TOUAREG II (7P5)

Tout / All / Alle / Tutti / Todos		01.2010		BREMBO	4	46	32			X284123	X284124
-----------------------------------	--	---------	--	--------	---	----	----	--	--	---------	---------

TOURAN (1T1, 1T2)

Tout / All / Alle / Tutti / Todos		02.2003	05.2010	ATE	1	54	25			X224619	X224620
		02.2003	05.2010	BOSCH	1	38	10			X275065	X275066
		02.2003	05.2010	GIRL-TRW	1	41	12			X375313	X375314

TOURAN (1T3)

Tout / All / Alle / Tutti / Todos		05.2010	05.2015	ATE	1	54	25			X224619	X224620
		05.2010	05.2015	BOSCH	1	38	10			X275065	X275066
		05.2010	05.2015	GIRL-TRW	1	41	12			X375313	X375314

TOURAN (5T1)

Tout / All / Alle / Tutti / Todos		05.2015		GIRL-TRW	1	57	25/Ø312			X374759	X374760
		05.2015		ATE	1	42	12			X227007	X227008

TRANSPORTER II

Tout / All / Alle / Tutti / Todos		08.1967	07.1972	ATE	2	54	13			X224043	X224044
		08.1967	04.1979	GIRL-TRW	2	54	13			X374055	X374056
		08.1972	04.1979	ATE	2	54	13			X224065	X224066

TRANSPORTER III

Tout / All / Alle / Tutti / Todos		05.1979	05.1986	ATE	2	54	13			X224065	X224066
		05.1979	07.1992	GIRL-TRW	1	60	15/Ø258			X374147	X374148
		05.1979	07.1992	GIRL-TRW	2	54	13/Ø278			X374091	X374092
		06.1986	08.1988	ATE	2	54	13			X224155	X224156
		09.1988	07.1992	ATE	1	60	15			X224193	X224194

X=1 : SNRA - X=2 : EAI - X=3 : SERA - X=4 : SEEC - X=5 : NEOTO - X=6 : STARTCAR

Affectations par Marques

Vehicule application - Zuordnung nach Marke und Fahrzeuge - Applicazione per marca e veicolo - Aplicacion por marca y vehiculo



VOLKSWAGEN



TRANSPORTER IV (70X_)

Tout / All / Alle / Tutti / Todos		07.1990	04.2003	ATE	1	57	24/Ø280		15"	X224483	X224484
		07.1990	04.2003	ATE	1	57	26/Ø313		16"	X224485	X224486
		07.1990	04.2003	ATE	1	57	26/Ø313		16"	X224633	X224634
		07.1990	04.2003	GIRL-TRW	1	54	16/Ø260		14"	X374145	X374146
		07.1990	04.2003	GIRL-TRW	1	54	18/Ø282		15"	X374391	X374392
		07.1990	04.2003	GIRL-TRW	1	54	24/Ø280		15"	X374263	X374264
		07.1990	04.2003	GIRL-TRW	1	38	12/Ø280		15"	X375151	X375152
		07.1990	04.2003	GIRL-TRW	1	38	13,5/Ø294		16"	X375153	X375154

TRANSPORTER V (7H_, 7J_)

Tout / All / Alle / Tutti / Todos		04.2003	08.2015	ATE	1	60	29,5/Ø308		16"	X224627	X224628
		04.2003	08.2015	ATE	1	60	32,5/Ø333		17"	X224721	X224722
		04.2003	08.2015	ATE	1	44	22		15"/17"	X225355	X225356
		04.2003	08.2015	GIRL-TRW	1	41	13,5		16"/17"	X375315	X375316

TRANSPORTER VI (SG_, SF_)

Tout / All / Alle / Tutti / Todos		04.2015		ATE	1	60	30/Ø308			X224627	X224628
		04.2015		GIRL-TRW	1	41	22/Ø294			X375315	X375316

UP

Tout / All / Alle / Tutti / Todos		08.2011		ATE	1	54	22/Ø256 ~280			X224455	X224456
-----------------------------------	--	---------	--	-----	---	----	-----------------	--	--	---------	---------

VENTO (1H2)

1.4		11.1991	07.1995	VW	1	48	12			X734001	X734002
		11.1991	07.1995	VW	1	48	12			X734007	X734008
		11.1991	07.1995	GIRL-TRW	1	38	10		#ID: 2728 2729	X375031	X375032
		11.1991	07.1995	GIRL-TRW	1	38	10/Ø226 ~232		ID:443 / 725	X375123	X375124
		11.1991	09.1998	GIRL-TRW	1	38	10/Ø226 ~232		ID:443 / 725	X375141	X375142
1.6		09.1992	07.1996	GIRL-TRW	1	54	13			X374205	X374206
		09.1992	09.1998	GIRL-TRW	1	54	20			X374037	X374038
		09.1992	12.1997	VW	1	48	12			X734001	X734002
		09.1992	12.1997	VW	1	48	12			X734007	X734008
		09.1992	09.1998	GIRL-TRW	1	38	10/Ø226 ~232		ID:443 / 725	X375141	X375142
		09.1992	12.1997	GIRL-TRW	1	38	10/Ø226 ~232		ID:443 / 725	X375123	X375124
1.8		11.1991	09.1998	ATE	1	48	20			X224453	X224454
		11.1991	07.1997	GIRL-TRW	1	54	20			X374037	X374038
		11.1991	12.1997	VW	1	48	12			X734001	X734002
		11.1991	12.1997	VW	1	48	12			X734007	X734008
		11.1991	12.1997	GIRL-TRW	1	38	10		#ID: 2728 2729	X375031	X375032
		11.1991	09.1998	GIRL-TRW	1	38	10/Ø226 ~232		ID:443 / 725	X375141	X375142
		11.1991	12.1997	GIRL-TRW	1	38	10/Ø226 ~232		ID:443 / 725	X375123	X375124

Affectations par Marques

Vehicule application - Zuordnung nach Marke und Fahrzeuge - Applicazione per marca e veicolo - Aplicacion por marca y vehiculo



VOLKSWAGEN



VENTO (1H2)											
1.9 D		11.1991	09.1998	ATE	1	48	20			X224453	X224454
		11.1991	07.1996	VW	1	48	12			X734001	X734002
		11.1991	07.1996	VW	1	48	12			X734007	X734008
		11.1991	12.1997	GIRL-TRW	1	38	10		#ID: 2728 2729	X375031	X375032
		11.1991	09.1998	GIRL-TRW	1	38	10/Ø226-232		Fe ID:443 / 725	X375141	X375142
		11.1991	12.1997	GIRL-TRW	1	38	10/Ø226-232		Fe ID:443 / 725	X375123	X375124
1.9 SDI		04.1997	12.1997	ATE	1	48	20			X224453	X224454
		04.1997	09.1998	VW	1	48	12			X734007	X734008
		04.1997	12.1997	GIRL-TRW	1	38	10		#ID: 2728 2729	X375031	X375032
		04.1997	09.1998	GIRL-TRW	1	38	10/Ø226-232		Fe ID:443 / 725	X375141	X375142
		04.1997	12.1997	GIRL-TRW	1	38	10/Ø226-232		Fe ID:443 / 725	X375123	X375124
1.9 TD		11.1991	12.1997	GIRL-TRW	1	54	20			X374037	X374038
		11.1991	09.1998	GIRL-TRW	1	38	10/Ø226-232		Fe ID:443 / 725	X375141	X375142
		11.1991	12.1997	GIRL-TRW	1	38	10/Ø226-232		Fe ID:443 / 725	X375123	X375124
1.9 TDI		09.1993	12.1997	GIRL-TRW	1	54	20			X374037	X374038
		09.1993	09.1998	GIRL-TRW	1	38	10/Ø226-232		Fe ID:443 / 725	X375141	X375142
		09.1993	12.1997	GIRL-TRW	1	38	10/Ø226-232		Fe ID:443 / 725	X375123	X375124
2.0		11.1991	12.1997	GIRL-TRW	1	54	20			X374037	X374038
		11.1991	12.1997	GIRL-TRW	1	38	10		#ID: 2728 2729	X375031	X375032
		11.1991	09.1998	GIRL-TRW	1	38	10/Ø226-232		Fe ID:443 / 725	X375141	X375142
2.8 VR6		11.1991	12.1997	GIRL-TRW	1	38	10/Ø226-232		Fe ID:443 / 725	X375123	X375124
		01.1992	12.1997	GIRL-TRW	1	54	22			X374151	X374152
		01.1992	12.1997	GIRL-TRW	1	38	10		#ID: 2728 2729	X375031	X375032
		01.1992	09.1998	GIRL-TRW	1	38	10/Ø226-232		Fe ID:443 / 725	X375141	X375142
		01.1992	12.1997	GIRL-TRW	1	38	10/Ø226-232		Fe ID:443 / 725	X375123	X375124



VOLVO



66											
Tout / All / Alle / Tutti / Todos		01.1972	12.1980	ATE	2	44	11			X224101	X224102
140 (142, 144, 145)											
Tout / All / Alle / Tutti / Todos		08.1966	08.1975	ATE	4	36	12,7			X224053	X224054
		08.1966	08.1975	GIRL-TRW	4	36	12,7			X374019	X374020
		08.1966	08.1975	ATE	2	38	9,6			X225021	X225022
		08.1966	08.1975	GIRL-TRW	2	36	9,6			X375001	X375002
		08.1966	08.1975	GIRL-TRW	2	38	9,6			X375009	X375010
164											
Tout / All / Alle / Tutti / Todos		09.1968	12.1971	GIRL-TRW	4	36	12,7			X374019	X374020
		01.1969	12.1975	ATE	4	36	12,7			X224053	X224054
		07.1971	12.1975	ATE	4	36	24			X224055	X224056
		01.1969	12.1975	ATE	2	38	9,6			X225021	X225022
		09.1969	08.1970	GIRL-TRW	2	36	9,6			X375001	X375002
		09.1970	12.1975	GIRL-TRW	2	38	9,6			X375009	X375010

X=1 : SNRA - X=2 : EAI - X=3 : SERA - X=4 : SEEAC - X=5 : NEOTO - X=6 : STARTCAR

Affectations par Marques

Vehicule application - Zuordnung nach Marke und Fahrzeuge - Applicazione per marca e veicolo - Aplicacion por marca y vehiculo



VOLVO



121 - 122 - 123 AMAZON

Tout / All / Alle / Tutti / Todos		06.1964	08.1968	GIRL-TRW	3	38/54	12,7		X374033	X374034
		09.1968	12.1970	GIRL-TRW	4	36	12,7		X374019	X374020

240 (P242, P244, P245)

Tout / All / Alle / Tutti / Todos		08.1974	12.1993	ATE	4	36	14,3		X224119	X224120
		08.1974	12.1993	ATE	4	36	24		X224121	X224122
		08.1974	12.1993	GIRL-TRW	4	36	14,3		X374093	X374094
		08.1974	12.1993	GIRL-TRW	4	38	14,3		X374103	X374104
		08.1974	12.1993	GIRL-TRW	4	38	22		X374113	X374114
		08.1974	12.1993	GIRL-TRW	4	38	22		X374177	X374178
		08.1974	12.1993	ATE	2	38	9,6		X225039	X225040
		08.1974	12.1993	GIRL-TRW	2	38	9,6		X375019	X375020

260 (P262, P264, P265)

Tout / All / Alle / Tutti / Todos		08.1974	07.1982	ATE	4	36	14,5		X224119	X224120
		08.1974	07.1982	ATE	4	36	24		X224121	X224122
		08.1974	07.1982	GIRL-TRW	4	36	14,5		X374093	X374094
		08.1974	07.1982	GIRL-TRW	4	38	14,5		X374103	X374104
		08.1974	07.1982	GIRL-TRW	4	38	22	ABS	X374113	X374114
		08.1974	07.1982	GIRL-TRW	4	38	22	ABS	X374177	X374178
		08.1974	07.1982	ATE	2	38	9,6		X225039	X225040
		08.1974	07.1982	ATE	2	38	9,6		X225193	X225194
		08.1974	07.1982	GIRL-TRW	2	38	9,6		X375019	X375020

340 - 360 (343, 344, 345)

Tout / All / Alle / Tutti / Todos		08.1975	07.1991	GIRL-TRW	1	48	12,7		X374095	X374096
		08.1975	07.1991	GIRL-TRW	2	48	10		X374105	X374106

440 K (445)

Tout / All / Alle / Tutti / Todos		08.1988	12.1996	ATE	1	54	22		X224419	X224420
		08.1988	12.1996	GIRL-TRW	1	54	12	->EKC6386	X374001	X374002
		08.1988	12.1996	GIRL-TRW	1	54	12	EKC6387->	X374101	X374102
		08.1988	12.1996	ATE	1	33	9		X225001	X225002

460 L (464)

Tout / All / Alle / Tutti / Todos		09.1988	07.1996	ATE	1	54	22		X224419	X224420
		09.1988	07.1996	GIRL-TRW	1	54	12		X374101	X374102
		09.1988	07.1996	ATE	1	33	9		X225001	X225002

480 E

Tout / All / Alle / Tutti / Todos		04.1986	07.1996	ATE	1	54	22		X224419	X224420
		04.1986	07.1996	GIRL-TRW	1	54	12	->EKC538520	X374001	X374002
		04.1986	07.1996	GIRL-TRW	1	54	12	EKC538521->	X374101	X374102
		04.1986	07.1996	ATE	1	33	9		X225001	X225002

Affectations par Marques

Vehicule application - Zuordnung nach Marke und Fahrzeuge - Applicazione per marca e veicolo - Aplicacion por marca y vehiculo



VOLVO



740 - 760 (704, 744, 745, 764, 765)

Tout / All / Alle / Tutti / Todos		01.1982	08.1992	BENDIX	2	40	22	ABS	X254019	X254020
		01.1982	08.1992	BENDIX	2	40	22	ABS	X254069	X254070
		01.1982	08.1992	BENDIX	2	40	22	ABS	X254173	X254174
		01.1982	08.1992	BENDIX	2	40	22	ABS	X254201	X254202
		01.1982	08.1992	GIRL-TRW	1	57	26	ABS	X374143	X374144
		01.1982	08.1992	GIRL-TRW	2	40	14	ABS	X374345	X374346
		01.1982	08.1992	GIRL-TRW	2	40	22	ABS	X374109	X374110
		01.1982	08.1992	GIRL-TRW	2	40	22	ABS	X374111	X374112
		01.1982	08.1992	ATE	2	34	9,6		X225119	X225120
		01.1982	08.1992	ATE	2	36	9,6	NO noisereduction noisereduction	X225015	X225016
		01.1982	08.1992	ATE	2	36	9,6		X225289	X225290
		01.1982	08.1992	ATE	2	38	9,6	NO noisereduction noisereduction	X225045	X225046
		01.1982	08.1992	ATE	2	38	9,6		X225291	X225292
		01.1982	08.1992	ATE	2	40	9,6	NO noisereduction noisereduction	X225065	X225066
		01.1982	08.1992	ATE	2	40	9,6		X225293	X225294
		01.1982	08.1992	GIRL-TRW	1	38	10		X375029	X375030

780

Tout / All / Alle / Tutti / Todos		04.1986	11.1990	BENDIX	2	40	22		X254069	X254070
		04.1986	11.1990	GIRL-TRW	1	57	26	ABS	X374143	X374144
		04.1986	11.1990	GIRL-TRW	2	40	22	ABS	X374111	X374112
		04.1986	11.1990	ATE	2	36	9,6		X225015	X225016
		04.1986	11.1990	ATE	2	38	9,6		X225045	X225046
		04.1986	11.1990	ATE	2	40	9,6		X225065	X225066
		04.1986	11.1990	GIRL-TRW	1	38	9,6		X375029	X375030

850 (L_)

2.3 T5-R		04.1996	12.1996	ATE	1	57	26		X224303	X224304
		04.1996	12.1996	ATE	2	38	9,6		X225089	X225090
		04.1996	12.1996	GIRL-TRW	1	40	10		X375065	X375066
2.4 AWD Break		04.1996	12.1996	ATE	1	57	26		X224303	X224304
		04.1996	12.1996	GIRL-TRW	1	40	10		X375065	X375066
Tout / All / Alle / Tutti / Todos		06.1991	12.1996	ATE	1	57	26		X224303	X224304
		06.1991	12.1996	ATE	2	38	9,6		X225071	X225072

940 I - 960 I (944, 945, 964, 965)

2.3 Turbo		08.1991	07.1993	BENDIX	2	40	22		X254019	X254020
		08.1991	07.1993	GIRL-TRW	1	57	26		X374143	X374144
		08.1991	07.1993	GIRL-TRW	2	40	22	ABS	X374109	X374110
		08.1991	07.1993	GIRL-TRW	2	40	22	ABS	X374111	X374112

Affectations par Marques

Vehicule application - Zuordnung nach Marke und Fahrzeuge - Applicazione per marca e veicolo - Aplicacion por marca y vehiculo



VOLVO



940 I - 960 I (944, 945, 964, 965)

Tout / All / Alle / Tutti / Todos		08.1990	12.1994	BENDIX	2	40	22		X254019	X254020
		08.1990	12.1994	BENDIX	2	40	22		X254201	X254202
		08.1990	12.1994	GIRL-TRW	1	57	26	ABS	X374143	X374144
		08.1990	12.1994	GIRL-TRW	2	40	22	ABS	X374109	X374110
		08.1990	12.1994	ATE	2	36	9,6		X225289	X225290
		08.1990	12.1994	ATE	2	38	9,6		X225045	X225046
		08.1990	12.1994	ATE	2	38	9,6		X225291	X225292
		08.1990	12.1994	ATE	2	40	9,6		X225065	X225066
		08.1990	12.1994	ATE	2	40	9,6		X225293	X225294
		08.1990	12.1994	GIRL-TRW	1	38	10		X375029	X375030
		08.1990	12.1994	GIRL-TRW	1	40	10		X375065	X375066

940 II - 960 II (944, 945, 964, 965)

Tout / All / Alle / Tutti / Todos		07.1994	10.1998	GIRL-TRW	1	57	26		X374143	X374144
		07.1994	10.1998	ATE	2	36	9,6		X225289	X225290
		07.1994	10.1998	ATE	2	38	9,6		X225291	X225292
		07.1994	10.1998	ATE	2	40	9,6		X225065	X225066
		07.1994	10.1998	ATE	2	40	9,6		X225293	X225294
		07.1994	10.1998	GIRL-TRW	1	40	10		X375065	X375066

C30

Tout / All / Alle / Tutti / Todos		10.2006	12.2013	ATE	1	57	25		X224601	X224602
		10.2006	12.2013	ATE	1	38	11	#ID: 949 950	X225445	X225446
		10.2006	12.2013	ATE	1	38	11	#ID: 987 988	X225281	X225282

C70 I

Tout / All / Alle / Tutti / Todos		03.1997	10.2005	ATE	1	57	26		X224303	X224304
		03.1997	10.2005	ATE	2	38	9,6		X225071	X225072

C70 II

Tout / All / Alle / Tutti / Todos		03.2006	06.2013	ATE	1	57	25/Ø278 -300		X224601	X224602
		03.2006	06.2013	ATE	1	57	25/Ø320		X224683	X224684
		03.2006	06.2013	ATE	1	38	11	->77106	X225281	X225282
		03.2006	06.2013	ATE	1	38	11	77107->	X225445	X225446

P 122 S AMAZON

Tout / All / Alle / Tutti / Todos		05.1959	05.1971	GIRL-TRW	3	38/54	12,7		X374033	X374034
-----------------------------------	--	---------	---------	----------	---	-------	------	--	---------	---------

S40 I (VS)

Tout / All / Alle / Tutti / Todos		09.1995	12.1997	GIRL-TRW	1	54	24/Ø256		X374401	X374402
		09.1995	12.2003	GIRL-TRW	1	54	24/Ø281		X374419	X374420
		09.1995	12.1997	GIRL-TRW	1	38	10		X375147	X375148
		09.1995	12.2003	GIRL-TRW	1	38	10		X375233	X375234

Affectations par Marques

Vehicule application - Zuordnung nach Marke und Fahrzeuge - Applicazione per marca e veicolo - Aplicacion por marca y vehiculo



VOLVO



S40 II (MS)

Tout / All / Alle / Tutti / Todos		01.2004	12.2012	ATE	1	57	25/Ø278-300		X224601	X224602
		01.2004	12.2012	ATE	1	57	25/Ø320		X224683	X224684
		01.2004	12.2012	ATE	1	38	11	#ID: 949 950	X225445	X225446
		01.2004	12.2012	ATE	1	38	11	#ID: 987 988	X225281	X225282

S60 I

Tout / All / Alle / Tutti / Todos		07.2000	04.2010	ATE	1	57	28/Ø320		X224689	X224690
		07.2000	04.2010	ATE	1	60	28/Ø305		X224565	X224566
		07.2000	04.2010	ATE	1	60	28/Ø316		X224691	X224692
		07.2000	04.2010	BREMBO	4	38/42	32		X284151	X284152
		07.2000	04.2010	ATE	1	42	12		X225265	X225266
		07.2000	04.2010	BREMBO	4	28/30	28		X285071	X285072

S60 II

Tout / All / Alle / Tutti / Todos		04.2010		ATE	1	60	28/Ø300		X224663	X224664
		04.2010		ATE	1	60	28/Ø316		X224713	X224714
		04.2010		ATE	1	60	28/Ø336		X224715	X224716
		04.2010		GIRL-TRW	1	38	11		X377041	X377042
		04.2010		GIRL-TRW	1	41	22		X377033	X377034

S70 (LS)

Tout / All / Alle / Tutti / Todos		11.1996	11.2000	ATE	1	57	26/Ø280		X224303	X224304
		11.1996	11.2000	ATE	1	60	28/Ø305		X224565	X224566
		11.1996	11.2000	ATE	1	42	12		X225265	X225266
		11.1996	11.2000	ATE	2	38	10		X225071	X225072
		11.1996	11.2000	GIRL-TRW	1	40	10		X375065	X375066

S80 I (TS, XY)

Tout / All / Alle / Tutti / Todos		05.1998	07.2006	ATE	1	57	28/Ø320		X224689	X224690
		05.1998	07.2006	ATE	1	60	28/Ø305		X224565	X224566
		05.1998	07.2006	ATE	1	42	12		X225265	X225266

S80 II (AS)

Tout / All / Alle / Tutti / Todos		03.2006		ATE	1	60	28/Ø300		X224663	X224664
		03.2006		ATE	1	60	28/Ø316		X224713	X224714
		03.2006		ATE	1	60	28/Ø336		X224715	X224716
		03.2006		GIRL-TRW	1	38	11		X377041	X377042
		03.2006		GIRL-TRW	1	38	18		X375357	X375358
		03.2006		GIRL-TRW	1	41	22		X377033	X377034

S90 I

Tout / All / Alle / Tutti / Todos		11.1996	12.1998	GIRL-TRW	1	57	26		X374143	X374144
		11.1996	12.1998	GIRL-TRW	1	38	10		X375029	X375030

Affectations par Marques

Vehicule application - Zuordnung nach Marke und Fahrzeuge - Applicazione per marca e veicolo - Aplicacion por marca y vehiculo



VOLVO



V40 I (VW) Break

Tout / All / Alle / Tutti / Todos		07.1995	06.2004	GIRL-TRW	1	54	24/Ø256		X374401	X374402
		07.1995	06.2004	GIRL-TRW	1	54	24/Ø281		X374419	X374420
		07.1995	06.2004	GIRL-TRW	1	38	10		X375147	X375148
		07.1995	06.2004	GIRL-TRW	1	38	10		X375233	X375234

V40 II

Tout / All / Alle / Tutti / Todos		03.2012		ATE	1	57	25/Ø278 -300		X224601	X224602
		03.2012		ATE	1	57	25/Ø320		X224683	X224684
		03.2012		ATE	1	38	11		X225445	X225446

V50 (MW)

Tout / All / Alle / Tutti / Todos		12.2003	12.2012	ATE	1	57	25/Ø278 -300		X224601	X224602
		12.2003	12.2012	ATE	1	57	25/Ø320		X224683	X224684
		12.2003	12.2012	ATE	1	38	11	#ID: 949 950	X225445	X225446
		12.2003	12.2012	ATE	1	38	11	#ID: 987 988	X225281	X225282

V60

Tout / All / Alle / Tutti / Todos		07.2010		ATE	1	60	28/Ø300		X224663	X224664
		07.2010		ATE	1	60	28/Ø316		X224713	X224714
		07.2010		ATE	1	60	28/Ø336		X224715	X224716
		07.2010		GIRL-TRW	1	38	11		X377041	X377042
		07.2010		GIRL-TRW	1	41	22		X377033	X377034

V70 I (LV)

Tout / All / Alle / Tutti / Todos		12.1995	12.2000	ATE	1	57	26		X224303	X224304
		12.1995	12.2000	ATE	2	38	9,6		X225071	X225072
		12.1995	12.2000	GIRL-TRW	1	40	10		X375065	X375066

V70 II (SW)

Tout / All / Alle / Tutti / Todos		11.1999	12.2008	ATE	1	57	28/Ø320		X224689	X224690
		11.1999	12.2008	ATE	1	60	28/Ø305		X224565	X224566
		11.1999	12.2008	BREMBO	4	38/42	32		X284151	X284152
		11.1999	12.2008	ATE	1	42	12		X225265	X225266
		11.1999	12.2008	BREMBO	4	28/30	28		X285071	X285072

V70 III (BW)

Tout / All / Alle / Tutti / Todos		04.2007		ATE	1	60	28/Ø300		X224663	X224664
		04.2007		ATE	1	60	28/Ø316		X224713	X224714
		04.2007		ATE	1	60	28/Ø336		X224715	X224716
		04.2007		GIRL-TRW	1	38	11		X377041	X377042
		04.2007		GIRL-TRW	1	41	22		X377033	X377034

Affectations par Marques

Vehicule application - Zuordnung nach Marke und Fahrzeuge - Applicazione per marca e veicolo - Aplicacion por marca y vehiculo



VOLVO



V70 XC

Tout / All / Alle / Tutti / Todos		10.1997	08.2007	ATE	1	57	26/Ø280		X224303	X224304
		10.1997	08.2007	ATE	1	57	28/Ø320		X224689	X224690
		10.1997	08.2007	ATE	1	60	28/Ø305		X224565	X224566
		10.1997	08.2007	ATE	1	40	12		X225381	X225382
		10.1997	08.2007	ATE	1	42	12		X225265	X225266
		10.1997	08.2007	GIRL-TRW	1	40	10		X375065	X375066

V90 I Break

Tout / All / Alle / Tutti / Todos		11.1996	12.1998	GIRL-TRW	1	57	26	ABS	X374143	X374144
		11.1996	12.1998	GIRL-TRW	1	38	10		X375029	X375030

XC60 I

Tout / All / Alle / Tutti / Todos		05.2008	12.2016	ATE	2	44	30		X224875	X224876
		05.2008	12.2016	GIRL-TRW	1	38	11		X377041	X377042
		05.2008	12.2016	GIRL-TRW	1	41	22		X377033	X377034

XC70 I CROSS COUNTRY

Tout / All / Alle / Tutti / Todos		11.1997	08.2007	ATE	1	57	28/Ø320		X224689	X224690
		11.1997	08.2007	ATE	1	60	28/Ø286-305		X224565	X224566
		11.1997	08.2007	ATE	1	42	12		X225265	X225266

XC70 II

Tout / All / Alle / Tutti / Todos		04.2007		ATE	1	60	28/Ø300		X224663	X224664
		04.2007		ATE	1	60	28/Ø316		X224713	X224714
		04.2007		ATE	1	60	28/Ø336		X224715	X224716
		04.2007		GIRL-TRW	1	38	11		X377041	X377042
		04.2007		GIRL-TRW	1	41	22		X377033	X377034

XC90

2.5 T		10.2002	12.2014	ATE	1	60	28		X224637	X224638
		10.2002	12.2014	ATE	1	60	28/Ø316		X224691	X224692
3.2 AWD		05.2006		ATE	1	60	28		X224637	X224638
		05.2006		ATE	1	60	28/Ø316		X224691	X224692
D3 / D5		04.2009		ATE	1	60	28		X224637	X224638
		04.2009		ATE	1	60	28/Ø316		X224691	X224692
D5		10.2002	12.2014	ATE	1	60	28		X224637	X224638
		10.2002	12.2014	ATE	1	60	28/Ø316		X224691	X224692
D5 AWD		10.2007		ATE	1	60	28		X224637	X224638
		10.2007		ATE	1	60	28/Ø316		X224691	X224692
T6		10.2002	08.2005	ATE	1	60	28		X224637	X224638
		10.2002	08.2005	ATE	1	60	28/Ø316		X224691	X224692
Tout / All / Alle / Tutti / Todos		10.2002		ATE	1	44	20		X225325	X225326
		10.2007		ATE	1	44	20		X225325	X225326
V8		01.2005	12.2014	ATE	1	60	28		X224637	X224638
		01.2005	12.2014	ATE	1	60	28/Ø316		X224691	X224692

Affectations par Marques

Vehicule application - Zuordnung nach Marke und Fahrzeuge - Applicazione per marca e veicolo - Aplicacion por marca y vehiculo



WARTBURG

353

Tout / All / Alle / Tutti / Todos		04.1969	09.1988	PAL	4	34	9		X604001	X604002
-----------------------------------	--	---------	---------	-----	---	----	---	--	---------	---------



ZASTAVA



101 (1100/1300)

Tout / All / Alle / Tutti / Todos		01.1972	12.1977	BENDIX	1	48	10		X254023	X254024
-----------------------------------	--	---------	---------	--------	---	----	----	--	---------	---------

YUGO

Tout / All / Alle / Tutti / Todos		01.1984	06.1995	BENDIX	1	48	10		X254023	X254024
-----------------------------------	--	---------	---------	--------	---	----	----	--	---------	---------

YUGO FLORIDA

Tout / All / Alle / Tutti / Todos		01.1984	11.2008	BENDIX	1	48	10		X254023	X254024
		01.1984	11.2008	GIRL-TRW	1	48	10		X374277	X374278



Références d'origine Etrier

O.E.M. - OE Nummern - Codigos originales - Codici originali

ALFA ROMEO		ALFA ROMEO		ALFA ROMEO		ALFA ROMEO		AUDI		AUDI	
102004	X585004	9948469	X224476	60743084	X255059	77365616	X224852	443615124	X374038	441615107C	X224467
510404	X225032	9948470	X224476	60743084	X375035	77365739	X375437	443615407	X225013	441615108A	X224468
510405	X225031	9948544	X375247	60743085	X255032	77365741	X375438	443615408	X225014	441615108B	X374386
530712	X224076	9948547	X375248	60743085	X255060	77365743	X375437	443615423	X375003	441615108C	X224468
530713	X224075	9948795	X224476	60743085	X375036	77365745	X375438	443615424	X375004	443615107A	X224191
542213	X224007	9948858	X375145	60743418	X374188	77366146	X284189	447615123	X374041	443615107B	X224167
542214	X224008	9948860	X375146	60743419	X374187	77366147	X284190	447615124	X374042	443615107C	X224181
705569	X254127	9948862	X375145	60743571	X374292	77366434	X284189	447615423	X375023	443615108A	X224192
705570	X254128	9948863	X224476	60743572	X374291	77366435	X284190	447615423	X375132	443615108B	X224168
794180	X374343	9948899	X375247	60744116	X225032	735455837	X274071	447615424	X375024	443615108C	X224182
794181	X374344	9948901	X375248	60744117	X225031	735455838	X274072	803615107	X224410	443615123A	X374037
794182	X374343	9949522	X375247	60745065	X224076	735457083	X224475	803615108	X224409	443615123A	X374133
794183	X374344	9949523	X375248	60745066	X224075	735457084	X224476	811615123	X374081	443615123B	X224189
9448124	X224475	9950437	X375033	60747122	X225031	735474003	X274035	811615124	X374082	443615123C	X224191
9939501	X375035	9950438	X375034	60747123	X225032	735474004	X274036	853615423	X375021	443615123D	X224167
9939502	X255032	9950477	X375033	60747124	X224075	4773026080	X375046	853615424	X375022	443615123E	X224181
9940213	X375045	9950478	X375034	60747125	X224076	105142205203	X224089	857615123	X374133	443615123F	X374133
9940214	X375046	9950553	X224285	60749879	X254127	105142205203	X224362	857615124	X374134	443615124A	X374038
9940618	X374427	9950558	X374268	60749880	X254128	105142205303	X224090	857615423	X375027	443615124A	X374134
9940622	X374428	9950559	X224286	60750962	X255032	105142205303	X224361	893615107	X224167	443615124B	X224190
9941666	X375033	9950605	X224286	60755049	X254128	105262600300	X225127	893615108	X224168	443615124C	X224192
9941667	X375034	9950644	X224286	60755050	X254127	105262600301	X225127	893615123	X374038	443615124D	X224168
9941948	X374427	9950644	X374268	60760111	X374343	105262600400	X225128	893615124	X374037	443615124E	X224182
9941949	X374428	9950646	X224286	60760112	X374344	105262600401	X225128	895615123	X374193	443615124F	X374134
9942902	X375033	9950709	X375033	60760115	X375045	105412205200	X224362	895615124	X374194	443615423A	X375005
9942903	X375034	9950709	X375083	60760116	X255032	105412205300	X224361	1A8615123	X374192	443615423AX	X375005
9944493	X375033	9950710	X375034	60760116	X375046	105482600301	X225127	1A8615124	X374191	443615423AX	X375063
9944497	X375034	9950710	X375084	60765013	X374269	105482600401	X225128	1H0615423D	X375123	443615424A	X375006
9944721	X374211	9950784	X375034	60765014	X374270	113102205201	X284006	1H0615424D	X375124	443615424AX	X375006
9944723	X374212	9950805	X224283	77362676	X284153	113102205301	X284005	1J0615123	X224455	443615424AX	X375064
9944784	X375034	9950806	X224283	77362677	X284154	113152205200	X284006	1J0615123A	X224455	443615424X	X375004
9945582	X375033	9950808	X224284	77363536	X284155	113152205299	X284006	1J0615124	X224456	447615123A	X224469
9945584	X375034	9950809	X224284	77363537	X284156	113152205300	X284005	1J0615124A	X224456	447615124A	X224470
9946116	X374267	9950859	X375145	77363587	X224666	113152205399	X284005	1J0615423	X375143	4A0615107	X374385
9946893	X374267	9950863	X375146	77363648	X375349	113522205201	X224162	1J0615423C	X375313	4A0615107A	X374765
9947128	X224285	9950866	X375033	77363649	X375350	113522205301	X224161	1J0615423E	X375255	4A0615108	X374386
9947129	X224286	9950871	X375034	77363651	X375399	116332600300	X225009	1J0615423F	X375275	4A0615108A	X374766
9947391	X224285	9951096	X224603	77363652	X375400	116332600399	X225009	1J0615424	X375144	4A0615123	X224239
9947392	X224286	9951099	X224604	77363686	X224665	116332600400	X225010	1J0615424C	X375314	4A0615123A	X224241
9947426	X375083	9951213	X375247	77364538	X375247	116412600400	X225010	1J0615424E	X375256	4A0615124	X224240
9947427	X375084	9951214	X375248	77364540	X375248	116412600499	X225010	1K0615123G	X224725	4A0615124A	X224242
9947428	X375083	9978465	X375145	77364745	X375247	116462205200	X224100	1K0615123J	X224725	4A0615423	X375063
9947429	X375084	46522343	X224473	77364747	X375248	116462205300	X224099	1K0615123M	X224619	4A0615423X	X375063
9947613	X375084	46522344	X224474	77364755	X374645	116502205201	X224090	1K0615124G	X224726	4A0615424	X375064
9947614	X375083	46522345	X224475	77364757	X374646	116502205299	X224090	1K0615124J	X224726	4A0615424X	X375064
9947615	X375084	46522346	X224476	77364768	X224475	116502205301	X224089	1K0615124M	X224620	4B0615107	X374757
9947815	X375289	51877192	X375455	77364769	X224476	116502205399	X224089	1K0615423A	X375293	4B0615107A	X374609
9947816	X375290	51877193	X375456	77364818	X375145	116992205200	X224162	1K0615423G	X375379	4B0615107B	X374609
9947849	X284115	51877199	X375453	77364820	X375146	116992205300	X224161	1K0615423H	X375313	4B0615108	X374758
9947850	X284116	51877200	X375454	77364978	X274071	116992600300	X225009	1K0615423L	X375377	4B0615108A	X374610
9947884	X375145	51884763	X224851	77364979	X274072	116992600400	X225010	1K0615423N	X375377	4B0615108B	X374610
9947885	X375145	51884764	X224852	77364982	X274035	117022205200	X224162	1K0615424A	X375294	4B0615123	X224834
9947895	X224476	60501456	X254127	77364983	X274036	117022205299	X224162	1K0615424G	X375380	4B0615123A	X224887
9947896	X375146	60501457	X254128	77364989	X275061	117022205300	X224161	1K0615424H	X375314	4B0615124	X224434
9948033	X284185	60501458	X254127	77364990	X275062	117022205399	X224161	1K0615424L	X375378	4B0615124A	X224888
9948035	X284186	60514987	X224231	77364991	X275061	119132205200	X224320	1K0615424N	X375378	4B0615424	X375310
9948123	X224473	60514989	X224232	77364992	X275062	119132205300	X224319	2E0615423A	X275039	4D0615107	X374407
9948124	X224473	60515390	X254128	77364998	X284187	119132600300	X225143	2E0615424A	X275040	4D0615107A	X374407
9948128	X224474	60562782	X375059	77364999	X284188	119132600400	X225144	2H0615123	X274111	4D0615107B	X374651
9948129	X224474	60562783	X375060	77365000	X284187	547808000000	X224232	2H0615124	X274112	4D0615108	X374408
9948204	X224603	60562784	X375061	77365001	X284188	547809000000	X224231	331615107B	X224111	4D0615108A	X374408
9948208	X224604	60562785	X375062	77365071	X224475			331615108B	X224112	4D0615108B	X374652
9948226	X224476	60565212	X374165	77365072	X224476			357615123A	X374037	4D0615423	X375139
9948227	X224476	60565213	X374166	77365484	X284190			3A0615123	X224249	4D0615423B	X375139
9948229	X224475	60565767	X374157	77365485	X284189			431615123A	X374137	4D0615423D	X375129
9948230	X224475	60565768	X374158	77365529	X375453			431615123A	X374138	4D0615423E	X375189
9948339	X284125	60580429	X374271	77365531	X375454			431615124A	X374138	4D0615424	X375140
9948340	X284186	60580430	X374272	77365536	X375455			433615123A	X374133	4D0615424B	X375140
9948413	X224473	60729254	X224090	77365537	X375456			433615124A	X374134	4D0615424D	X375049
9948414	X224474	60729256	X224089	77365611	X224853			437615423A	X375027	4D0615424E	X375190
9948465	X224475	60734814	X224162	77365614	X224854			441615107A	X224467	4E0615123	X224737
9948466	X224475	60734816	X224161	77365615	X224851			441615107B	X374385	4E0615403B	X377017

Références d'origine Etrier

O.E.M. - OE Nummern - Codigos originales - Codici originali

AUDI	
4E0615404B	X377018
4F0615123	X224749
4F0615124	X224750
4F0615403	X377015
4F0615403A	X377007
4F0615403C	X377007
4F0615403F	X377007
4F0615403K	X377057
4F0615404A	X377008
4F0615404D	X377016
4F0615404F	X377008
4F0615404K	X377058
4G0615123	X374733
4G0615123A	X374735
4G0615123B	X224857
4G0615123C	X374733
4G0615123D	X374735
4G0615123E	X224857
4G0615124	X374734
4G0615124A	X374736
4G0615124B	X224858
4G0615124C	X374734
4G0615124D	X374736
4G0615124E	X224858
4G0615403	X377043
4G0615403A	X377045
4G0615403B	X377049
4G0615403C	X377047
4G0615403F	X377045
4G0615404	X377044
4G0615404A	X377046
4G0615404B	X377050
4G0615404C	X377048
4G0615404F	X377046
4H0615403A	X377067
4H0615404A	X377068
6Q0615123A	X374615
6Q0615124A	X374616
6Q0615423B	X375299
6Q0615424B	X375300
701615124DX	X374392
7H0615123B	X224721
7H0615124B	X224722
7L6615123M	X284107
7L6615123N	X284089
7L6615123Q	X284089
7L6615123R	X284123
7L6615123S	X284161
7L6615123T	X284107
7L6615124M	X284108
7L6615124N	X284090
7L6615124Q	X284090
7L6615124R	X284124
7L6615124S	X284162
7L6615124T	X284108
7L6615149	X284089
7L6615150	X284090
7L6615423H	X285063
7L6615423K	X285073
7L6615423L	X285063
7L6615424H	X285064
7L6615424K	X285074
7L6615424L	X285064
7L8615423	X285095
7L8615423A	X285095
7L8615424	X285096
7L8615424A	X285096
7L9615123	X284161
7L9615124	X284162
7L9615403B	X285073
7L9615404B	X285074
7L9615423	X285073

AUDI	
7L9615424	X285074
7M0615123B	X224449
7M0615124C	X224450
803615105C	X224321
803615106C	X224322
853615423A	X375049
853615423A	X375130
853615423AX	X375049
853615423X	X375021
853615424A	X375129
853615424AX	X375129
853615424X	X375022
861615107C	X224091
861615108C	X224092
893615107A	X224181
893615107A	X224182
893615108A	X224181
893615108A	X224182
893615123A	X224167
893615123AX	X224167
893615123B	X224181
893615123B	X224182
893615124A	X224168
893615124AX	X224168
893615124B	X224181
893615124B	X224182
893915124A	X224168
895615123A	X374361
895615124A	X374362
8A0615123	X374037
8A0615123	X374191
8A0615124	X374192
8A0615423	X375047
8A0615423A	X375051
8A0615423AX	X375051
8A0615423X	X375047
8A0615424	X375048
8A0615424A	X375052
8A0615424AX	X375052
8A0615424X	X375048
8A0698680AX	X375051
8A0698680AX	X375052
8A0698680X	X375047
8A0698680X	X375048
8D0615123	X374383
8D0615123A	X224435
8D0615123B	X224433
8D0615123B	X224834
8D0615123X	X374383
8D0615124	X374384
8D0615124A	X224436
8D0615124B	X224434
8D0615124X	X374384
8D0615423	X375085
8D0615423A	X375087
8D0615423B	X375087
8D0615423C	X375415
8D0615424	X375086
8D0615424A	X375088
8D0615424B	X375088
8D0615424C	X375416
8E0615123A	X224433
8E0615124A	X224434
8E0615423A	X375203
8E0615423B	X375251
8E0615423C	X375391
8E0615423D	X375389
8E0615423G	X375251
8E0615423H	X375389
8E0615423J	X375391
8E0615424A	X375204
8E0615424B	X375252

AUDI	
8E0615424C	X375392
8E0615424D	X375390
8E0615424G	X375252
8E0615424H	X375390
8E0615424J	X375392
8J0615123A	X224619
8J0615423B	X375379
8J0615423C	X375377
8J0615423E	X375379
8J0615423F	X375377
8J0615424B	X375380
8J0615424C	X375378
8J0615424E	X375380
8J0615424F	X375378
8K0615123	X374675
8K0615123B	X374675
8K0615123D	X374735
8K0615123E	X374735
8K0615123F	X224785
8K0615123H	X374675
8K0615123J	X374735
8K0615124	X374676
8K0615124B	X374676
8K0615124D	X374736
8K0615124E	X374736
8K0615124F	X224786
8K0615124H	X374676
8K0615124J	X374736
8K0615403	X377063
8K0615403A	X377063
8K0615403B	X377027
8K0615404	X377064
8K0615404A	X377064
8K0615404B	X377028
8L0615123	X224249
8L0615124	X224250
8N0615123	X224249
8N0615124	X224250
8N0615423A	X375193
8N0615423B	X375255
8N0615423D	X375253
8N0615424A	X375194
8N0615424B	X375256
8N0615424D	X375254
8V0615123A	X374759
8V0615123D	X374759
8V0615124A	X374760
8V0615124D	X374760

AUSTIN

311851	X374349
311852	X374350
1500121	X275033
1504905	X275034
1504906	X275032
1504907	X275031
1595641	X224720
1595642	X224719
1625702	X224175
3195161	X374071
3195162	X374072
27H4650	X464037
27H4651	X464038
37H4265	X374320
37H4266	X374319
37H6125	X374024
37H6126	X374023
BAU4401	X374195
BAU4401	X374354
BAU4402	X374196
BAU4402	X374198
BAU4929	X374198
BAU4930	X374354

AUSTIN	
BAU5892	X464002
BAU5893	X464001
CAP5023	X464005
CAP5024	X464006
GBC131	X464002
GBC132	X464001
GBC133	X224312
GBC133	X464006
GBC134	X224311
GBC134	X464005
GBC138	X464025
GBC138	X464026
GBC141	X464025
GBC141	X464026
JLM782	X374375
JLM783	X374376
SEG000040	X224556
SEG000050	X224555
SOB000040	X225210
SOB000050	X225209

BMW

6753673	X225393
6753674	X225394
3421163394	X225170
34106786059	X284159
34106786060	X284160
3411101093	X224024
3411101094	X224023
3411101843	X224040
3411101844	X224039
3411101859	X224077
3411101860	X224078
3411115930	X224369
3411115931	X224370
3411115937	X224095
3411115938	X224096
3411117137	X224099
3411117138	X224100
3411117537	X374125
3411117538	X224096
3411117879	X224141
3411117880	X224142
3411118173	X224141
3411119021	X224137
3411119022	X224138
3411119080	X224142
3411119109	X224141
3411119110	X224142
34111120291	X224141
34111120292	X224142
34111120293	X224141
34111120294	X224142
34111150251	X224095
34111150252	X224096
34111150253	X224095
34111150254	X224096
34111150255	X224099
34111150256	X224100
34111150257	X224099
34111150258	X224100
34111150261	X374125
34111150262	X374126
34111150269	X224135
34111150270	X224136
34111150387	X224097
34111150388	X224098
34111151347	X224141
34111151348	X224142
34111151479	X224117
34111151480	X224118
34111151481	X224117
34111151482	X224118

BMW	
34111151577	X224157
34111151578	X224158
34111151579	X224157
34111151580	X224158
34111151581	X224169
34111151582	X224170
34111151583	X224169
34111151584	X224170
34111154039	X224159
34111154040	X224160
34111154041	X224159
34111154042	X224160
34111154377	X374015
34111154378	X374016
34111154379	X374017
34111154380	X374018
34111154607	X224169
34111154608	X224170
34111154609	X224169
34111154610	X224170
34111156655	X224199
34111156656	X224200
34111157389	X224097
34111157389	X224291
34111157390	X224098
34111157390	X224292
34111157495	X224207
34111157496	X224208
34111157501	X224219
34111157502	X224220
34111159775	X224459
34111159776	X224460
34111160325	X224205
34111160326	X224206
34111160345	X224261
34111160346	X224262
34111160351	X224263
34111160352	X224264
34111160361	X224207
34111160362	X224208
34111160363	X224097
34111160363	X224291
34111160364	X224098
34111160364	X224292
34111160367	X224219
34111160368	X224220
34111160369	X224159
34111160370	X224160
34111160373	X224169
34111160374	X224170
34111160375	X224157
34111160376	X224158
34111160379	X224199
34111160380	X224200
34111160939	X224291
34111160939	X224292
34111160940	X224291
34111160940	X224292
34111161177	X284013
34111161178	X284014
34111161691	X284057
34111161692	X284058
34111163303	X224441
34111163304	X224442
34111163317	X224499
34111163318	X224500
34111163385	X224443
34111163386	X224444
34111163643	X224441
34111163644	X224442
34111163757	X284057
34111163758	X284058

BMW	
34111165029	X224263
34111165030	X224264
34111165559	X224261
34111165560	X224262
34111166231	X224441
34111166232	X224442
34112225000	X224457
34112225001	X224458
34112225002	X224457
34112225003	X224458
34112225403	X224425
34112225404	X224426
34112226407	X224097
34112226408	X224098
34112226871	X224425
34112226872	X224426
34112226873	X224097
34112226873	X224291
34112226874	X224098
34112226874	X224292
34112227115	X224461
34112227116	X224462

Références d'origine Etrier

O.E.M. - OE Nummern - Codigos originales - Codici originali

BMW	
34116774681	X374619
34116774682	X374620
34116776527	X224803
34116776528	X224804
34116776783	X224811
34116776784	X224812
34116776785	X224823
34116776786	X224824
34116778145	X224753
34116778146	X224754
34116786741	X284159
34116786742	X284160
34116786817	X224773
34116786818	X224774
34116791919	X224769
34116791920	X224770
34116792689	X224771
34116792690	X224772
34116850649	X274129
34116850650	X274130
34211119087	X225043
34211119088	X225044
34211119211	X225033
34211119212	X225034
34211150265	X225151
34211150266	X225152
34211150275	X225153
34211150276	X224012
34211150276	X225154
34211151633	X225047
34211151634	X225048
34211151635	X225047
34211151636	X225048
34211151645	X225041
34211151646	X225042
34211153241	X225047
34211153242	X225048
34211153243	X225047
34211153244	X225048
34211154599	X225047
34211154600	X225048
34211154601	X225047
34211154602	X225048
34211154871	X225047
34211154872	X225048
34211154943	X225047
34211154944	X225048
34211155491	X225077
34211155492	X225078
34211155993	X225047
34211155994	X225048
34211156087	X225077
34211156088	X225078
34211156203	X225095
34211156204	X225096
34211157555	X225061
34211157556	X225062
34211157557	X225061
34211157558	X225062
34211157791	X225097
34211157792	X225098
34211157915	X225077
34211157916	X225078
34211160329	X225081
34211160330	X225082
34211160333	X225107
34211160333	X225253
34211160334	X225108
34211160334	X225254
34211160337	X225105
34211160338	X225106
34211160353	X225077

BMW	
34211160354	X225078
34211160381	X225061
34211160382	X225062
34211160391	X225103
34211160392	X225104
34211160393	X225097
34211160394	X225098
34211160397	X225047
34211160398	X225048
34211160399	X225101
34211160400	X225102
34211160437	X225101
34211160438	X225102
34211160441	X225097
34211160442	X225098
34211160927	X225099
34211160928	X225100
34211162437	X225177
34211162438	X225178
34211162933	X225175
34211162934	X225176
34211162939	X225173
34211162940	X225174
34211163321	X225179
34211163322	X225180
34211163333	X225189
34211163334	X225190
34211163393	X225169
34211163394	X225170
34211163649	X225167
34211163650	X225168
34211164187	X225283
34211164188	X225284
34211164397	X225267
34211164398	X225268
34211164579	X225179
34211164580	X225180
34211165031	X225217
34211165032	X225218
34211165033	X225209
34211165034	X225210
34211166235	X225307
34211166236	X225308
34212225409	X225077
34212225410	X225078
34212225446	X225077
34212225447	X225078
34212227509	X225093
34212227510	X225094
34212227519	X225171
34212227520	X225172
34212227873	X225181
34212227874	X225182
34212229703	X225365
34212229704	X225366
34212282195	X225419
34212282196	X225420
34212282857	X225421
34212282858	X225422
34212283163	X225309
34212283164	X225310
34212283164	X225435
34212283393	X225363
34212283394	X225364
34216750161	X225271
34216750162	X225272
34216751089	X225361
34216751090	X225362
34216753673	X225393
34216753674	X225394
34216753679	X225309

BMW	
34216753680	X225310
34216758057	X225323
34216758058	X225324
34216758127	X225217
34216758128	X225218
34216758135	X225209
34216758136	X225210
34216763729	X225315
34216763730	X225316
34216765883	X225271
34216765884	X225272
34216765909	X225375
34216765910	X225376
34216765911	X225363
34216765912	X225364
34216768191	X375325
34216768192	X375326
34216768423	X225361
34216768424	X225362
34216768443	X225307
34216768444	X225308
34216768693	X225335
34216768694	X225336
34216768697	X225367
34216768698	X225368
34216769101	X225353
34216769102	X225354
34216776377	X375325
34216776378	X375326
34216776787	X225399
34216776788	X225400
34216776789	X225433
34216776790	X225434
34216776925	X375411
34216776926	X375412
34216793047	X377037
34216793048	X377038
34216850857	X275079
34216850858	X275080
CHEVROLET	
13301189	X274105
13301190	X274106
13301226	X274107
13301227	X274108
13324900	X225405
13324901	X225406
13324902	X225405
13324903	X225406
13365454	X225405
13365455	X225406
13365456	X225405
13365457	X225406
13578741	X324021
13578754	X324022
94566890	X324009
94566891	X324010
96273700	X324003
96273701	X324004
96391880	X324001
96391881	X324002
96418871	X324001
96418872	X324002
96418879	X325005
96418880	X325006
96426039	X324013
96426039	X324015
96426040	X324014
96426040	X324016
96426041	X324015
96426042	X324016
96463798	X325005
96463799	X325006

CHEVROLET	
96475840	X325007
96475841	X325008
96489171	X325007
96489172	X325008
96549622	X325005
96549623	X325006
96549788	X324001
96549789	X324002
96626067	X484051
96626068	X484052
96639588	X324017
96639589	X324018
96682851	X324019
96682852	X324020
CHRYSLER	
4423466	X404001
4423466	X404009
4423467	X404002
4423467	X404010
4423716	X404004
4423716	X404008
4423717	X404003
4423717	X404007
4797566	X404005
4797567	X404006
05003891AB	X225247
05003981AB	X225248
05010032AA	X404006
05010033AA	X404005
05017832AA	X374618
05017833AA	X374617
05018206AA	X405002
05018207AA	X405001
05019806AA	X224593
05019807AA	X224594
05019808AA	X225247
05019808AA	X225248
05072218AA	X224678
05072219AA	X224677
05083158AA	X405002
05083159AA	X405001
05191238AA	X164318
05191239AA	X164317
05191267AA	X165193
05191268AA	X165194
5003891AB	X225247
5003891AB	X225248
5017832AA	X374618
5017833AA	X374617
5018206AA	X405002
5018207AA	X405001
5019806AA	X224593
5019807AA	X224594
5019808AA	X225247
5019808AA	X225248
5072218AA	X224678
5072218AB	X224678
5072219AA	X224677
5072219AB	X224677
5083158AA	X405002
5083159AA	X405001
5191238AA	X164318
5191239AA	X164317
5191267AA	X165193
5191268AA	X165194
68003697AA	X374729
68003697AC	X374729
68003707AA	X374730
68003707AC	X374730
68029848AA	X375452
68029848AB	X375452
68029848AC	X375452

CHRYSLER	
68029848AD	X375452
68029849AA	X375451
68029849AB	X375451
68029849AC	X375451
68029849AD	X375451
K05191238AA	X164318
K05191239AA	X164317
K05191267AA	X165193
K05191268AA	X165194
DACIA	
6001549800	X224847
6001549801	X224848
7711368116	X374631
7711368117	X374632
410014231R	X224848
410016069R	X224878
410018218R	X224818
410111495R	X224817
410118579R	X224877
410118909R	X224847
DAEWOO	
542242	X224196
9626488	X324011
86288627	X324003
93741027	X324003
93741028	X324004
94566890	X324009
94566891	X324010
96193089	X224045
96193090	X224046
96205944	X324011
96205945	X324012
96205954	X325009
96205955	X325010
96226977	X224195
96226978	X224196
96245167	X324011
96245168	X324012
96246689	X325009
96246690	X325010
96249284	X324001
96249285	X324002
96250029	X324001
96250030	X324002
96253375	X324011
96253376	X324012
96253377	X324011
96253378	X324012
96259766	X325001
96259767	X325002
96264688	X324011
96264689	X324012
96264948	X324007
96264949	X324008
96268460	X324001
96268461	X324002
96273700	X324005
96273701	X324006
96281933	X324007
96281934	X324008
96281935	X324003
96281935	X324005
96281936	X324004
96281936	X324006
96288627	X324013
96288627	X324015
96288628	X324004
96288628	X324014
96288628	X324016
96289796	X325009
96289797	X325010
96300320	X325001

DAEWOO	
96300321	X325002
96316580	X324003
96316580	X324013
96316580	X324015
96316600	X324004
96316600	X324014
96316600	X324016
96391880	X324001
96391881	X324002
96391888	X325001
96391888	X325003
96391889	X325002
96391889	X325004
96426039	X324003
96426040	X324004
96426041	X324003
96426041	X324013
96426042	X324004
96426042	X324014
96447107	X324011
96447108	X324012
96451643	X325001
96451644	X325002
96463798	X325005
96463799	X325006
96475840	X325007
96475841	X325008
96489168	X325007
96489169	X325008
96489171	X325007
96489172	X325008

Références d'origine Etrier

O.E.M. - OE Nummern - Codigos originales - Codici originali

DAIHATSU	
4773087707000	X164244
4773087708000	X164242
4775014070000	X164189
4775087602000	X164077
4775087603000	X164079
4775087606000	X164079
4775087607000	X164135
4775087608000	X164255
4775087701000	X164001
4775087705000	X164075
4775087706000	X164195
4775087707000	X164243
4775087708000	X164241
4781387701000	X525002
4782387701000	X525001
4783087101000	X525014
4783087701000	X525002
4783087702000	X525002
4783087703000	X525002
4783087704000	X165132
4784087101000	X525013
4784087701000	X525001
4784087702000	X525001
4784087703000	X525001
4784087704000	X165131
47710B1050	X674100
47710B1113	X674100
47720B1050	X674099
47720B1113	X674099
47730B1051	X674100
47730B2032	X674100
47750B1051	X674099
47750B2032	X674099
DAIMLER	
JLM20927	X374666
JLM20928	X374665
DODGE	
68020252AB	X165188
68020252AB	X165198
68020261AB	X165187
68020261AB	X165197
K68003774AA	X375436
K68003778AA	X375435
FIAT	
440086	X374014
790328	X254023
790329	X254024
790330	X254033
790331	X254034
790332	X254033
790333	X254034
790471	X255035
790472	X255036
790478	X255003
790478	X255035
790479	X255004
790479	X255036
790902	X374155
790903	X374156
790909	X254085
790909	X254093
790909	X254192
790910	X254086
790910	X254094
790910	X254191
791129	X374265
791130	X374266
791444	X374161
791445	X374157
791472	X374265
791473	X374266
791877	X374267

FIAT	
791878	X374268
791895	X255059
791896	X255060
791899	X255031
791900	X255032
791901	X255059
791902	X255060
792235	X374157
792236	X374158
792286	X254093
792287	X254094
792337	X255031
792337	X255059
792338	X255032
792338	X255060
793060	X374277
793061	X374278
793764	X374427
793765	X374428
793766	X374427
793767	X374428
793768	X374425
793769	X374426
793770	X374425
793771	X374426
793788	X255037
793789	X255038
793790	X255037
793791	X255038
795424	X374377
795425	X374378
795426	X374377
795427	X374378
1820282	X254146
1820283	X254145
1830766	X254145
1956422	X374394
4182500	X255036
4182501	X255035
4182795	X255004
4182796	X255003
4239314	X254024
4239315	X254024
4250728	X254033
4250729	X254034
4269406	X254033
4269407	X254034
4299772	X254024
4307039	X255035
4307040	X255036
4307043	X255003
4307044	X255004
4395658	X254024
4395659	X254023
5455898	X315014
5669002	X255003
5669003	X255004
5669008	X254033
5669009	X254034
5932725	X224405
5932726	X224406
5943640	X374161
5943641	X374162
7078619	X224544
7078620	X224543
7079192	X224531
7079192	X224545
7079193	X224532
7079193	X224546
7079757	X224532
7079758	X224531
7079761	X224543

FIAT	
7079762	X224544
7082145	X224531
7082145	X224545
7082167	X224532
7082167	X224546
7545165	X374159
7545166	X374160
7560322	X224287
7560323	X224288
7639043	X224287
7639044	X224288
7755710	X254145
7755711	X254146
7763618	X224597
7763619	X224598
9911552	X374178
9914106	X254146
9937780	X374012
9938112	X254037
9938113	X254038
9939501	X255031
9939501	X375035
9939502	X255032
9939502	X375036
9939698	X374013
9939699	X374014
9940066	X375101
9940069	X375102
9940213	X375045
9940214	X375046
9940618	X374427
9940622	X374428
9941666	X375033
9941667	X375034
9941948	X374165
9941948	X374427
9941949	X374166
9941949	X374428
9942902	X375033
9942903	X375034
9943827	X374277
9943828	X374278
9944493	X375033
9944497	X375034
9944608	X254146
9944618	X254145
9945582	X375033
9945584	X375034
9945736	X375083
9945737	X375084
9945781	X374223
9945782	X374224
9945796	X374227
9945797	X374228
9945798	X374229
9945799	X374230
9945800	X374229
9945801	X374230
9945804	X374231
9945805	X374232
9946009	X374293
9946012	X374294
9946102	X254145
9946103	X254145
9946106	X254146
9946107	X254146
9946161	X374265
9946163	X374266
9946180	X254086
9946180	X254094
9946182	X254085
9946182	X254093

FIAT	
9946228	X374397
9946229	X374398
9946230	X374397
9946231	X374398
9946618	X254145
9946640	X224288
9946641	X224287
9946828	X374267
9946829	X374268
9946890	X374265
9946891	X374266
9946898	X374161
9946899	X374157
9946899	X374161
9947017	X374161
9947018	X374157
9947018	X374161
9947047	X224431
9947048	X224432
9947049	X224431
9947050	X224432
9947059	X374157
9947060	X374158
9947119	X224283
9947120	X224284
9947121	X224283
9947122	X224284
9947126	X224285
9947127	X224286
9947128	X224285
9947129	X224286
9947391	X224285
9947392	X224286
9947426	X375083
9947427	X375084
9947612	X375083
9947613	X375084
9947815	X375289
9947816	X375290
9948100	X224533
9948101	X224533
9948102	X224534
9948103	X224534
9948106	X254145
9948107	X254145
9948109	X254146
9948110	X254146
9948204	X224603
9948208	X224604
9948471	X224476
9948538	X375345
9948539	X375345
9948540	X375346
9948544	X375247
9948547	X375248
9949336	X274031
9949342	X274032
9949344	X274033
9949346	X274034
9949348	X274035
9949351	X274036
9949353	X275017
9949359	X275018
9949413	X284045
9949414	X284046
9949415	X284047
9949416	X284048
9949421	X284029
9949422	X284030
9949423	X284049
9949424	X284050

FIAT	
9949427	X285031
9949428	X285032
9949538	X374589
9949539	X374590
9950277	X374165
9950278	X374166
9950437	X375033
9950438	X375034
9950477	X375033
9950478	X375034
9950589	X374265
9950592	X374266
9950602	X374267
9950603	X374268
9950643	X224285
9950644	X224286
9950645	X224285
9950646	X224286
9950709	X375033
9950709	X375083
9950710	X375034
9950710	X375084
9950866	X375033
9950871	X375034
9951096	X224603
9951099	X224604
9951213	X375247
9951214	X375248
20388410	X284001
20388420	X284002
42470847	X284021
42530360	X284079
42530361	X284080
42530362	X285037
42530363	X285038
42532364	X284033
42532365	X284034
42536172	X284021
42536173	X284022
42536174	X285037
42536175	X285038
42536624	X284021
42536625	X284022
42536626	X285037
42536627	X285038
42536628	X284037
42536629	X284038
42536630	X285021
42536631	X285022
42548187	X284021
42548188	X285022
42554758	X285051
42554759	X285052
42554785	X285051
42559617	X285021
42559618	X285022
46468090	X224531
46468090	X224545
46468091	X224532
46468091	X224546
46476232	X224543
46476233	X224544
46758648	X224895
46758649	X224896
51857257	X274072
51857258	X274071
51885201	X284094
51885309	X284118
51885310	X284096
51885311	X284098
55704022	X274071
55704023	X274072

FIAT	
60743084	X375035
60743085	X255032
60750962	X255032
60760115	X375045
60760116	X255032
60760116	X375046
71714554	X254146
71724252	X274083
71728817	X375291
71728818	X375292
71742847	X374716
71742848	X374715
71750079	X374716
71750080	X374715
71751548	X274080
71753241	X254146
71769990	X284093
71769991	X284117
71769992	X284095
71769993	X284097
71769995	X275051
71769996	X275052
71769997	X275051
71769998	X275052
71792216	X254145
71793080	X274083
71793083	X274084
71793156	X284093
71793157	X284093
71793158	X284093
71793159	X284094
71793160	X284094
71793161	X284094
71793162	X284117
71793163	X284117
71793164	X284117
71793165	X284118
71793166	X284118
71793167	X284118
71793168	X284095
71793169	X284095
71793170	X284095
71793171	X284096
71793172	X284096
71793173	X284096
71793174	X284097
71793175	X284097
71793176	X284097
71793177	X284098
71793178	X284098
71793179	X284098
71793180	X275051
71793181	X275051
71793183	X275052
71793184	X275052
71793185	X275052
71793317	

Références d'origine Etrier

O.E.M. - OE Nummern - Codigos originales - Codici originali

FIAT	
77363519	X275049
77363520	X275050
77363596	X224635
77363628	X374673
77363629	X374674
77363636	X375507
77363637	X375508
77363644	X375405
77363646	X375406
77363687	X224636
77363924	X274077
77363925	X274078
77363929	X274071
77363930	X274072
77363933	X274079
77363934	X274080
77363937	X275047
77363938	X275048
77364042	X284093
77364043	X284094
77364048	X284117
77364049	X284118
77364051	X284095
77364052	X284096
77364054	X284097
77364055	X284098
77364132	X275051
77364133	X275052
77364225	X224625
77364226	X224626
77364313	X375469
77364315	X375470
77364342	X375345
77364344	X375346
77364364	X274071
77364396	X274078
77364397	X274077
77364398	X274072
77364399	X274071
77364451	X285031
77364452	X285032
77364454	X284045
77364455	X284046
77364456	X284047
77364457	X284048
77364459	X284029
77364460	X284030
77364461	X284049
77364462	X284050
77364538	X375247
77364540	X375248
77364592	X375345
77364594	X375346
77364602	X275049
77364604	X275050
77364642	X275049
77364644	X275050
77364646	X274031
77364648	X274032
77364650	X274033
77364652	X274034
77364654	X274035
77364656	X274036
77364674	X254146
77364676	X254145
77364679	X274083
77364681	X274084
77364683	X274072
77364685	X274071
77364701	X375345
77364702	X375346
77364755	X374645

FIAT	
77364757	X374646
77364822	X374699
77364825	X374700
77364841	X254145
77364842	X254146
77364910	X224533
77364911	X224534
77364917	X224432
77364918	X224431
77364921	X224283
77364922	X224284
77364966	X224851
77364967	X224852
77365008	X274079
77365009	X274080
77365114	X275049
77365115	X275050
77365138	X274071
77365140	X274072
77365170	X375469
77365171	X375470
77365309	X224851
77365310	X224852
77365453	X275047
77365454	X275048
77365460	X275047
77365461	X275048
77365544	X274072
77365545	X274072
77365554	X274080
77365555	X274080
77365748	X375345
77365749	X375346
77365750	X375345
77365751	X375346
77365758	X224855
77365759	X224856
77365935	X284098
77365977	X284118
77365978	X284094
77366174	X375345
77366175	X375346
77366178	X274071
77366179	X274072
82365081	X374161
82365082	X374157
93802698	X464004
93802699	X464003
95609790	X374013
95609791	X374014
99477119	X224283
464776233	X224543
504120969	X285051
711787000	X224432
711788000	X224431
711789000	X224284
711790000	X224283
711791000	X224286
711792000	X224285
7114952000	X224544
7114953000	X224543
717223000	X375084
717229000	X375083
717230000	X375084
720169000	X224532
720169000	X224546
720170000	X224531
720170000	X224545
720418000	X224543
720419000	X224544
735245204	X224896
735249500	X254145

FIAT	
735249501	X254146
735249786	X224543
735249787	X224544
735256337	X224895
735283425	X224531
735283425	X224545
735283426	X224532
735283426	X224546
735287453	X274031
735287454	X274032
735289101	X284045
735289102	X284046
735289103	X284047
735289104	X284048
735289105	X284029
735289106	X284030
735289107	X284049
735289108	X284050
735289109	X285031
735289110	X285032
735322960	X284095
735322961	X284096
735322962	X284097
735322963	X284098
735330269	X274031
735330270	X274032
735350351	X224635
735350352	X224636
735353854	X275051
735353855	X275052
735353856	X284117
735353857	X284118
735353858	X284093
735353859	X284094
735353870	X275051
735353871	X275052
735361976	X284045
735361977	X284046
735361978	X284047
735361979	X284048
735361980	X284029
735361981	X284030
735361982	X284049
735361983	X284050
735364069	X375405
735364070	X375406
735364071	X375507
735364072	X375508
735414678	X374673
735414679	X374674
735414699	X375507
735414700	X375508
735419201	X224625
735419202	X224626
735468861	X274079
735480254	X274071
735480255	X274072
735483694	X374673
735483695	X374674
735483698	X375507
735483699	X375508
753289101	X284045
775353858	X284093
775374968	X374673
775374969	X374674
775386507	X274071
775386508	X274072
1334622080	X374589
1334623080	X374590
1607731680	X374663
1607731780	X374664
4773026080	X375046

FIAT	
9404401928	X374293
9404401938	X374294
9464216180	X375291
9464216280	X375292
9467566980	X374661
9467567080	X374662
511079J00	X375341
9467567580	X375342
9467578080	X374663
9467578180	X374664
9567477080	X254207
9567477180	X254208
511079J00	X374716
512079J00	X374715
CAP5309	X464003
CAP5310	X464004
K68003697AA	X374729
K68003697AC	X374729
K68003707AA	X374730
K68003707AC	X374730
FORD	
460915	X224090
460916	X224089
706836	X224384
706837	X224383
706870	X224326
706871	X224325
1001959	X375124
1001959	X375142
1001960	X375123
1001960	X375141
1007814	X224216
1007818	X224477
1007819	X224478
1007821	X224215
1044227	X255040
1044229	X255068
1044230	X255068
1044234	X255039
1044237	X255067
1044239	X255067
1048296	X254108
1048298	X254107
1049936	X224450
1049937	X224449
1072759	X224272
1072951	X224272
1072953	X224271
1072959	X224272
1072961	X224271
1075553	X375156
1075554	X375155
1075560	X224496
1075789	X224495
1106150	X224572
1106151	X224571
1109020	X375154
1109021	X375153
1110240	X224634
1110252	X224633
1118406	X255040
1118408	X255039
1121374	X224216
1121375	X224215
1121377	X224216
1121379	X224215
1121380	X224478
1121381	X224477
1121752	X224424
1121753	X224272
1121757	X224423
1121758	X224271

FORD	
1121821	X275016
1121850	X275015
1123892	X274046
1123895	X274045
1124880	X224574
1124881	X224573
1125861	X375012
1125862	X375011
1126286	X224572
1126290	X224574
1126291	X224571
1126292	X224573
1126716	X274046
1126717	X274045
1126962	X275020
1130121	X275019
1133215	X275020
1133216	X275019
1138582	X224216
1138589	X224216
1138590	X224478
1138591	X224272
1138594	X224215
1138597	X224271
1138599	X224423
1138600	X224215
1138601	X224477
1138606	X225116
1138607	X225115
1138611	X254108
1138612	X254107
1138617	X254140
1138618	X254139
1138619	X254138
1138620	X254137
1138621	X375012
1138621	X375080
1138622	X375011
1138625	X375012
1138626	X375011
1138651	X224560
1138653	X224559
1144076	X275016
1144077	X275020
1144078	X275019
1144079	X275015
1223615	X224602
1223616	X224601
1223704	X225282
1223706	X225281
1324304	X225282
1324305	X225281
1328617	X255040
1328618	X255039
1328619	X255068
1328620	X255067
1355099	X224676
1355100	X224675
1355131	X375338
1355133	X375337
1356387	X275031
1356388	X275032
1356393	X275033
1356394	X275034
1365648	X225282
1365653	X225281
1368542	X224684
1368543	X224683
1371370	X274090
1371372	X274089
1371407	X275054
1371412	X275053

FORD	
------	--

Références d'origine Etrier

O.E.M. - OE Nummern - Codigos originales - Codici originali

FORD		FORD		FORD		FORD		FORD		FORD	
1502341	X375361	1755032	X224601	6059364	X374123	6193082	X464102	4S712553BA	X275033	86VB002B120AA	X254053
1504905	X275034	1760070	X225446	6061185	X254068	6193083	X464101	4S712553BB	X275033	86VB002B120BA	X464067
1504906	X275032	1760071	X225445	6061186	X254067	6197106	X224004	5S6Y2B294AA	X224676	86VB002B120CA	X464021
1504907	X275031	1761267	X225446	6121621	X224004	6197740	X254140	5S6Y2B302AA	X224675	86VB002B120DA	X254211
1511966	X224354	1761268	X225445	6122831	X224175	6197741	X254138	692038B	X375012	86VB002B121AA	X254054
1511968	X224353	1761755	X225446	6122832	X224176	6197741	X254140	692068B	X375012	86VB002B121BA	X464068
1521149	X274090	1761756	X225445	6130489	X224004	6197742	X254139	6C112552AB	X275054	86VB002B121CA	X464022
1521150	X274089	1783930	X274128	6130493	X224003	6197743	X254137	6C112552AC	X275054	86VB002B121DA	X254212
1521632	X275054	1783931	X274126	6132057	X374120	6197743	X254139	6C112552AD	X275054	86VB2B120AA	X254212
1521636	X275053	1783932	X274127	6132059	X374119	6422727	X224175	6C112553AB	X275053	86VB2B120CA	X464021
1522074	X275016	1783933	X274125	6134735	X224016	6422727	X224176	6C112553AC	X275053	86VB2B120DA	X254212
1522076	X275015	1802059	X224602	6134736	X224015	6422728	X224268	6C112553AD	X275053	86VB2B121AA	X254211
1536999	X375361	1802060	X224601	6143445	X224004	6422729	X224175	6C112B120AC	X274090	86VB2B121CA	X464022
1537001	X375362	1816197	X274128	6143447	X224003	6422730	X224267	6C112B120AD	X274090	86VB2B121DA	X254211
1550200	X374714	1817682	X274127	6143447	X224004	6449784	X224268	6C112B120BA	X274086	88BB2L231CA	X224004
1550207	X374713	1954457	X374394	6143449	X224016	6449785	X224267	6C112B120BB	X274086	88BB2L231EA	X224176
1551477	X374706	1956423	X374393	6143451	X224175	6483474	X225116	6C112B121AC	X274089	88BB2L232CA	X224003
1551479	X374705	1956494	X374393	6143455	X224003	6483475	X225115	6C112B121AD	X274089	88BB2L232EA	X224175
1551989	X285103	1959343	X374394	6143455	X224004	6500957	X224422	6C112B121BA	X274085	88VB2B120AA	X254212
1551990	X285104	1959344	X374393	6143457	X224015	6500958	X224421	6C112B121BB	X274085	88VB2B120BA	X254054
1553793	X274086	1960229	X374393	6143459	X224176	6513463	X375080	6G912B294AA	X224664	88VB2B121AA	X254211
1553794	X274085	3187377	X254053	6145457	X224002	6513464	X375012	6G912B294AB	X224664	88VB2B121BA	X254053
1554749	X274084	3664573	X525010	6145459	X224001	6513465	X375079	6G912B294AC	X224664	89GB2L591AA	X375079
1554750	X274114	3664608	X594004	6148319	X375012	6513466	X375011	6G912B302AA	X224663	89VB2B120AA	X254212
1554756	X274113	3664617	X594004	6148320	X375012	6668590	X224272	6G912B302AB	X224663	89VB2B121AA	X254211
1554757	X274083	3664619	X594003	6148321	X375011	6668591	X224424	6G912B302AC	X224663	8C1V2K327BA	X285104
1566114	X374706	3664620	X594003	6150952	X254056	6668592	X224271	6G912D048FC	X377042	8C1V2K327BB	X285104
1566115	X374705	3998559	X525009	6150952	X254212	6668593	X224423	6G912D048GA	X375362	8C1V2K328BA	X285103
1583139	X224664	4055819	X274048	6150955	X254054	6669768	X255039	6G912D048GB	X375362	8C1V2K328BB	X285103
1583140	X224663	4055820	X274047	6150955	X254211	6669769	X255040	6G912D048GC	X375362	8M512M088BB	X225446
1583351	X374706	4084640	X224794	6150956	X254055	6687170	X224424	6G912D048GD	X375362	8M512M088BC	X225446
1583352	X374705	4084641	X224793	6150956	X254211	6687171	X224423	6G912D048GE	X375362	8M512M088CA	X225446
1587089	X464022	4346372	X224792	6150959	X254053	6700130	X255067	6G912D048GF	X375362	8M512M088CB	X225446
1587090	X464021	4346373	X224791	6150959	X254210	6700130	X255068	6G912D048KB	X375362	8M512M089BB	X225445
1587091	X464018	4427735	X224606	6152221	X375012	6700131	X255067	6G912D049FC	X377041	8M512M089BC	X225445
1587092	X464019	4427736	X224605	6152222	X375012	6700131	X255068	6G912D049GA	X375361	8M512M089CA	X225445
1595762	X254068	4500868	X225302	6152223	X375011	7114002	X225116	6G912D049GB	X375361	8M512M089CB	X225445
1595763	X254067	4500870	X225301	6152224	X375011	7114003	X225115	6G912D049GC	X375361	8V512B294AA	X374714
1604577	X224172	4520606	X374617	6154068	X224175	7201628	X224450	6G912D049GD	X375361	8V512B302AA	X374713
1604578	X224171	4526607	X224794	6154068	X224176	7201630	X224449	6G912D049GE	X375361	91AB2B294AA	X254104
1625702	X224175	4533461	X225371	6154070	X224175	61180198	X375012	6G912D049GF	X375361	91AB2B294BA	X254108
1625703	X224175	4533462	X225372	6154070	X224176	0K20549980	X225116	6G912D049KB	X375361	91AB2B302AA	X254103
1625703	X224176	4572816	X225372	6159330	X224172	0K20549990	X225115	6G912D48GE	X375362	91AB2B302BA	X254107
1630040	X224003	4572817	X225371	6159331	X224171	1S712253AE	X275015	6G912D49GE	X375361	91AB2L590BC	X225116
1630040	X224004	4682839	X225372	6167654	X375080	1S712552AE	X275016	76AB2L231AA	X254143	91AB2L591BC	X225115
1630135	X224003	4682841	X225371	6167655	X375079	1S712552AE	X275020	76AB2L232AA	X254144	91AX2L590BC	X225116
1637876	X224106	5021742	X224003	6176621	X224216	1S712552BE	X275020	76VB002B120DB	X464019	91AX2L591BC	X225115
1637877	X224105	5021743	X224004	6176623	X224215	1S712553AE	X275019	76VB002B120EC	X464011	91GB2L231AA	X224268
1653141	X254055	5021746	X224175	6180198	X375080	1S712553BE	X275019	76VB002B120FC	X464011	91GB2L232AA	X224267
1653141	X254211	5021747	X224176	6180199	X375079	1S712B294AA	X274046	76VB002B120GC	X464013	92GB2552BA	X375012
1653142	X254054	5021817	X375012	6180377	X254104	1S712B294AB	X274046	76VB002B120G	X464015	92GB2553BA	X375011
1660025	X254056	5021818	X375011	6180378	X254108	1S712B294AC	X274046	76VB002B121DB	X464018	92VB2B120AA	X254138
1660025	X254212	5023217	X254068	6180379	X254103	1S712B302AA	X274045	76VB002B121EC	X464012	92VB2B120BA	X254140
1661469	X224268	5023218	X254067	6180380	X254107	1S712B302AB	X274045	76VB002B121FC	X464014	92VB2B121AA	X254137
1661470	X224267	5023219	X374120	6187159	X224004	1S712B302AC	X274045	76VB002B121G	X464012	92VB2B121BA	X254139
1682875	X224602	5023220	X374119	6187230	X224015	3M512B294AA	X224602	76VB02B120DB	X464019	92VB2B121CA	X254137
1682876	X224601	5023221	X224016	6187313	X224004	3M512B294BA	X224602	76VB02B121DB	X464020	92VB2K120AA	X254138
1690468	X377042	5023222	X224015	6187315	X224016	3M512B302AA	X224601	77FB2L231DD	X254068	92VB2K120BA	X254140
1690469	X377041	5023225	X375012	6187316	X224172	3M512M088AA	X225282	77FB2L231DE	X254068	92VB2K121AA	X254137
1701876	X374706	5023226	X375011	6187318	X224003	3M512M088AB	X225282	77FB2L231DF	X254068	92VB2K121AA	X254139
1701877	X374705	5023228	X224001	6187320	X224015	3M512M088BA	X225282	77FB2L232DD	X254067	92VB2K121BA	X254139
1701880	X375362	5023229	X224003	6187321	X224171	3M512M089AA	X225281	77FB2L232DE	X254067	93BB2552AA	X255039
1701884	X375361	5023230	X224004	6187322	X224171	3M512M089AB	X225281	77FB2L232DF	X254067	93BB2553AA	X255040
1730926	X225446	5023231	X224176	6187376	X254212	3M512M089BA	X225281	7D0615423B	X375153	93BB2L231AA	X224272
1730929	X225445	5023232	X224175	6187377	X254053	4N112552AA	X375338	82AB2L231DC	X224004	93BB2L232AA	X224271
1731137	X274114	6024624	X374066	6188428	X224478	4N112553AA	X375337	82AB2L232DC	X224003	95VV2B118BA	X224450
1731147	X274114	6024625	X374065	6188429	X224477	4S712552AA	X275032	85GB2L590AD	X375012	95VV2B118BB	X224450
1738987	X375362	6045898	X254068	6189159	X224004	4S712552AB	X275032	85GB2L590BD	X375012	95VV2B119BA	X224449
1738988	X375361	6045899	X254067	6189161	X224175	4S712552BA	X275034	85GB2L591AD	X375011	95VV2B119BB	X224449
1738990	X375362	6050320	X254144	6189162	X224003	4S712552BB	X275034	85GB2L591BD	X375011	96FB2L231AA	X224216
1742267	X375361	6050321	X254143	6189164	X224176	4S712553AA	X275031	85GX2N118AD	X375012	96FB2L232AA	X224215
1755031	X224602	6059363	X374124	6192082	X254211	4S712553AB	X275031	85GX2N119AD	X375011	96FX2B294AA	X224216

Références d'origine Etrier

O.E.M. - OE Nummern - Codigos originales - Codici originali

FORD	
96FX2B294BA	X224478
96FX2B302AA	X224215
96FX2B302BA	X224477
97AG2B294BA	X254108
97AG2B302BA	X254107
97BC2L231CA	X224272
97BC2L232CA	X224271
97BX2B294CA	X224272
97BX2B302BA	X224271
98AB2552AA	X375156
98AB2553AA	X375155
98AB2L231BB	X224496
98AB2L232BB	X224495
98AX2552AA	X375156
98AX2553AA	X375155
9M512B294AA	X374706
9M512B294BA	X374706
9M512B302AA	X374705
9M512B302AC	X374705
9M512B302BA	X374705
9S512B120EA	X274084
9S512B120FA	X274114
9S512B120GA	X274113
9S512B120HA	X274083
AV612B294AA	X224602
AV612B302AA	X224601
BK212B294AA	X274128
BK212B294BA	X274126
BK212B302AA	X274127
BK212B302BA	X274125
BK312B294AA	X274128
BK312B302AA	X274127
BPYK2671XB	X225281
BPYK3361XA	X224602
BPYK3361XB	X224602
BPYK3361XC	X224602
BPYK3371XB	X224601
BPYK3371XC	X224601
BS512B120BA	X274114
CN152B294BA	X224602
CN152B302BA	X224601
CV612B294PA	X224602
CV612B302PA	X224601
GJ2533990B	X164089
LRG500	X374239
LRG501	X374240
LRG600	X375157
LRG601	X375158
LRG602	X375159
LRG603	X375160
R88AX2N118BB	X224004
R89GX2553AB	X375079
R92VX2B120AB	X254140
R92VX2B120BB	X254138
R92VX2B121AB	X254139
R92VX2B121BB	X254137
R93BX2552AE	X255039
R93BX2553AE	X255039
R96FX2B294AB	X224216
R96FX2B294BB	X224478
R96FX2B302AB	X224215
R96FX2B302BB	X224477
RMV6J2B302AA	X224571
RMV6J2B294A	X224572
RMV6J2B294C	X224574
RMV6J2B302C	X224573
S12133980	X644046
S12133990	X644045
YC152B120AA	X274048
YC152B121AA	X274047
YS612L231AA	X224572
YS612L231CA	X224574

FORD	
YS612L232AA	X224571
YS612L232CA	X224573
YS6J2B294AA	X224572
YS6J2B294CA	X224574
YS6J2B302AA	X224571
YS6J2B302CA	X224573
GENERAL MOTORS	
5542451	X375367
5542452	X375368
9121358	X274065
9121359	X274066
9196052	X374504
13275846	X375429
13275847	X375430
13279638	X484057
13279639	X484058
13279640	X484059
13279641	X484060
13343567	X375429
13343568	X375430
15254646	X225453
15254647	X225454
22705313	X164330
22705314	X164329
90297533	X225080
93170598	X375241
93176375	X224707
93176376	X224708
93179154	X375301
93181406	X225401
93181407	X225402
93185748	X224693
93185749	X224694
93190648	X224522
93191690	X274077
93191691	X274078
93191695	X274071
93191695	X274072
93192955	X374672
93192956	X374671
96625936	X484051
96625937	X484052
96626050	X485019
96626051	X485020
96626073	X485019
96626074	X485020
HONDA	
45210634652	X674052
45210634920	X674052
45210657672	X674022
45210659003	X674022
45210659013	X674022
45210671672	X164036
45210671672	X164050
45210671674	X164036
45210671674	X164050
45210692671	X644032
45210692672	X644032
45210693602	X644032
45230634652	X674051
45230634920	X674051
45230657672	X674021
45230659003	X674021
45230659013	X674021
45230671672	X164049
45230671672	X674051
45230671674	X164049
45230671674	X674051
45230692671	X644032
45230693602	X644031
4019SF1003	X584003
43001TV0E01	X225409

HONDA	
43001TV0E02	X225409
43001TV0E03	X225409
43002TV0E01	X225410
43002TV0E02	X225410
43002TV0E03	X225410
43012S1AE01	X375216
43012SEAE01	X375216
43012SMGE01	X375442
43012SMGE02	X375442
43012SN7G00	X375096
43012SN7G00	X585022
43012ST3E00	X375082
43012ST3E01	X375082
43012ST3E50	X375410
43013S1AE01	X375215
43013SEAE01	X375215
43013SN7G00	X375095
43013SN7G00	X585021
43013ST3E00	X375081
43013ST3E01	X375081
43013ST3E50	X375409
43018S03Z02	X585034
43018S04003	X585020
43018S2A003	X585038
43018S2A013	X585038
43018S30N21	X585028
43018S30N22	X585028
43018SSAJ02	X585036
43018S6MA01	X585036
43018S7A000	X585040
43018S7S000	X585016
43018S84A11	X165144
43018S84A53	X585032
43018S9AA00	X585016
43018S9AE00	X585016
43018SAAJ50	X585046
43018SAAJ51	X585046
43018SE0900	X585002
43018SJA010	X585054
43018SK7000	X585004
43018SL0003	X585030
43018SL0013	X585030
43018SMGE01	X375442
43018SMGE02	X375442
43018SO4003	X585020
43018SR3000	X585020
43018SS0000	X585028
43018SV4A00	X585022
43018SV4A01	X585022
43018SWAA10	X585016
43018SWWG00	X275064
43018SX0000	X585016
43018SXS000	X585048
43018SZ3A01	X585040
43018TA0A01	X585050
43018TA0A02	X585050
43018TA0A51	X585052
43018TA0A81	X585052
43019S03Z02	X585033
43019S04003	X585019
43019S2A003	X585037
43019S2A013	X585037
43019S30N21	X585027
43019S30N22	X585027
43019S5AJ02	X585035
43019S6MA01	X585035
43019S7A000	X585039
43019S7S000	X585015
43019S84A11	X165143
43019S84A53	X585031
43019S9AA00	X585015
43019S9AE00	X585015

HONDA	
43019SAAJ50	X585045
43019SAAJ51	X585045
43019SE0900	X585001
43019SJA010	X585053
43019SK7000	X585003
43019SL0003	X585029
43019SL0013	X585029
43019SMGE01	X375441
43019SMGE02	X375441
43019S04003	X585019
43019SR300	X585019
43019SR3000	X585019
43019SS0000	X585027
43019SV4A00	X585021
43019SV4A01	X585021
43019SWAA10	X585015
43019SWWG00	X275063
43019SX0000	X585015
43019SX0000	X585047
43019SZA01	X585039
43019TA0A01	X585049
43019TA0A02	X585049
43019TA0A51	X585051
43019TA0A81	X585051
43021SK3E00	X375082
43021ST3E00	X375082
43023SK3E00	X375081
43103SMGE01	X375441
43103SMGE02	X375441
43210SA5955	X675002
43210SA5982	X675025
43210SA5982	X675026
43210SB0951	X675002
43210SB0952	X675002
43210SB0982	X675002
43210SB0983	X675002
43210SD2931	X585002
43210SD2932	X585002
43210SD2933	X585002
43210SD2934	X585002
43210SD2935	X585002
43210SD2936	X585002
43210SD2937	X585002
43210SD4015	X675020
43210SE0933	X585002
43210SE0934	X585002
43210SE0935	X585002
43210SF0003	X585010
43210SF0013	X585010
43210SF0023	X585010
43210SF0033	X585010
43210SF0N50	X585010
43210SF1003	X585012
43210SF1013	X585012
43210SF1023	X585012
43210SF1023S	X585012
43210SF1033	X585012
43210SF1043	X585012
43210SF1063	X585012
43210SF1063	X585012
43210SF1J00	X585012
43210SF1J01	X585012
43210SF1S05	X585012
43210SG0G01	X585018
43210SG0G02	X585018
43210SG0G03	X585018
43210SH3G01	X585004
43210SH3G02	X585004
43210SH3G03	X585004
43210SH3G04	X585004
43210SH3J01	X585004
43210SH3N31	X585004
43210SK7033	X585004

HONDA	
43210SL0013	X585030
43210SL5A01	X585018
43210SM4G02	X585022
43210SM4G03	X585022
43210SM4G04	X585022
43210SM4G64	X585024
43210SP0003	X585016
43210SP0E01	X585016
43210SP0E03	X585016
43210SR3G01	X585020
43210SR3G02	X585020
43210SR3G03	X585020
43210SS0003	X585028
43210SV4A02	X585022
43230SA5955	X675001
43230SA5982	X675025
43230SA5982	X675026
43230SB0951	X675001
43230SB0951	X675002
43230SB0952	X675001
43230SB0982	X675001
43230SB0983	X675001
43230SD2931	X585001
43230SD2932	X585001
43230SD2933	X585001
43230SD2934	X585001
43230SD2935	X585001
43230SD2936	X585001
43230SD2937	X585001
43230SD4015	X675019
43230SE0933	X585001
43230SE0934	X585001
43230SE0935	X585001
43230SF0003	X585009
43230SF0013	X585009
43230SF0023	X585009
43230SF0033	X585009
43230SF0N50	X585009
43230SF1003	X585011
43230SF1013	X585011
43230SF1023	X585011
43230SF1023S	X585011
43230SF1033	X585011
43230SF1043	X585011
43230SF1063	X585011
43230SF1J00	X585011
43230SF1J01	X585011
43230SF1S05	X585011
43230SG0G01	X585017
43230SG0G02	X585017
43230SG0G03	X585017
43230SH3G01	X585003
43230SH3G02	X585003
43230SH3G03	X585003
43230SH3G04	X585003
43230SH3J01	X585003
43230SH3N31	X585003
43230SK7033	X585003
43230SL0013	X585029
43230SL5A01	X585017
43230SM4G02	X585021
43230SM4G03	X585021
43230SM4G04	X585021
43230SM4G64	X585023
43230SP0003	X585015
43230SP0E01	X585015
43230SP0E03	X585015
43230SR3000	X585019
43230SR3G01	X585019
43230SR3G02	X585019
43230SR3G03	X585019
43230SS0003	X585027

HONDA	
43230SV4A02	X585021
45001SEAE01	X224701
45001TL1G01	X224797
45001TV0E01	X224837
45002SEAE01	X224702
45002TL1G01	X224798
45002TV0E01	X224838
45012S1AE01	X374624
45012S1AE61	X374622
45012S6DE01	X374167
45012S6DE02	X374167
45012S6FE01	X374762
45012SMGE01	X374756
45012SN7G41	X374374
45012SN7G50	X374372
45012SN7G50	X374374
45012ST3E00	X374168
45013S1AE01	X374623
45013S1AE61	X374621
45013S6DE01	X374168
45013S6DE02	X374168
45013S6FE01	X374761
45013SMGE01	X374755
45013SN7G41	X374373
45013SN7G50	X374371
45013SN7G50	X374373
45013ST3E00	X374167
45018S04000	X584024
45018S04003	X584026
45018S04013	X584024
45018S04G01	X584024
45018S04V01	X584026
45018S1AE21	X584046
45018S2A003	X584040
45018S5AJ01	X584062
45018S5AJ02	X584062
45018S5TE00	X584040
45018S6MA01	X584040
45018S7AN02	X584044
45018S87G02	X584046
45018S9AA01	X164302
45018S9AA02	X164302
45018S9AE00	X164302
45018SAA900	X5

Références d'origine Etrier

O.E.M. - OE Nummern - Codigos originales - Codici originali

HONDA	
45018SR3V00	X584026
45018SR3V01	X584026
45018SS0000	X584034
45018SS0A00	X374372
45018SW5003	X584010
45018SWWG00	X274116
45018SZ3A01	X584052
45018T1EG00	X274116
45018TLOG50	X164312
45019S04000	X584023
45019S04003	X584025
45019S04013	X584023
45019S04G01	X584023
45019S04V01	X584025
45019S1AE21	X584045
45019S2A003	X584039
45019S5AJ01	X584061
45019S5AJ02	X584061
45019S5TE00	X584039
45019S6MA01	X584039
45019S7AN02	X584043
45019S87G02	X584045
45019S9AA01	X164301
45019S9AA02	X164301
45019S9AE00	X164301
45019SAA900	X584041
45019SAAE50	X584041
45019SB0675	X164049
45019SF1003	X584003
45019SH3E11	X584021
45019SH3E11	X584035
45019SH3G03	X584013
45019SH3G33	X584003
45019SH3G51	X584011
45019SH3G51	X584013
45019SH3N32	X584005
45019SJAE02	X114015
45019SJAEO3	X114015
45019SJFJ00	X584043
45019SJFJ01	X584043
45019SJHE00	X584043
45019SK7003	X584005
45019SL0003	X584031
45019SM5000	X374371
45019SMGE01	X374755
45019SMT E00	X584059
45019SNB000	X584057
45019SNC000	X584053
45019SO4000	X584023
45019SO4003	X584023
45019SO4003	X584025
45019SO4G01	X584023
45019SO4V01	X584025
45019SPOE01	X584027
45019SR3G00	X584023
45019SR3V00	X584025
45019SR3V01	X584025
45019SS0000	X584033
45019SS0A00	X374371
45019SW5003	X584009
45019SWWG00	X274115
45019SZ3A01	X584051
45019T1EG00	X274115
45019TLOG50	X164311
45021SK3E00	X374168
45023SK3E00	X374167
4509SH3G33	X584003
45210SA0671	X674038
45210SA0672	X674038
45210SA0682	X674019
45210SA0682	X674020
45210SA0691	X674038

HONDA	
45210SA0692	X674038
45210SA0771	X674038
45210SA0772	X674038
45210SA3672	X164050
45210SA3672	X675001
45210SA5602	X674002
45210SA6602	X484004
45210SB0671	X164050
45210SB0672	X164050
45210SB0673	X164050
45210SB0674	X164050
45210SB0675	X164050
45210SB6602	X644042
45210SD2A00	X164046
45210SD2A01	X164046
45210SD2A03	X164046
45210SD2A13	X164046
45210SD2G01	X164046
45210SD4023	X584006
45210SD4033	X584006
45210SD4670	X584006
45210SD4671	X584006
45210SD4672	X584006
45210SD4673	X584006
45210SD4674	X584006
45210SD4675	X584006
45210SD4E01	X584006
45210SD4E02	X584006
45210SD4E03	X584006
45210SEOA03	X164046
45210SEOA13	X164046
45210SE0G11	X584006
45210SE0G12	X584006
45210SF1013	X584004
45210SF1023	X584004
45210SF1033	X584004
45210SG0G11	X584006
45210SG0G12	X584006
45210SG0G13	X584006
45210SH3931	X584004
45210SH3932	X584004
45210SH3E11	X584022
45210SH3E11	X584036
45210SH3G11	X584036
45210SH3G22	X164082
45210SH3G23	X164082
45210SH3G32	X584004
45210SH3G33	X584004
45210SH3G51	X584012
45210SH3G51	X584014
45210SH3N32	X584006
45210SM2023	X584030
45210SM4A02	X164206
45210SM4G04	X374372
45210SM4G05	X374372
45210SM5A01	X374372
45210SM5A01	X374372
45210SM5G51	X374371
45210SM5G51	X374372
45210SM5G51	X374372
45210SO0E01	X584028
45210SO0E01	X584028
45210SO4911	X584022
45210SPOE01	X584028
45210SR3912	X584022
45210SR3912	X584036
45210SR3G01	X584024
45210SR3G01	X584024
45210SR3G02	X584024
45210SR3V12	X584025
45210SR3V12	X584025
45210SR3V14	X584026
45210SS0G01	X374372
45210SS0G11	X584030
45210SS0G12	X584030
45230SA0671	X674037
45230SA0672	X674037
45230SA0682	X674019
45230SA0691	X674038

HONDA	
45230SA0691	X674037
45230SA0692	X674037
45230SA0771	X674037
45230SA0772	X674037
45230SA3672	X164049
45230SA5602	X674001
45230SA6602	X484003
45230SB0671	X164049
45230SB0672	X164049
45230SB0673	X164049
45230SB0674	X164049
45230SB0675	X164049
45230SB6602	X644041
45230SC0672	X164049
45230SD2A00	X164045
45230SD2A01	X164045
45230SD2A03	X164045
45230SD2A13	X164045
45230SD2G01	X164045
45230SD4023	X584005
45230SD4033	X584005
45230SD4670	X584005
45230SD4671	X584005
45230SD4672	X584005
45230SD4673	X584005
45230SD4674	X584005
45230SD4675	X584005
45230SD4E01	X584005
45230SD4E02	X584005
45230SD4E03	X584005
45230SE0G11	X584005
45230SE0G12	X584005
45230SF1_023	X584003
45230SF1013	X584003
45230SF1023	X584003
45230SF1033	X584003
45230SG0G11	X584005
45230SG0G12	X584005
45230SG0G13	X584005
45230SH3931	X584003
45230SH3932	X584003
45230SH3E11	X584021
45230SH3E11	X584035
45230SH3G11	X584035
45230SH3G22	X164081
45230SH3G23	X164081
45230SH3G32	X584003
45230SH3G33	X584003
45230SH3G51	X584013
45230SH3N32	X584005
45230SM2023	X584029
45230SM4A02	X164205
45230SM4G04	X374371
45230SM4G05	X374371
45230SM5A01	X374371
45230SM5G51	X374371
45230SO0E01	X584027
45230SO4911	X584021
45230SP0E01	X584027
45230SR3912	X584021
45230SR3912	X584035
45230SR3G01	X584023
45230SR3G02	X584023
45230SR3V12	X584025
45230SR3V14	X584025
45230SS0G01	X374371
45230SS0G11	X584029
45230SS0G12	X584029
BNP7156	X674038
GBC90175	X374372
HYUNDAI	
581102E000	X484049

HYUNDAI	
581302E000	X484050
582102E000	X485023
582302E000	X485024
4811008260	X484033
4814008260	X484034
5811005500	X484045
5811017400	X484055
5813005500	X484046
5813017400	X484056
5821017300	X485007
5823017300	X485008
5830026050	X485011
5840026050	X485012
582102E300	X485023
582302E300	X485024
1K58250810QQ	X475001
1K58260810QQ	X475002
383113AA00	X485012
581100B300	X484001
581100X300	X484061
581101C100	X484001
581101F000	X484049
581101G100	X774005
581101H000	X774023
581101H100	X774023
581101J100	X484063
581101J600	X484061
581101K000	X774045
581102B700	X484053
581102D500	X484025
581102D550	X484025
581102D700	X484055
581102E500	X484049
581102H300	X484043
581102H500	X484043
581102L500	X774039
581102M000	X484071
581102S700	X774029
581102V500	X774041
581102Y000	X774029
581103A200	X484033
581103J500	X774033
581103K150	X484075
581103K170	X484075
581103L050	X484075
581103M000	X484073
581103M010	X484073
581103S250	X774043
581103Z100	X774035
581103Z700	X774037
581104H500	X774051
58110A6000	X774053
58110A6200	X774055
58110B9700	X484081
58110H1000	X484065
58110H1080	X484067
58111H1000	X484066
581300B300	X484002
581300X300	X484062
581301C100	X484002
581301F000	X484050
581301G100	X774006
581301H000	X774024
581301J100	X484064
581301J600	X484062
581301K000	X774046
581302B700	X484054
581302D500	X484026
581302D550	X484026
581302D700	X484056
581302E500	X484050
581302H300	X484044

HYUNDAI	
581302H500	X484044
581302L500	X774040
581302M000	X484072
581302Q000	X484044
581302S700	X774030
581302V500	X774042
581302Y000	X774030
581303A200	X484034
581303J500	X774034
581303K150	X484076
581303K170	X484076
581303L050	X484076
581303M000	X484074
581303M010	X484074
581303S250	X774044
581303Z100	X774036
581303Z700	X774038
581304H500	X774052
58130A6000	X774054
58130A6200	X774056
58130B9700	X484082
58130H1000	X484066
58130H1080	X484068
5818002A00	X484015
5818002A10	X484045
581800XA00	X484061
581801GA00	X774005
581801HA00	X774023
581801JA10	X484063
581801JA60	X484061
581801KA00	X774045
581802A000	X484003
5818023A00	X484001
5818024A00	X484001
5818025A00	X484001
5818026A00	X484033
5818026A10	X484033
5818028A00	X484001
5818028B00	X484005
5818029A10	X484007
5818029A20	X484007
5818029A30	X484007
5818029A40	X484025
581802B700	X484053
581802BA00	X484053
581802BA10	X484053
581802CA10	X484031
581802DA10	X484055
581802DA20	X484055
581802EA00	X484049
581802EA10	X484049
581802HA00	X484043
581802LA00	X774039
581802LA10	X774039
581802MA00	X484071
581802SA70	X774029
581802VA50	X774041
5818033A00	X484009
5818034A00	X484009
5818034A10	X484009
5818034A10	X484029
5818034A20	X484011
5818035A00	X484009
5818035A00	X484029
5818038A00	X484039
5818038A11	X484031
5818039A00	X484033
581803AA00	X484033
581803AA10	X484033
581803JA50	X774033
581803KA00	X484075

HYUNDAI	
581803KA01	X484043
581803KA10	X484075
581803LA00	X484075
581803MA00	X484073
581803MA01	X484073
581803SA25	X774043
581803ZA00	X774035
581803ZA70	X774037
5818044A00	X484013
581804AA00	X484023
581804AA90	X484034
581804AA90	X484079
581804AA91	X484079
581804HA00	X774051
58180A6A00	X774053
58180A6A20	X774055
58180B9A70	X484081
58180H1A00	X484065
5	

Références d'origine Etrier

O.E.M. - OE Nummern - Codigos originales - Codici originali

HYUNDAI	
581903KA01	X484044
581903KA10	X484076
581903LA00	X484076
581903MA00	X484074
581903MA01	X484074
581903SA25	X774044
581903ZA00	X774036
581903ZA70	X774038
581904AA00	X484014
581904AA00	X484024
581904AA90	X484033
581904AA90	X484080
581904AA91	X484080
581904HA00	X774052
58190A6A00	X774054
58190A6A20	X774056
58190AA00	X484024
58190B9A70	X484082
58190H1A00	X484066
58190H1A30	X484068
58190H1A40	X484068
5821017A00	X485007
5821017A10	X485007
582101H300	X775011
582102B700	X485021
582102F200	X485005
582102H300	X485043
582102H500	X485043
582102M000	X485035
582102P700	X485045
582102S700	X775017
582102Y300	X775015
582102Y500	X775017
582103A200	X485012
582103J500	X775019
582103K150	X485013
582103K350	X485013
582103K500	X485013
582103M100	X485037
582103M110	X485037
582103S200	X775017
582103Z100	X485033
582103Z100	X487001
582103Z700	X485033
582103Z700	X487001
582104H500	X775033
58210A6200	X777001
5821117A00	X485008
5821117A10	X485008
582301D100	X775014
582301H300	X775012
582302B700	X485022
582302H300	X485044
582302H500	X485044
582302M000	X485036
582302P700	X485046
582302S700	X775018
582302Y300	X775016
582302Y500	X775018
582303A200	X485011
582303J500	X775020
582303K150	X485014
582303K350	X485014
582303K500	X485024
582303M100	X485038
582303M110	X485038
582303S200	X775018
582303Z100	X485034
582303Z100	X487002
582303Z700	X485034
582303Z700	X487002
582304H500	X775034

HYUNDAI	
58230A6200	X777002
583001C800	X485025
583001J300	X485027
583001J310	X485027
583001K300	X475001
583001K300	X775023
583002V500	X775021
58300A6300	X775031
583100X300	X485031
583100XA00	X485031
583101HA00	X775011
583101JA30	X485027
583101KA30	X475001
583101KA30	X775023
583102BA00	X485003
583102EA00	X485005
583102EA10	X485023
583102HA00	X485043
583102MA00	X485035
583102PA70	X485045
583102SA70	X775017
583102VA50	X775021
583102YA30	X775015
583103A400	X485001
583103A410	X485001
583103A500	X485001
583103SA01	X485001
583103SA00	X485001
583103BA10	X485007
583103A00	X485011
583103AA00	X485012
583103JA50	X775019
583103KA00	X485013
583103KA02	X485013
583103KA04	X485013
583103KA10	X485013
583103KA35	X485013
583103KAA0	X485013
583103SA20	X775017
583103ZA00	X485033
583103ZA00	X487001
583103ZA70	X485033
583103ZA70	X487001
583104HA00	X775033
58310A6A20	X777001
58310A6A30	X775031
58310H1010	X485009
58310H1A00	X485009
58310H1A10	X485009
583110XA00	X485032
583111HA00	X775012
583111JA30	X485028
583111KA30	X475002
583111KA30	X775024
583112BA00	X485022
583112DA00	X485006
583112EA00	X485024
583112EA10	X485024
583112HA00	X485044
583112MA00	X485036
583112PA70	X485046
583112SA70	X775018
583112VA50	X775022
583112YA30	X775016
583113BA10	X485008
583113AA00	X485011
583113JA50	X775020
583113KA00	X485014
583113KA02	X485014
583113KA04	X485014

HYUNDAI	
583113KA10	X485014
583113KA35	X485014
583113KAA0	X485014
583113SA20	X775018
583113ZA00	X487002
583113ZA70	X485034
583113ZA70	X487002
58311A6A20	X777002
58311A6A30	X775032
58311H1010	X485010
58311H1A00	X485010
58311H1A10	X485010
5832028A00	X485004
5832029A20	X485006
5832034A00	X485002
5832034A10	X485002
5832035A00	X485002
5832035A01	X485002
583204HA00	X775034
583600X300	X485032
58360H1010	X485010
584001C800	X485026
584001J300	X485028
584001J310	X485028
584001K300	X475002
584001K300	X775024
584002V500	X775022
58400A6300	X775032
HB401003	X484017
HB401004	X484018
MB058504	X644036

ISUZU	
542049	X164117
542050	X164118
542053	X164118
542277	X164117
542278	X164118
94122352	X644098
94122353	X644097
94388014	X164198
94388015	X164197
94438685	X164118
94438685	X164198
94438686	X164117
94438686	X164197
894122352	X644098
894122353	X644097
894124768	X645004
894124769	X645003
8941154051	X164176
8941154061	X164175
8941247770	X164086
8941247771	X164084
8941247780	X164085
8941247781	X164083
8942305291	X164084
8942305292	X164084
8942305301	X164083
8942305302	X164083
8942314452	X165042
8942314462	X165041
8942337280	X164116
8942337290	X164115
8943160970	X164198
8943160980	X164197
8943720490	X525004
8943720500	X525003
8943880120	X164198
8943880130	X164197
8943880160	X164118
8943880170	X164117
8944386850	X164118

ISUZU	
8944386851	X164118
8944386860	X164117
8944386861	X164117
8944533880	X525004
8944533890	X525003
8970312410	X525006
8970312420	X525005
8970653500	X164118
8970653510	X164117
8970666020	X525006
8970666030	X525005

IVECO	
4830046	X374389
4830047	X374390
4830627	X374388
4832627	X375135
4832628	X375136
4855362	X284001
4855363	X284002
4855364	X284001
4855708	X614005
4855708	X614006
4855709	X614005
4855709	X614006
4859108	X464023
42530362	X285039
42530363	X285040
42534119	X284039
42534120	X284040
42535438	X285045
42535439	X285046
42535599	X284091
42535600	X284092
42536626	X285037
42536628	X284037
42536629	X284038
42536630	X285021
42536631	X285022
42536632	X284091
42536633	X284092
42536634	X285045
42536635	X285046
42548179	X284137
42548180	X284138
42548183	X284091
42548184	X284092
42548185	X285045
42548186	X285046
42554759	X285052
42554777	X285021
42554778	X285022
42554785	X285051
42554990	X285049
42554991	X285050
42555557	X284105
42555558	X284106
42555559	X284103
42555560	X284104
42560072	X284105
42560073	X284106
93192369	X284033
93192370	X284034
93802698	X464004
93802699	X464003
93808050	X464024
98410367	X284003
98410369	X284004
99465302	X614004
99465304	X614003
500302157	X284001
500302258	X284001
504120470	X284105

IVECO	
504120471	X284106
504120969	X285051
504120970	X285052
504121785	X284103
504121786	X284104
504122833	X285049
504122834	X285050
504134582	X285021
504134583	X285022
504139833	X284105
504139834	X284106
LRG614	X375137
LRG615	X375138

JAGUAR	
12796	X374509
12797	X374510
AAU2102	X374218
AAU2103	X374217
AAU3378	X375108
AAU3379	X375107
C2C11646	X284227
C2C11657	X284228
C2C12070	X374666
C2C12071	X374665
C2C227281	X224688
C2C227284	X224687
C2C27298	X225346
C2C27299	X225345
C2C8343	X375468
C2C8344	X375467
C2C8350	X284228
C2C8352	X284227
C2C8357	X285098
C2C8359	X285097
C2P12432	X225346
C2P12433	X225345
C2S12636	X274046
C2S12637	X274045
C2S16488	X275020
C2S18003	X275020
C2S18004	X275019
C2S38059	X275058
C2S3806	X275057
C2S38060	X275057
C2S43448	X275030
C2S43449	X275019
C2S46538	X275058
C2S48014	X275057
JLM11716	X224488
JLM11717	X224487
JLM12422	X225186
JLM12423	X225185
JLM1827	X224488
JLM1828	X224487
JLM20927	X374666
JLM20928	X374665
JLM21461	X375214
JLM21462	X375213
JLM782	X374375
JLM783	X374376
JLM791	X375126
JLM792	X375125
T2R7687	X377062
T2R7691	X377061
XR830129	X375402
XR830130	X375401

JEEP	
5252609	X794036
5252610	X794035
5252984	X794036
5252985	X794035
05011974AA	X225232

JEEP	
05011975AA	X225231
05093180AA	X164298
05093181AA	X164297
05143692AA	X794126
05143692AB	X794126
05143693AA	X794125
05143693AB	X794125
05143702AA	X795032
05143702AB	X795032
05143703AA	X795031
05143703AB	X795031
5011972AA	X224608
5011973AA	X224607
5011974AA	X225232
5011975AA	X225231
5093180AA	X164298
5093181AA	X164297
5143692AA	X794126
5143692AB	X794126
5143693AA	X794125
5143693AB	X794125
5143702AA	X795032
5143702AB	X795032
5143703AA	X795031
5143703AB	X795031
68003697AA	X374732
68003697AC	X374732
68003707AA	X374731
68003707AC	X374731
K05011972AA	X224608
K05011973AA	X224607
K05011974AA	X225232
K05011975AA	X225231
K05093181AA	X164297
K05093180AA	X164298
K0525298A	X794036

Références d'origine Etrier

O.E.M. - OE Nummern - Codigos originales - Codici originali

KIA	
0K20A49990A	X224451
0K24049980	X224452
0K24049980A	X224452
0K24049990	X224451
0K24049990A	X224451
0K2FC49980	X775002
0K2FC49990	X775001
0K2JA33980	X774028
0K2JA33980A	X774028
0K2JA33990	X774027
0K2JA33990A	X774027
0K2N349980	X415002
0K2N349990	X415001
0K30C49980	X414006
0K30C49980A	X774020
0K30C49990	X414005
0K30C49990A	X774019
0K55233620	X774008
0K55233720	X774007
0K55333980	X774002
0K55333990	X774001
0K56A33980A	X774002
0K56A33980B	X774002
0K56A33990A	X774001
0K56A33990B	X774001
0K58A33980	X774010
0K58A33990	X774009
0K60A33980A	X774014
0K60A33980B	X774014
0K60A33990A	X774013
0K60A33990B	X774013
0K60A49980	X774014
0K60A49990	X774013
0K72F33980	X774016
0K72F33990	X774015
0K75A33980	X774016
0K75A33990	X774015
0K75B33980	X774016
0K75B33990	X774015
0K9A233980A	X224466
0K9A233980B	X224466
0K9A233980C	X224466
0K9A233980D	X224466
0K9A233980E	X224466
0K9A233980F	X224466
0K9A233990A	X224465
0K9A233990B	X224465
0K9A233990C	X224465
0K9A233990D	X224465
0K9A233990E	X224465
0K9A233990F	X224465
0K9A426980	X415002
0K9A426980A	X415002
0K9A426990	X415001
0K9A426990A	X415001
0K9A633980	X224466
0K9A633990	X224465
0K9A933980A	X224466
0K9B049980	X415002
0K9B049990	X415001
0K9D033980B	X414008
0K9D033990B	X414007
0K9D049980	X414008
0K9D049980A	X414008
0K9D049990	X414007
0K9D049990A	X414007
581101D100	X774025
581101G100	X774005
581101P000	X374727
581101Y300	X774049
581102F200	X484047
581102F300	X484047

KIA	
581102F400	X484047
581102F500	X484047
581102P700	X484053
581102PA70	X484053
581102Y000	X774029
581103E600	X774047
581103K050	X484043
581104D200	X774017
58110A6000	X774053
58110A6020	X774053
58110A6200	X774055
58110A6700	X774055
58110FDC00	X774021
581301D100	X774026
581301G100	X774006
581301P000	X374728
581301Y300	X774050
581302F200	X224450
581302F200	X484048
581302F300	X484048
581302F400	X484048
581302F500	X484048
581302P700	X484054
581302Y000	X774030
581303E600	X774048
581303K050	X484044
581304D200	X774018
58130A6000	X774054
58130A6020	X774054
58130A6200	X774056
58130A6700	X774056
58130E3100	X774004
58130FDC00	X774022
581801HA00	X774023
581801PA00	X374727
581801YA30	X774049
581802EA10	X484049
581802KA10	X484043
581802PA70	X484053
5818038A00	X484039
581803CA00	X484041
58180A6A00	X774053
58180A6A01	X774053
58180A6A20	X774055
58180A6A70	X774055
58180M3A10	X484007
581901HA00	X774024
581901PA00	X374728
581901YA30	X774050
581902CA10	X484032
581902EA10	X484050
581902KA10	X484044
581902PA70	X484054
5819038A00	X484040
581903CA00	X484042
58190A6A00	X774054
58190A6A01	X774054
58190A6A20	X774056
58190A6A70	X774056
58190M3A10	X484008
582101D100	X775013
582102F200	X485005
582102F300	X485015
582102F300	X485016
582102F400	X485015
582102K100	X485041
582102S700	X775017
582103E600	X775003
582103K050	X485013
582104D200	X775025
58210A6200	X777001
582302F200	X485006

KIA	
582302F300	X485016
582302F400	X485016
582302K100	X485042
582302S700	X775018
582303E600	X775004
582303K050	X485014
582304D200	X775026
58230A6200	X777002
583001G300	X775007
583001P300	X375449
583101HA00	X775011
583101PA30	X375449
583101Y500	X775029
583101YA50	X775029
583102EA00	X485023
583102KA10	X485041
583102SA70	X775017
58310A6A20	X777001
583111HA00	X775012
583111PA30	X375450
583111YA50	X775030
583112EA00	X485024
583112KA10	X485042
583112SA70	X775018
583113AA00	X485012
58311A6A20	X777002
583601Y500	X775030
584001G300	X775008
584001P300	X375450
BC2076R	X485016
K0BB149980	X774031
K0BB149980	X774032
K0BB149990	X774031
K72F33980	X774016
K72F33990	X774015
K75A33980	X774016
K75A33990	X774015
K75B33980	X774016
K75B33990	X774015
KK15033980D	X644066
KK15033990D	X644065
OK2N349980	X415002
OK9A426990	X415001

LANCIA	
792236	X374158
792286	X254093
792287	X254094
792337	X255059
792338	X255060
793058	X374277
793059	X374278
793060	X374277
793061	X374278
793764	X374427
793765	X374428
793766	X374427
793767	X374428
793768	X374425
793769	X374426
793770	X374425
793771	X374426
793788	X255037
793789	X255038
793790	X255037
793791	X255038
9939501	X375035
9939502	X255032
9939502	X375036
9940213	X375045
9940214	X375046
9940618	X374427
9940622	X374428
9941666	X375033
9941667	X375034
9941948	X374427
9941949	X374428
9942902	X375033
9942903	X375034
9944493	X375033
9944497	X375034
9945582	X375033
9945584	X375034
9946009	X374293
9946012	X374294
9946102	X254145
9946103	X254145
9946106	X254146
9946107	X254146
9946161	X374265
9946163	X374266
9946180	X254086
9946571	X375173
9946572	X375174
9946586	X374633
9946587	X374634
9946890	X374265
9946891	X374266
9946898	X374161
9946899	X374157
9946899	X374161
9947017	X374161
9947018	X374157
9947018	X374161
9947059	X374157
9947542	X375173
9947543	X375174
9948100	X224533
9948101	X224533
9948102	X224534
9948103	X224534
9948106	X254145
9948107	X254145
9948109	X254146
9948110	X254146
9948204	X224603
9948208	X224604

LANCIA	
9948544	X375247
9948547	X375248
9949206	X377035
9949206	X377035E
9949207	X377036
9949207	X377036E
9949283	X374645
9949284	X374646
9949538	X374589
9949539	X374590
9950437	X375033
9950438	X375034
9950477	X375033
9950478	X375034
9950589	X374265
9950592	X374266
9950602	X374267
9950603	X374268
9950709	X375033
9950710	X375034
9950866	X375033
9950871	X375034
9951096	X224603
9951099	X224604
9951111	X224475
9951114	X224476
9951213	X375247
9951214	X375248
60565767	X374157
60565768	X374158
60743084	X375035
60743085	X255032
60750962	X255032
60760115	X375045
60760116	X255032
60760116	X375046
71728817	X375291
71728818	X375292
77362367	X374639
77362368	X374640
77362372	X374637
77362373	X374638
77363359	X374637
77363360	X374638
77363362	X374639
77363363	X374640
77364336	X374637
77364337	X374638
77364339	X374639
77364340	X374640
77364538	X375247
77364540	X375248
82303553	X255049
82303554	X255050
82307315	X375115
82307316	X375116
82313847	X255049
82323193	X374347
82323194	X374348
82365081	X374117
82365081	X374161
82365082	X374118
82365082	X374157
735249500	X254145
735249501	X254146
1334622080	X374589
1334623080	X374590
4773026080	X375046
9464216180	X375291
9464216280	X375292
9566932380	X225161
9566932480	X225162

LANCIA	
K68020252AB	X165188
K68020252AB	X165198
K68020261AB	X165187
K68020261AB	X165197
LAND ROVER	
606681	X464062
606682	X464061
606694	X465004
606695	X465003
4267018	X464062
4267019	X464061
4267107	X464052
4267108	X464051
AEU1717	X465001
AEU1718	X464036
AEU1719	X464035
AEU2537	X464052
AEU2538	X464051
CAP5239	X464040
CAP5240	X464039
CAP5321	X465004
CAP5322	X465003
CAP5367	X464044
CAP5368	X464043
DSB500040	X375332
ERR4534	X225031
JPB101330	X225032
LR000568	X224664
LR000569	X224663
LR001024	X375384
LR001025	X375447
LR001025	X375448
LR001026	X375383
LR001027	X375447
LR005947	X224864
LR005948	X224863
LR005949	X464097
LR005950	X465009
LR005951	X464098
LR006763	X375447
LR006764	X375383
LR007201	X224663
LR010394	X374627
LR010395	X374628
LR010400	X374627
LR010418	X225359
LR010574	X375332
LR010575	X375331
LR015386	X224664
LR015387	X224663
LR015569	X374764
LR015570	X374763
LR015581	X375464
LR015583	X375463
LR027850	X375384
LR027851	X375383
LR039523	X284238
LR039524	X284237
LR047905	X374763
LR047906	X374764
LR10574	X375332
RTC3380	X464046
RTC3381	X464045
RTC4998	X464040
RTC4999	X464039
RTC5572	X464048
RTC5573	X464047
RTC5889	X465002
RTC5890	X465001
RTC6776	X464044
RTC6777	X464043
SEB500440	X464048

Références d'origine Etrier

O.E.M. - OE Nummern - Codigos originales - Codici originali

LAND ROVER	
SEB500450	X464047
SEB500460	X464098
SEB500470	X464097
SEG000030	X374648
SEG000060	X374647
SEG100220	X374536
SEG100230	X374535
SEG100260	X374538
SEG100270	X374537
SEG500040	X374628
SEG500041	X374628
SEG500050	X374627
SEG500051	X374627
SMC000180	X465010
SMC000190	X465009
SMC000200	X225360
SMC000210	X225359
SMC500110	X465008
SMC500240	X465007
SMC500260	X465009
SMC500270	X465010
SOB500040	X375332
SOB500042	X375332
SOB500050	X375331
SOB500052	X375331
STC1258	X464092
STC1259	X464091
STC1262	X464048
STC1263	X464047
STC1264	X465008
STC1265	X465007
STC1266	X464098
STC1267	X464097
STC1268	X465006
STC1269	X465005
STC1282	X464100
STC1283	X464099
STC1905	X375167
STC1906	X375168
STC1915	X374439
STC1916	X374440
STC1962	X464040
STC1963	X464039
LDV	
759513	X464059
CAP5105	X464093
RTC5599	X464096
RTC5600	X464095
LEXUS	
4773022460	X114008
4773030470	X135020
4773048021	X135028
4773048120	X164308
4773048140	X164308
4773050102	X644130
4773050150	X644190
4773050151	X644190
4773053030	X134062
4773053040	X135020
4775022460	X114007
4775030470	X135019
4775048021	X135027
4775048120	X164307
4775048140	X164307
4775050102	X644129
4775050120	X644189
4775050121	X644189
4775050150	X645037
4775053030	X134061
4775053040	X135019
4783048050	X165102
4783048050	X165202

LEXUS	
4785048050	X165101
4785048050	X165201
LEYLAND-DAF	
4265023	X464068
4265026	X464067
86VB002B120BA	X464067
86VB002B121BA	X464068
BAU2257	X464091
BAU2258	X464092
CAP5094	X464052
CAP5095	X464051
CAP5102	X464091
CAP5103	X464092
CAP5104	X464094
CAP5105	X464093
CAP5241	X464096
CAP5242	X464095
RTC4260	X464094
RTC4261	X464093
RTC4553	X464068
RTC4555	X464067
RTC5599	X464096
RTC5600	X464095
MAZDA	
1223615	X224602
3034573	X634002
3724210	X634001
387433610	X164144
387433710	X164143
834133980	X164092
834133990	X164091
087033980C	X164022
087033990C	X164021
0K70Y33980	X644048
0K70Y33990	X644047
0S0833980A	X644048
0S0833990A	X644047
811833980A	X164122
811833990A	X164121
817333990A	X644027
823933980A	X644028
829333980A	X644028
853233980B	X164032
853233990B	X164031
859533980A	X164124
859533980B	X164124
859533990A	X164123
859533990B	X164123
B00133980A	X644026
B00133980B	X644026
B00133980C	X644026
B00133990A	X644025
B00133990B	X644025
B00133990C	X644025
B01A2661XA	X525018
B01A2661XB	X525018
B01A2671XA	X525017
B01A2671XB	X525017
B01C3361X	X644136
B01C3371X	X644135
BOZA2698Z	X525018
BOZA2698ZA	X525018
BOZA2698ZB	X525018
BOZA2699Z	X525017
BOZA2699ZA	X525017
BOZA2699ZB	X525017
B10726980B	X165006
B10726980E	X165006
B10726990B	X165005
B10726990E	X165005
B10733610	X644060
B10733610A	X644060

MAZDA	
B10733710	X644059
B10733710A	X644059
B10733980	X644060
B10733990	X644059
B21226610	X165006
B21226710	X165005
B21226980	X165006
B21226980D	X165006
B21226990	X165005
B21226990D	X165005
B26C3361X	X644160
B26C3371X	X644159
B2ZC3398Z	X644160
B2ZC3399Z	X644159
B3YF3361X	X224684
B3YF3371X	X224683
B4603361X	X644060
B4603371X	X644059
B46033980B	X644060
B46033980B	X644092
B46033990B	X644059
B46033990B	X644091
B4623361X	X644092
B4623371X	X644091
B46233980B	X644092
B46233980C	X644092
B4623398Z	X644092
B4623398ZB	X644092
B46233990B	X644091
B46233990C	X644091
B4623399Z	X644091
B4623399ZB	X644091
B5ZF3398Z	X644072
B5ZF3399Z	X644071
B6982661X	X165140
B6982671X	X165139
BC8W3361	X644060
BC8W3361X	X644060
BC8W3361X	X644092
BC8W3371	X644059
BC8W3371X	X644091
BCZW3398Z	X644060
BCZW3398Z	X644092
BCZW3398ZA	X644060
BCZW3398ZA	X644092
BCZW3399Z	X644059
BCZW3399Z	X644091
BCZW3399ZA	X644059
BCZW3399ZA	X644091
BG6233980	X644012
BG6233980A	X644012
BG6233980B	X644012
BG6233990	X644011
BG6233990A	X644011
BG6233990B	X644011
BL5233990	X644011
BL5333980	X644012
BL5333990	X644011
BL7826980	X165006
BL7826980A	X165006
BL7826990	X165005
BL7826990A	X165005
BO1A2661XA	X525018
BO1A2661XB	X525018
BO1A2671XA	X525017
BO1A2671XB	X525017
BOXA2698ZB	X525018
BOZA2698Z	X525018
BOZA2698ZB	X525018
BOZA2699Z	X525017
BOZA2699ZB	X525017
BOZC3398Z	X644136

MAZDA	
BOZC3399Z	X644135
BPYK2661X	X225282
BPYK2661XA	X225282
BPYK2661XB	X225282
BPYK2661XC	X225446
BPYK2671X	X225281
BPYK2671XA	X225281
BPYK2671XB	X225281
BPYK2671XC	X225445
BPYK3361XA	X224602
BPYK3371XA	X224601
BPYK3371XB	X224601
BPYK3371XC	X224601
BPYK61XA	X225282
BR703361X	X644092
BR703371X	X644091
BR743361X	X644072
BR743371X	X644071
BR743398Z	X644072
BR743398ZB	X644072
BR743399Z	X644071
BR743399ZB	X644071
BR753361X	X644072
BR753371X	X644071
BR7533980B	X644072
BR7533990B	X644071
BR7626980A	X525008
BR7626980B	X525008
BR7626980C	X525008
BR7626990A	X525007
BR7626990B	X525007
BR7626990C	X525007
CB0133980	X634002
CB0133980A	X634002
CB0133980D	X634002
CB0133980E	X634002
CB0133990F	X634002
CB0133990	X634001
CB0133990D	X634001
CB0133990E	X634001
CB0133990F	X634001
CB6H33980	X634002
CB8033980	X634002
CB8033990	X634001
CB8033990A	X634001
CCY92661X	X225282
CCY92661XA	X225442
CCY92671X	X225281
CCY92671XA	X225441
D06133980B	X644068
D06133990B	X644067
DA1933980A	X644066
DA1933990A	X644065
DCZ03398Z	X414006
DCZ03398ZA	X414006
DCZ03399Z	X414005
DCZ03399ZA	X414005
DDY23361X	X224574
DDY23371X	X224573
DF1133980C	X494006
DF1133990C	X494005
DFZ13398Z	X494006
DFZ13399Z	X494005
EA2626980A	X165112
EA262698Z	X165112
EA2626990A	X165111
EA262699Z	X165111
ECZ13398ZD	X224794
ECZ13398ZE	X224794
ECZ13399ZD	X224793
ECZ13399ZE	X224793
EFY13398Z	X224794

MAZDA	
EFY13399Z	X224793
EFY13399ZA	X224793
EFY52661X	X225372
EFY52661XA	X225372
EFY52671X	X225371
EFY52671XA	X225371
EFY53361X	X224744
EFY53361XA	X224744
EFY53361XB	X224744
EFY53371X	X224743
EFY53371XA	X224743
EFY53371XB	X224743
F1Z12698Z	X675044
F1Z12699Z	X675043
F1Z13398Z	X644210
F1Z13399Z	X644209
F1Z73398Z	X644210
F1Z73399Z	X644209
FA0733980A	X164094
FA073398Z	X164094
FA0733990A	X164093
FA073399Z	X164093
FA1826980A	X165028
FA1826980B	X165028
FA182698Z	X165028
FA1826990A	X165027
FA1826990B	X165027
FA182699Z	X165027
FA6626980	X165030
FA6626990	X165029
FA6633610	X164096
FA6633710	X164095
FA6633980	X164096
FA6633990	X164095
FB0526610A	X165032
FB0526610B	X165032
FB0526710A	X165031
FB0526710B	X165031
FB0526980B	X165032
FB052698Z	X165032
FB0526990B	X165031
FB052699Z	X165031
FB0533610B	X644070
FB0533710B	X644069
FB0533980	X644070
FB0533990	X644069
FB3433980	X644070
FB3433990	X644069
FB7133980	X644070
FB7133980A	X644070
FB7133980B	X644070
FB7133980C	X644070
FB7133980D	X644070
FB7133990A	X644069
FB7133990B	X644069
FB7133990C	X644069
FB7133990D	X644069
FD012661X	X165114
FD012671X	X165113
FD012698Z	X165114
FD012699Z	X165113
FD013361XA	X644112
FD013371XA	X644111
FD133398Z	X644112
FD133399Z	X644111
FEZ52698Z	X675044
FEZ52699Z	X675043
G03033610	X164088
G03033710	X164087
G03033980	X164088
G03033990	X164087

MAZDA	
G03333610	X164088
G03333710	X164087
G03333980	X164088
G03333990	X164087
G03726610A	X165026
G03726610B	X165026
G03726610C	X165026
G03726610D	X165026
G03726710A	X165025
G03726710B	X165025
G03726710C	X165025
G03726710D	X165025
G037267110C	X165025
G09133610	X164026
G09133710	X164025
G09133980	X164020
G09133980	X164026
G09133990	X164019
G09133990	X164025
G11333980	X644092
G11333980A	X644092
G11333990	X644091
G11333990A	X644091
G15C3361X	X634008
G15C3361XA	X634008
G15C3371X	X634007
G15C3371XA	X634007
G2113361XA	X164120
G2113371XA	X164119
G23533980B	X164090
G2353398Z	X164090
G23533990B	X164089
G2353399Z	X164089
G2382661X	X165044
G2382671X	X165043
G2382698Z	X165044
G2382699Z	X165043
G3042661X	X165116
G3042671X	X165115
G51626980	X525010
G51626990	X525009
GA0233980A	X164088
GA0233980A	X644008
GA0233990A	X164087
GA0233990A	X644007
GA2A3361X	X634002
GA2A3371X	X634001
GA2E2661XA	X525010
GA2E2661XB	X525010
GA2E2661XC	X

Références d'origine Etrier

O.E.M. - OE Nummern - Codigos originales - Codici originali

MAZDA	
GAYE2661XA	X525010
GAYE2661XB	X525010
GAYE2671XA	X525009
GAYE2671XB	X525009
GAZR3398ZA	X634002
GAZR3399ZA	X634001
GB6H3399O	X634001
GE7C2661XA	X165138
GE7C2661XB	X165138
GE7C2671XA	X165137
GE7C2671XB	X165137
GE7C26980B	X165138
GE7C26980C	X165138
GE7C26980D	X165138
GE7C26990B	X165137
GE7C26990C	X165137
GE7C26990D	X165137
GEZC2698Z	X165138
GEZC2698ZA	X165138
GEZC2699Z	X165137
GEZC2699ZA	X165137
GFYP2698Z	X165138
GFYP2698ZA	X165138
GFYP2699Z	X165137
GFYP2699ZA	X165137
GFYP3398Z	X634008
GFYP3399Z	X634007
GG293398O	X164026
GG293399O	X164025
GG5B26980A	X165138
GG5B26980B	X165138
GG5B26990A	X165137
GG5B26990B	X165137
GJ252661X	X165008
GJ252671X	X165007
GJ2526980A	X165008
GJ252698Z	X165008
GJ2526990A	X165007
GJ252699ZA	X165007
GJ253361X	X164090
GJ253361XA	X164090
GJ253371X	X164089
GJ253371XA	X164089
GJ2533980B	X164090
GJ2533980C	X164090
GJ2533990B	X164089
GJ2533990C	X164089
GJ6A2661XC	X165160
GJ6A2671XA	X165159
GJ6A2671XC	X165159
GJ6A3361X	X634006
GJ6A3361XA	X634006
GJ6A3361XB	X634006
GJ6A3371X	X634005
GJ6A3371XA	X634005
GJ6A3371XB	X634005
GJ6E3361XB	X634004
GJ6E3361XC	X634004
GJ6E3371XB	X634003
GJ6E3371XC	X634003
GJ8726980A	X165008
GJ8726980B	X165008
GJ8726990A	X165007
GJ8726990B	X165007
GJZA2698ZC	X165160
GJZA2699ZB	X165159
GJZA2699ZC	X165159
GJZE3398ZC	X634004
GJZE3398ZC	X634004
GJZE3399ZB	X634003

MAZDA	
GJZE3399ZC	X634003
GJZJ2698Z	X165160
GJZJ2698ZA	X165160
GJZJ2698ZB	X165160
GJZJ2698ZC	X165160
GJZJ2699Z	X165159
GJZJ2699ZA	X165159
GJZJ2699ZB	X165159
GJZJ2699ZC	X165159
GK5933980B	X164120
GK5933990B	X164119
GK8326980B	X165044
GK8326990B	X165043
GN513398O	X164090
GN513399O	X164089
GP9A3361X	X224764
GP9A3361XA	X224764
GP9A3371X	X224763
GP9A3371XA	X224763
GS1D3361X	X494004
GS1D3371X	X494003
GS2D3398Z	X494004
GS2D3399Z	X494003
H00126610A	X165012
H00126610B	X165012
H00126710A	X165011
H00126710B	X165011
H00126980	X165012
H00126980A	X165012
H00126990A	X165011
H00126990A	X165011
H00133610	X164028
H00133710	X164027
H00133980A	X164028
H00133980B	X164028
H00133990A	X164027
H00133990B	X164027
H26226610	X165002
H26226710	X165001
H26226980	X165002
H26226990	X165001
H26626610	X165108
H26626710	X165107
HA6733610	X164126
HA6733710	X164125
HA6733980	X164126
HA6733980A	X164126
HA6733990A	X164125
HE2133980	X644002
HE2133980A	X644002
HE2133980B	X644002
HE2133980C	X644002
HE2133990	X644001
HE2133990A	X644001
HE2133990B	X644001
HE2133990C	X644001
HF3926980	X165002
HF3926990	X165001
KK15033980D	X644066
KK15033990D	X644065
L2062661X	X495002
L2062671X	X495001
L20626980C	X495002
L20626990C	X495001
L20633980A	X114004
L20633980C	X114004
L20633990A	X114003
L20633990C	X114003
L2322661X	X495002
L2322671X	X495001
L23233980B	X114004
L23233990B	X114003

MAZDA	
L2Z22698ZA	X495002
L2Z22699ZA	X495001
L2Z63398Z	X114004
L2Z63399Z	X114003
N0672661X	X525022
N0672671X	X525021
N0673361X	X644184
N0673371X	X644183
N0Z72698Z	X525022
N0Z72699Z	X525021
N0Z73398Z	X644184
N0Z73399Z	X644183
NA012661X	X525012
NA012661XA	X525012
NA012671X	X525011
NA012671XA	X525011
NA0126980	X525012
NA0126990	X525011
NA013361X	X644118
NA013371X	X644117
NA1026980	X525012
NA1026990	X525011
NA752661X	X525016
NA752661XB	X525016
NA752661XC	X525016
NA752671X	X525015
NA752671XB	X525015
NA752671XC	X525015
NA753361X	X644076
NA753371X	X644075
NAZ52698ZC	X525016
NAZ52699ZC	X525015
NAZ53398Z	X644076
NAZ53398ZA	X644076
NAZ53399Z	X644075
NAZ53399ZA	X644075
NFZ72698Z	X585042
NFZ72699Z	X585041
NFZ73398Z	X644186
NFZ73399Z	X644185
S08333610	X644048
S08333710	X644047
S08333980	X644048
S08333980A	X644048
S08333990	X644047
S08333990A	X644047
S0ZL3398Z	X644224
SOZL3399Z	X644223
SOZr3398Z	X644222
SOZR3399Z	X644221
S23133980D	X644048
S23133980E	X644048
S23133980F	X644048
S23133990D	X644047
S23133990E	X644047
S23133990F	X644047
S49K3361X	X644208
S49K3371X	X644207
S4ZR3398Z	X644208
S4ZR3399Z	X644207
S61733610	X644224
S61733710	X644223
SA3933980	X644048
SA3933980A	X644048
SA3933990	X644047
SA3933990A	X644047
SD1633610	X644222
SD1633710	X644221
TA012661X	X165110
TA012671X	X165109
TA013361X	X164234
TA013371X	X164233

MAZDA	
TA212698Z	X165110
TA212699Z	X165109
TA213398Z	X164234
TA213399Z	X164233
U0Y93398Z	X164292
U0Y93399Z	X164291
UB3933610	X164034
UB3933710	X164033
UB3933980	X164034
UB3933980A	X164034
UB3933980B	X164034
UB393398Z	X164034
UB3933990	X164033
UB3933990A	X164033
UB3933990B	X164033
UB393399Z	X164033
UB39990	X164033
UB7133980	X164034
UB7133990	X164033
UB7233980	X164034
UB7233990	X164033
UC8633610	X164204
UC8633710	X164203
UC8633980A	X164204
UC8633980B	X164204
UC8633980C	X164204
UC8633990A	X164203
UC8633990B	X164203
UC8633990C	X164203
UD1033980	X164204
UD1033990	X164203
UGY93398Z	X164296
UGY93399Z	X164295
UHY13398Z	X594004
UHY13399Z	X594003
UHY43398Z	X594004
UHY43399Z	X594003
UMY13398ZA	X674080
UMY13399ZA	X674079
UOY93398Z	X164292
UOY93399Z	X164291

MERCEDES-BENZ	
145290	X254133
145291	X254134
1956493	X374394
2669004	X254027
2669005	X254028
2669008	X254047
2669009	X254048
4200079	X374363
4200079	X374364
4200083	X374259
4200179	X374363
4200179	X374364
4200183	X374260
4204683	X225019
4204783	X225020
4204883	X374171
4204983	X374172
4205083	X224163
4205183	X224164
4205283	X224163
4205383	X224164
4205583	X374083
4205783	X374084
4205883	X224148
4205983	X224147
4206083	X224148
4206183	X374085
4206283	X374086
4206483	X374169

MERCEDES-BENZ	
4206583	X374170
4207283	X224223
4207383	X224224
4207483	X225085
4207583	X225086
4208483	X374259
4208583	X374260
4208783	X255023
4208883	X255024
4208901	X614001
4208901	X614003
4209001	X614004
4209083	X224251
4209083	X374259
4209101	X614003
4209183	X224252
4209183	X374260
4209201	X614004
4209283	X225091
4209301	X614003
4209383	X225092
4209401	X614004
4213581	X374749
4213681	X374750
4213781	X374751
4213881	X374752
4213981	X374753
4214081	X374754
4216781	X374751
4216881	X374752
4217381	X374753
4217481	X374754
4232381	X377059
4232481	X377060
4235898	X225003
4235898	X255019
4235998	X225004
4235998	X255020
4236098	X225004
4236098	X255020
4236198	X225003
4236198	X255019
4237098	X255005
4237198	X255006
4237298	X255005
4237398	X255006
4238998	X225139
4239098	X225140
4239198	X255005
4239298	X255006
4239598	X225027
4239698	X225028
14200083	X374259
14200183	X374260
14200483	X224253
14200583	X224254
14200683	X225165
14200783	X225166
14201083	X374207
14201183	X374208
14201483	X374209
14201583	X374210
14201883	X374083
14201983	X374084
14202983	X224437
14203083	X224438
14203183	X224439
14203283	X224440
14203383	X224667
14203483	X224668
14203583	X225221
14203683	X225222

MERCEDES-BENZ	
14203783	X225165
14203883	X225166
14203983	X225251
14203983	X255023
14204083	X225252
14204083	X255024
14204383	X374527
14204483	X374528
14204583	X374491
14204683	X374492
14205083	X225223
14205183	X225224
14205583	X225275
14205683	X225276
14205783	X225287
14205883	X225288
14206283	X254231
14206383	X254232
14206483	X275021
14206583	X275022
14206783	X275001
14206883	X275002
14206983	X274013
14207083	X274014
14207183	X225395
14207283	X225396
14208083	X284203
14208183	X284204
14208283	X284205
14208383	X284206
14208683	X614009
14208783	X614010
14209283	X224886
14209283	X224897
14209383	X224898
14209483	X374607
14209583	X374608
14209683	X374605
14209783	X374606
14212998	X224481
14213098	X224482
14213698	X224143
14213698	X254027
14213798	X224144
14213798	X254028
14217398	X254029
14217498	X254030
14217798	X224143
14217798	X254027
14217898	X224144
14217898	X254028
14217998	X224081
14218098	X224082
14218198	X224057
14218298	X224057
14218298	X224058
14218698	X224143
14218698	X254027
14218798	X224144
14218798	X254028
14234698	X225125
14234798	X225126
24200183	X225431
24200283	X225432
24200883	X284221
24200983	X284222
24201083	X225133
24201183	X225134
24201983	X284221
24202083	X284222
24202183	X284195
2	

Références d'origine Etrier

O.E.M. - OE Nummern - Codigos originales - Codici originali

MERCEDES-BENZ	MERCEDES-BENZ	MERCEDES-BENZ	MERCEDES-BENZ	MERCEDES-BENZ	MERCEDES-BENZ
24202383	X284157	34205483	X284110	44217898	X614003
24202483	X284158	34205483	X284144	44217998	X614004
24202583	X225331	34205783	X284157	44218298	X614001
24202683	X225332	34205883	X284158	44218398	X614002
24202783	X225311	34206183	X284223	44239298	X255006
24202783	X225312	34206283	X284224	64211798	X614001
24202883	X225311	34206383	X284225	64211898	X614002
24202883	X225312	34206483	X284226	64211998	X614001
24202983	X225211	34207183	X275045	64212098	X614002
24203083	X225212	34207283	X275046	64212098	X614004
24203483	X274061	34207383	X275039	64212198	X614001
24203483	X275069	34207483	X275040	64212198	X614003
24203583	X274062	34207583	X284109	64212298	X614002
24203583	X275070	34207583	X284143	64212298	X614004
24204183	X274067	34207683	X284110	64212398	X614003
24204283	X274068	34207683	X284144	64212498	X614004
24205783	X274013	34208583	X284099	64212998	X224187
24205883	X274014	34208683	X284100	64212998	X614001
24205983	X374719	34208783	X284087	64213098	X224188
24206083	X374720	34208883	X284088	64213098	X614002
24206183	X224490	34210098	X224149	64213198	X614001
24206183	X224491	34210098	X254059	64213298	X614002
24206283	X224489	34210198	X254060	74211598	X614001
24206283	X224492	34211098	X254077	74211698	X614002
24206583	X225391	34211198	X254078	74213198	X614001
24206683	X225392	34212498	X224289	74213298	X614002
24206783	X225449	34212598	X224290	74218398	X614003
24206883	X225450	34213998	X614003	74218498	X614004
24211898	X224143	34214098	X614004	84211898	X614003
24211898	X254027	34214198	X614001	84211998	X614004
24211998	X224144	34214298	X614002	84212098	X614003
24211998	X254028	34214398	X614001	84212198	X614004
24212398	X224143	34214498	X614002	114203783	X225165
24212398	X254027	34214598	X614003	1074200083	X224289
24212498	X224144	34214698	X614004	1074200183	X224290
24212498	X254028	34214798	X614003	1074200283	X224397
24212898	X224397	34214898	X614004	1074200383	X224398
24212998	X224398	34214998	X224187	1074200483	X224225
24213098	X254047	34214998	X614001	1074200583	X224226
24213098	X254059	34215098	X224188	1164200083	X224143
24213198	X254048	34215098	X614002	1164200183	X224144
24213198	X254060	34237498	X225249	1164200283	X254027
24213898	X614001	34237598	X225250	1164200383	X254028
24213998	X614002	34239698	X225313	1234200183	X224123
24214098	X614003	34239798	X225314	1234200183	X224149
24214198	X614004	44200583	X284243	1234200184	X224124
24215498	X224317	44200683	X284244	1234200283	X224124
24215598	X224318	44200883	X284197	1234200283	X224150
24215698	X224481	44201083	X284198	1234200383	X224123
24215798	X224482	44201783	X284243	1234200383	X254047
24231198	X225157	44201883	X284244	1234200383	X254059
24231298	X225158	44201983	X284143	1234200483	X224124
34200183	X274067	44202083	X284144	1234200483	X254048
34200283	X274068	44202383	X284143	1234200483	X254060
34202183	X374607	44202483	X284144	1234200583	X225035
34202283	X374608	44202783	X284131	1234200683	X225036
34202383	X374605	44202883	X284132	1234200783	X255005
34202483	X374606	44203183	X374605	1234200883	X255006
34202583	X374719	44203283	X374606	1234201183	X225139
34202683	X374720	44203383	X374607	1234201283	X225140
34203683	X284121	44203483	X374608	1244200083	X225059
34203983	X284122	44203983	X225351	1244200083	X225191
34204083	X224679	44204083	X225352	1244200183	X225060
34204083	X224776	44205183	X284225	1244200183	X225192
34204183	X224680	44205283	X284226	1244200283	X225125
34204183	X224775	44205383	X284131	1244200383	X225126
34204283	X225351	44205483	X284132	1264200083	X224153
34204383	X225352	44205583	X284099	1264200183	X224154
34205183	X284141	44205683	X284100	1264200283	X224153
34205283	X284142	44205783	X284087	1264200383	X224154
34205383	X284109	44205883	X284088	1264200483	X225049
34205383	X284143	44217698	X614003	1264200583	X225050
1264200683	X224183	1264200683	X254111	1264200783	X224184
1264200783	X224184	1264200783	X254112	1264200883	X224183
1264200883	X224183	1264200883	X225053	1264200883	X254111
1264200983	X224184	1264200983	X225054	1264200983	X224184
1264200983	X225054	1264200983	X254112	1264201083	X255005
1264201083	X255005	1264201083	X255019	1264201083	X255019
1264201183	X225006	1264201183	X255006	1264201183	X255006
1264201183	X255020	1264201183	X255020	1264201283	X255021
1264201283	X255021	1264201383	X255022	1264201383	X255022
1264201483	X225035	1264201483	X225035	1264201483	X225035
1264201483	X255005	1264201583	X225036	1264201583	X225036
1264201583	X255006	1264201583	X255006	1294200083	X224273
1294200083	X224273	1294200083	X224274	1294200183	X224274
1294200183	X225191	1294200283	X225191	1294200283	X225191
1294200383	X225192	1294200383	X225192	1294200383	X225192
1634200083	X404015	1634200083	X404015	1634200083	X404015
1634200183	X404016	1634200183	X404016	1634200183	X404016
1634200383	X405003	1634200383	X405003	1634200383	X405003
1634200483	X405004	1634200483	X405004	1634200483	X405004
1634210898	X284083	1634210898	X284083	1634210898	X284083
1634210998	X284084	1634210998	X284084	1634210998	X284084
1634211098	X284201	1634211098	X284201	1634211098	X284201
1634211198	X284202	1634211198	X284202	1634211198	X284202
1634211998	X284083	1634211998	X284083	1634211998	X284083
1634212098	X284084	1634212098	X284084	1634212098	X284084
1634212398	X284083	1634212398	X284083	1634212398	X284083
1634212498	X284084	1634212498	X284084	1634212498	X284084
1634230098	X285041	1634230098	X285041	1634230098	X285041
1634230198	X285042	1634230198	X285042	1634230198	X285042
1634230298	X285041	1634230298	X285041	1634230298	X285041
1634230398	X285042	1634230398	X285042	1634230398	X285042
1634230798	X285041	1634230798	X285041	1634230798	X285041
1634230898	X285042	1634230898	X285042	1634230898	X285042
1634230983	X285041	1634230983	X285041	1634230983	X285041
1634230983	X285042	1634230983	X285042	1634230983	X285042
1644200183	X224679	1644200183	X224679	1644200183	X224679
1644200183	X224680	1644200183	X224680	1644200183	X224680
1644200183	X224776	1644200183	X224776	1644200183	X224776
1644200183	X224679	1644200183	X224679	1644200183	X224679
1644200183	X224680	1644200183	X224680	1644200183	X224680
1644200183	X224775	1644200183	X224775	1644200183	X224775
1644200383	X224679	1644200383	X224679	1644200383	X224679
1644202383	X224776	1644202383	X224776	1644202383	X224776
1644202483	X224680	1644202483	X224680	1644202483	X224680
1644202483	X224775	1644202483	X224775	1644202483	X224775
1644231798	X225347	1644231798	X225347	1644231798	X225347
1644231898	X225348	1644231898	X225348	1644231898	X225348
1644232698	X225347	1644232698	X225347	1644232698	X225347
1644235398	X225348	1644235398	X225348	1644235398	X225348
1684200083	X374431	1684200083	X374431	1684200083	X374431
1684200183	X374432	1684200183	X374432	1684200183	X374432
1684200283	X374433	1684200283	X374433	1684200283	X374433
1684200383	X374434	1684200383	X374434	1684200383	X374434
1684200483	X374569	1684200483	X374569	1684200483	X374569
1684200583	X374570	1684200583	X374570	1684200583	X374570
1684200683	X375351	1684200683	X375351	1684200683	X375351
1684200783	X375352	1684200783	X375352	1684200783	X375352
1688200483	X374569	1688200483	X374569	1688200483	X374569
1694200183	X374657	1694200183	X374657	1694200183	X374657
1694200283	X374658	1694200283	X374658	1694200283	X374658
1694200383	X374669	1694200383	X374669	1694200383	X374669
1694200483	X374670	1694200483	X374670	1694200483	X374670
1694200583	X374653	1694200583	X374653	1694200583	X374653
1694200683	X374654	1694200683	X374654	1694200683	X374654
1694200783	X375381	1694200783	X375381	1694200783	X375381
1694200883	X375381	1694200883	X375381	1694200883	X375381
1694200983	X374657	1694200983	X374657	1694200983	X374657
1694201083	X374658	1694201083	X374658	1694201083	X374658
1694201183	X374669	1694201183	X374669	1694201183	X374669
1694201283	X374670	1694201283	X374670	1694201283	X374670
1694201383	X374653	1694201383	X374653	1694201383	X374653
1694201483	X374654	1694201483	X374654	1694201483	X374654
1694201583	X375381	1694201583	X375381	1694201583	X375381
1694201683	X375381	1694201683	X375381	1694201683	X375381
1694201683	X375382	1694201683	X375382	1694201683	X375382
1694201883	X374658	1694201883	X374658	1694201883	X374658
1694201883	X374659	1694201883	X374659	1694201883	X374659
1694201883	X374669	1694201883	X374669	1694201883	X374669
1694201883	X374670	1694201883	X374670	16942	

Références d'origine Etrier

O.E.M. - OE Nummern - Codigos originales - Codici originali

MERCEDES-BENZ	
9014200402	X225212
9014201701	X224492
9014201801	X224491
9014201901	X224489
9014201901	X224491
9014202001	X224490
9014202001	X224492
9014202101	X224492
9014202201	X224491
90142022202	X225211
9014202302	X225212
9014202601	X254232
9014202701	X254231
9014203301	X224489
9014203301	X224491
9014203401	X224490
9014203401	X224492
9014203901	X224491
9014204001	X224492
9014204101	X254232
9014204201	X254231
9014204401	X224492
9014204501	X224491
9014204601	X254232
9014204701	X254231
9024200502	X225133
9024200602	X225134
9024201101	X614009
9024201101	X615001
9024201201	X614010
9024201201	X615002
9024201602	X275001
9024201702	X275002
9024202202	X275001
9024202302	X275002
9044200101	X274013
9044200201	X274014
9044200801	X614009
9044200901	X614010
9044203601	X614010
9054201501	X284101
9054201601	X284102
9054202301	X284101
9054202401	X284102
2D0615423	X225133
2D0615424	X225134
2E0615101	X284099
2E0615101F	X284099
2E0615102	X284100
2E0615102F	X284100
2E0615105B	X284099
2E0615106B	X284100
A0004208901	X614001
A0024202583	X225331
A0024202683	X225332
A0034205383	X284109
A0034205483	X284110
A0034207183	X275045
A0034207283	X275046
A0034207583	X284109
A0034207683	X284110
A0034208783	X284087
A0034208883	X284088
A1644201683	X224680
A1644201983	X224679
A9044203601	X614010
BHS122E	X614003

MG	
GBC90192	X375231
GBC90193	X375232
SEG000040	X224556
SEG000050	X224555

MG	
SOB000040	X225210
SOB000050	X225209

MINI	
34106784589	X225444
34106856651	X225444
34111512777	X224581
34111512778	X224582
34116770191	X374649
34116770192	X374650
34116776919	X374707
34116776920	X374708
34116778335	X374707
34116778336	X374708
34216757247	X225273
34216757248	X225274
34216763729	X225315
34216763730	X225316
34216776925	X375411
34216776926	X375412
34216785611	X375411
34216785612	X375412

MITSUBISHI	
3345667	X374401
3345668	X374402
8602146	X374419
8602147	X374420
30863307	X374419
30863308	X374420
33456674	X374401
33456682	X374402
4100180E01	X554032
86020765	X374401
86020775	X374402
308633070	X374419
308633080	X374420
4605A065	X374681
4605A066	X374682
4605A073	X375369
4605A074	X375370
4605A177	X374419
4605A178	X374420
4605A201	X674089
4605A202	X674090
4605A257	X164317
4605A258	X164318
4605A263	X165197
4605A264	X165188
4605A264	X165198
4605A338	X674071
4605A339	X674072
4605A449	X645051
4605A450	X645052
4605A459	X644217
4605A460	X644218
4605A475	X164317
4605A476	X164318
4605A477	X165193
4605A478	X165194
4605A787	X674071
4605A788	X674072
4605A859	X164317
4605A860	X164318
4605A861	X164317
4605A862	X164318
4605A909	X645051
4605A910	X645052

M863311	X374401
M863311	X374419
M863312	X374402
M863312	X374420

MITSUBISHI	
MB044736	X644029
MB044737	X644030
MB058504	X644036
MB058505	X644035
MB150652	X644035
MB150653	X644036
MB150954	X165037
MB150955	X165038
MB151150	X644009
MB151151	X644010
MB193306	X165037
MB193306	X165038
MB193307	X165037
MB193307	X165038
MB193499	X164107
MB193500	X164108
MB193820	X165033
MB193820	X165038
MB193821	X165034
MB238247	X644051
MB238248	X644052
MB238502	X164177
MB238503	X164178
MB277194	X164097
MB277194	X164181
MB277195	X164098
MB277195	X164182
MB277196	X164181
MB277197	X164182
MB277615	X164179
MB277616	X164180
MB277878	X644003
MB277879	X644004
MB316144	X165047
MB316144	X165063
MB316145	X165048
MB316145	X165064
MB366246	X164103
MB366247	X164104
MB366960	X164103
MB366961	X164104
MB366962	X164103
MB366963	X164104
MB407656	X165045
MB407657	X165046
MB500770	X164129
MB500771	X164130
MB500772	X164127
MB500773	X164128
MB534318	X164129
MB534319	X164130
MB534320	X164127
MB534321	X164128
MB534322	X164129
MB534323	X164130
MB534546	X164127
MB534547	X164128
MB534588	X165063
MB534589	X165064
MB587023	X164097
MB587024	X164098
MB587025	X164103
MB587026	X164104
MB58775	X165064
MB58774	X165063
MB58775	X165048
MB58775	X165064
MB587793	X165063
MB587794	X165064
MB587960	X165087
MB587961	X165088
MB618002	X165085

MITSUBISHI	
MB618003	X165086
MB618577	X644003
MB618578	X644004
MB618579	X644004
MB618955	X164235
MB618956	X164236
MB699172	X164201
MB699173	X164202
MB699358	X164225
MB699359	X164226
MB699450	X164213
MB699451	X164214
MB699460	X644103
MB699461	X644104
MB699470	X644099
MB699471	X644100
MB699670	X165085
MB699671	X165086
MB699672	X165089
MB699673	X165090
MB699685	X164209
MB699686	X164210
MB699705	X164209
MB699706	X164210
MB857331	X165093
MB857332	X165094
MB857333	X165127
MB857334	X165128
MB857833	X164219
MB857834	X164220
MB857838	X164219
MB857839	X164220
MB858392	X164227
MB858393	X164228
MB858404	X164227
MB858405	X164228
MB858406	X164227
MB858407	X164228
MB858464	X165057
MB858465	X165058
MB895304	X645005
MB895305	X645006
MB928036	X644101
MB928037	X644102
MB928259	X165081
MB928260	X165082
MB928286	X164215
MB928287	X164216
MB928408	X164215
MB928409	X164216
MB928410	X164217
MB928411	X164218
MB928422	X644105
MB928423	X644106
MB928424	X644107
MB928425	X644108
MB928827	X164216
MB950066	X165117
MB950067	X165118
MB950176	X164207
MB950177	X164208
MB950193	X165091
MB950194	X165092
MB950195	X165051
MB950196	X165052
MB950197	X165091
MB950198	X165092
MB950351	X165121
MB950352	X165122
MN116309	X165167
MN116310	X165168
MR129142	X164285

MITSUBISHI	
MR129143	X164286
MR129583	X165051
MR129584	X165052
MR205146	X165081
MR205147	X165082
MR205252	X164239
MR205253	X164240
MR205258	X164239
MR205259	X164240
MR205260	X164237
MR205261	X164238
MR205262	X165123
MR205263	X165124
MR235664	X165119
MR235665	X165120
MR249082	X164239
MR249083	X164240
MR249161	X164238
MR249161	X164325
MR249162	X164237
MR249162	X164326
MR249220	X374399
MR249221	X374400
MR249222	X374401
MR249223	X374402
MR249964	X164207
MR249965	X164208
MR307413	X645019
MR307414	X645020
MR370775	X164207
MR370776	X164208
MR407675	X644177
MR407676	X644178
MR449851	X644149
MR449852	X644150
MR475591	X165165
MR475592	X165166
MR475867	X164217
MR475868	X164218
MR493783	X165127
MR493784	X165128
MR510537	X644151
MR510538	X644152
MR510541	X165147
MR510542	X165148
MR510889	X164239
MR510890	X164240
MR510892	X164240
MR527670	X164287
MR527671	X164288
MR527977	X674083
MR527978	X674084
MR955063	X164287
MR955064	X164288
MR955065	X165169
MR955066	X165170
MR955245	X375233
MR955246	X375234
MR977362	X674077
MR977363	X674078

NISSAN	
4100110	X554028
4100113E00	X674013
4100113E00	X674014
4100113	X674014
4100188E00	X554010
4101110	X554027
4101113E00	X674013
4101113	X674013
4101113E00	X674014
4101188E00	X554009
4101130	X254224

NISSAN	
6903085	X254223
4100113E01	X674013
41001130	X674014
4100113E01	X674014
41001800	X554032
4100188E01	X554010
41011130	X674013
4101113E01	X674013
4101113E01	X674014
4101180E01	X554031
41011800	X554031
4101188E01	X554009
4400161E01	X555014
4401161E01	X555013
69030840	X254224
69030850	X254223
4100113E02	X674014
410013100	X674014
4100188E02	X554010
410113100	X674013
4101188E02	X554009
4100121900	X554030
4400108E90	X675016
4401108E90	X675015
4000171J00	X374282
4100001P00	X644096
4100008N00	X554018
4100008N01	X554018
4100008N02	X554018
4100008N03	X554018
4100009W06	X554048
4100009W11	X674013
4100009W12	X674013
410000F002	X374394
4100016R10	X164012
4100016R11	X164012
410004A00A	X554064
410007C000	X374450
410007F000	X374424
410009C000	X254160
410009C001	X254160
410009C002	X254160
41000C7164	X374396
41000D1410	X164058
41000M3701	X674010
4100	

Références d'origine Etrier

O.E.M. - OE Nummern - Codigos originales - Codici originali

NISSAN	
410010M800	X554040
410010N600	X164200
4100110G01	X554036
4100110G02	X554036
4100116R91	X164012
410011F500	X374604
410011F501	X374604
410011KC2C	X554060
4100120J00	X554046
4100120J01	X554046
4100125T00	X554034
4100125T01	X554034
4100125T11	X554034
4100126L91	X164282
410012F021	X374418
410012F521	X374418
410012F522	X374418
410012N300	X554042
4100137J00	X644120
4100137P00	X644110
4100137P01	X644110
4100138U00	X554028
410013F000	X374282
410014A00C	X554064
410014M510	X374418
410014U100	X374584
4100154C01	X164200
4100154C02	X164200
4100154C03	X164200
4100156L11	X554048
4100157C00	X554040
4100157C00	X554042
4100157G00	X554036
4100158A01	X554014
4100158Y00	X164140
4100160Y00	X554012
4100160Y01	X554012
4100160Y02	X554012
4100161A00	X674006
4100161A01	X674006
4100162A00	X674006
4100162A01	X674006
4100167R00	X164140
4100170J00	X254162
4100171J00	X374282
4100176A00	X554024
4100177S00	X644018
4100177S06	X644018
410017F000	X374424
410017F00A	X374424
410018H300	X164272
410018H30A	X164272
4100194M10	X554026
4100199B00	X374290
410019F500	X224746
410019X225	X274048
41001AX601	X374596
41001AX60A	X374596
41001C7801	X374396
41001C7811	X374396
41001C7812	X554044
41001C9600	X554044
41001CC00A	X554058
41001CD000	X284184
41001CD00B	X284184
41001EB30A	X554054
41001EB32A	X554056
41001EG50A	X554058
41001EM10A	X554068
41001ET00A	X554062
41001G4090	X164192
41001G4091	X164192

NISSAN	
41001G9804	X374396
41001JD00A	X164300
41001JN00A	X554060
41001M0890	X164030
41001MB200	X284092
41001MB225	X284092
41001MB600	X284182
41001MB60A	X284182
41001ON600	X164200
41001T7890	X554020
41001VB200	X554050
41001VC700	X554050
41001VJ500	X554036
41001VK100	X554052
41001VL30A	X554036
41001VL30C	X554052
41001VS40A	X554050
41001ZS60A	X554056
4101001P00	X644095
4101008N00	X554017
4101008N01	X554017
4101008N02	X554017
4101008N03	X554017
4101009W06	X554047
4101009W11	X674014
4101009W12	X674014
410100F002	X374393
4101016R10	X164011
4101016R11	X164011
410104A00B	X554063
410107C000	X374449
410107F000	X374423
410109C000	X254159
410109C001	X254159
410109C002	X254159
41010C7164	X374395
41010D1410	X164057
41010M3701	X674009
41010M6600	X674025
41010M7900	X674023
41010N4400	X644083
41010OF002	X374393
41010P7201	X644089
41010R9000	X554017
41010U9501	X674017
41010U9502	X674017
41010Y9502	X254159
41010Y9600	X254159
4101100Q0K	X284171
4101100QAD	X274051
4101100QAE	X274065
4101100QAF	X374453
4101100QAG	X274003
4101101J01	X554045
4101104C02	X554015
4101104C03	X554015
4101105A01	X674005
4101105A90	X554013
4101105A90	X674005
4101107S91	X644017
4101108N01	X554015
4101108N02	X554015
4101108N03	X554015
4101109W00	X554047
410110M600	X554039
410110M800	X554039
410110N600	X164199
4101110G01	X554035
4101110G02	X554035
4101116R91	X164011
410111F500	X374603
410111F501	X374603

NISSAN	
410111KC2C	X554059
4101120J00	X554045
4101120J01	X554045
4101121P00	X554029
4101125T00	X554033
4101125T01	X554033
4101125T11	X554033
4101126L91	X164281
410112F021	X374417
410112F521	X374417
410112F522	X374417
410112F52A	X374417
410112F52A	X374418
410112N300	X554041
4101132R00	X374201
4101132R01	X374201
4101137J00	X644119
4101137P00	X644109
4101137P01	X644109
4101138U00	X554027
410113F000	X374281
4101144F00	X374201
4101144F01	X374201
410114A00B	X554063
410114M510	X374417
410114U100	X374583
4101154C01	X164199
4101154C02	X164199
4101154C03	X164199
4101156L11	X554047
4101157C00	X554041
4101157G00	X554035
4101158A01	X554013
4101158Y00	X164139
4101160Y00	X554011
4101160Y01	X554011
4101160Y02	X554011
4101161A00	X674005
4101161A01	X674005
4101162A00	X674005
4101162A01	X674005
4101167R00	X164139
4101170J00	X254161
4101171J00	X374281
4101176A00	X554023
4101177S00	X644017
4101177S06	X644017
410117F00A	X374423
410118H300	X164271
410118H30A	X164271
4101194M10	X554025
4101199B00	X374289
410119F500	X224745
410119X225	X274047
41011AX601	X374595
41011AX60A	X374595
41011C7801	X374395
41011C7811	X374395
41011C7812	X374395
41011C9600	X374395
41011CC00A	X554057
41011CD000	X284183
41011CD00B	X284183
41011EB30A	X554053
41011EB32A	X554055
41011EG50A	X554057
41011EM10A	X554067
41011ET00A	X554061
41011G4090	X164191
41011G4091	X164191
41011G9803	X374395

NISSAN	
41011JD00A	X164299
41011JN00A	X554059
41011M0890	X164029
41011MB200	X284091
41011MB225	X284091
41011MB600	X284181
41011MB60A	X284181
41011OM600	X554039
41011OM800	X554039
41011ON600	X164199
41011T7890	X554019
41011VB200	X554049
41011VC700	X554049
41011VJ500	X554035
41011VK100	X554051
41011VL30A	X554035
41011VL30C	X554051
41011VS40A	X554049
41011ZS60A	X554055
4111001B00	X674016
4111001B01	X674016
4111001B01	X674058
4111017B00	X674058
4111017B01	X674058
411117C325	X374450
411117F025	X374424
411119C125	X374394
411119C126	X374394
411119X425	X254252
41111PC125	X374394
4111127C325	X374449
411127F025	X374423
411129C125	X374393
411129C126	X374393
411129X425	X254251
4112001B00	X674015
4112001B01	X674015
4112001B01	X674057
4112017B00	X674057
4112017B01	X674057
4400001P04	X675024
4400100Q0C	X285082
4400100Q0D	X285070
4400100Q0J	X285082
4400100QAA	X275024
4400100QAB	X275024
4400100QAC	X375198
4401105J00	X165133
4401107P90	X675027
440110M800	X555009
440110N600	X555011
440111AA0A	X165203
440111KDOA	X165175
4401121F90	X675003
440112F500	X375149
440112F600	X375149
4401131U10	X555015
4401131U13	X555015
4401132G00	X165105
4401137P00	X165103
440113F010	X375089
440113Y500	X555021
440113Y501	X555021
4401144F00	X165077
440114EA0A	X377055
440114U100	X375321
4401150A00	X165039
4401154C01	X555005
4401154C01	X555005
4401158Y00	X165083
440115M50A	X555011
440115Y500	X555021
440115Y50A	X555021
4401160Y00	X165079
4401162C00	X555003
4401164G00	X165105
4401170J00	X375089
4401171J00	X375091
4401171J01	X375091
4401178N00	X555007
440118F800	X375149
440118H300	X165145

NISSAN	
4400162C00	X555004
4400164G00	X165106
4400170J00	X375090
4400171J00	X375092
4400171J01	X375092
4400178N00	X555008
4400187N01	X555008
440018F800	X375150
440018H300	X165146
440018H30A	X165146
4400199B02	X375122
44001AL500	X165182
44001AV700	X225286
44001BM400	X375274
44001BM40A	X375274
44001BM500	X375272
44001BU000	X375274
44001CB10A	X165182
44001CD000	X285088
44001CD00A	X285088
44001CN11A	X165182
44001EB30A	X555024
44001EM11A	X165176
44001JG00A	X165196
44001MA000	X285048
44001MA00A	X285048
44001OM800	X555010
44001V1490	X555026
44001VB200	X555020
44001VC700	X555020
44001VS40A	X555020
4401001P04	X675023
4401100Q0C	X285069
4401100Q0D	X285081
4401100QAA	X275023
4401100QAB	X275023
4401100QAC	X375198
4401105J00	X165133
4401107P90	X675027
440110M800	X555009
440110N600	X555011
440111AA0A	X165203
440111KDOA	X165175
4401121F90	X675003
440112F500	X375149
440112F600	X375149
4401131U10	X555015
4401131U13	X555015
4401132G00	X165105
4401137P00	X165103
440113F010	X375089
440113Y500	X555021
440113Y501	X555021
4401144F00	X165077
440114EA0A	X377055
440114U100	X375321
4401150A00	X165039
4401154C01	X555005
4401154C01	X555005
4401158Y00	X165083
440115M50A	X555011
440115Y500	X555021
440115Y50A	X555021
4401160Y00	X165079
4401162C00	X555003
4401164G00	X165105
4401170J00	X375089
4401171J00	X375091
4401171J01	X375091
4401178N00	X555007
440118F800	X375149
440118H300	X165145

NISSAN	
440118H30A	X165145
4401199B02	X375121
44011AL500	X165181
44011AV700	X225285
44011BM400	X375273
44011BM40A	X375273
44011BM500	X375271
44011BU000	X375273
44011CB10A	X165181
44011CD000	X285087
44011CD00A	X285087
44011CN11A	X165181
44011EB30A	X555023
44011EM11A	X165175
44011JG00A	X165195
44011MA000	X285047
44011MA00A	X285047
4	

Références d'origine Etrier

O.E.M. - OE Nummern - Codigos originales - Codici originali

OPEL		OPEL		OPEL		OPEL		OPEL		OPEL	
542042	X374078	542109	X225406	542212	X104008	542287	X225113	542548	X275047	3669055	X104019
542043	X274105	542110	X225407	542212	X104021	542287	X225295	542549	X275048	3669056	X104020
542044	X375240	542111	X225408	542213	X104022	542288	X224528	542550	X274099	4241469	X225026
542045	X225051	542113	X274107	542213	X224059	542289	X224527	542551	X274100	4243218	X225025
542046	X225052	542114	X274108	542214	X104021	542290	X224530	542555	X225023	4300890	X164198
542047	X375239	542116	X164223	542214	X224060	542291	X224529	542556	X225024	4300891	X164197
542048	X375258	542121	X375427	542215	X104001	542292	X224522	554264	X375266	4314370	X164198
542049	X164117	542122	X375428	542216	X104002	542293	X224521	555263	X375265	4314371	X164197
542051	X164197	542123	X375423	542217	X224151	542296	X275003	1605076	X375241	4402988	X274051
542053	X164118	542124	X375424	542218	X224152	542297	X275004	1605076	X375242	4402990	X274052
542055	X224087	542126	X375305	542221	X104017	542298	X275005	1605078	X375239	4403459	X275023
542056	X224088	542127	X375306	542222	X104018	542299	X275006	1605078	X375240	4403460	X275024
542057	X224399	542131	X375425	542223	X104009	542300	X275007	1605114	X375241	4403463	X275024
542058	X224400	542132	X375426	542224	X104010	542301	X275008	1605114	X375242	4405525	X274065
542059	X224071	542134	X794085	542225	X104019	542302	X225233	1605116	X375239	4405526	X274066
542059	X224073	542135	X375423	542226	X104020	542303	X225234	1605116	X375240	4405539	X275023
542059	X224399	542136	X374057	542229	X225025	542304	X275003	1605118	X375257	4405544	X275024
542060	X224072	542137	X375424	542229	X225079	542305	X275004	1605118	X375258	4414022	X374454
542060	X224074	542140	X374059	542230	X275080	542306	X275005	1605119	X375239	4414023	X374453
542060	X224400	542142	X374691	542231	X224045	542307	X275006	1605119	X375240	4414026	X375198
542061	X104025	542143	X374692	542232	X224046	542308	X275007	1605968	X375241	4414027	X375197
542062	X104026	542144	X484057	542233	X224037	542309	X275008	1605968	X375242	4414622	X375260
542063	X224073	542145	X484058	542234	X224038	542312	X225219	1605970	X375257	4414623	X375259
542064	X224074	542146	X484059	542237	X224061	542377	X225423	1605970	X375258	4418034	X375259
542065	X224073	542147	X374077	542238	X224062	542378	X225424	1605971	X375239	4418035	X375260
542065	X224165	542148	X374077	542241	X224195	542389	X225415	1605971	X375240	4419941	X284171
542066	X224074	542149	X484060	542242	X224196	542394	X225416	3487155	X104023	4419942	X284172
542066	X224166	542150	X375429	542243	X224195	542395	X225413	3487156	X104024	4420056	X285069
542067	X225057	542151	X375430	542244	X224196	542396	X225414	3487163	X104025	4420057	X285070
542067	X225067	542152	X375429	542245	X224229	542397	X225415	3487164	X104026	4421281	X285081
542068	X225058	542153	X375430	542246	X224230	542398	X225416	3487288	X104013	4421282	X285082
542068	X225068	542154	X375431	542247	X164223	542409	X375305	3487289	X104014	4482543	X224276
542069	X104013	542156	X375432	542248	X164224	542410	X375306	3487290	X104015	4482550	X224275
542070	X104014	542157	X484060	542250	X224046	542450	X374179	3487290	X104016	4501214	X274049
542071	X374519	542159	X484059	542251	X224045	542451	X374180	3487291	X104015	4501215	X274050
542072	X374520	542160	X224429	542252	X224046	542452	X224521	3487331	X104001	4611539	X225163
542073	X104015	542161	X224430	542253	X225025	542453	X224522	3487332	X104002	4611547	X225164
542074	X104016	542164	X275047	542254	X225026	542453	X224530	3487356	X104011	4611554	X224429
542075	X224025	542165	X275048	542255	X225023	542454	X375265	3487356	X104012	4611562	X224430
542076	X224026	542166	X375429	542256	X225024	542455	X375266	3487357	X104012	4701929	X274057
542077	X224395	542167	X375430	542257	X225075	542458	X224521	3487376	X104007	4701930	X274058
542078	X224396	542168	X375431	542258	X225076	542459	X224522	3487377	X104008	4706756	X274059
542079	X104001	542169	X375432	542259	X225073	542459	X224530	3487378	X104003	4706757	X274060
542080	X104002	542170	X375425	542260	X225074	542461	X374503	3487378	X104022	4708234	X374672
542081	X104011	542171	X375426	542261	X225069	542462	X374504	3487379	X104004	4708243	X374671
542082	X104012	542173	X375423	542262	X225070	542463	X375241	3487379	X104021	4804640	X485019
542083	X224032	542174	X375424	542265	X165055	542464	X375242	3487380	X104001	4804641	X485020
542083	X224338	542175	X375425	542266	X165056	542465	X375257	3487381	X104002	4804843	X225453
542084	X224031	542176	X375426	542267	X165055	542466	X375258	3487987	X104017	4804844	X225454
542084	X224337	542177	X375423	542268	X165056	542467	X375239	3487988	X104018	4805461	X164330
542085	X374518	542178	X375424	542269	X224037	542468	X375240	3487989	X104009	4805462	X164329
542086	X274106	542180	X375431	542270	X224038	542469	X224707	3487990	X104010	4807984	X485020
542087	X224201	542181	X375432	542271	X225113	542470	X224708	3487991	X104019	4808054	X485019
542088	X224202	542186	X374058	542271	X225295	542471	X224429	3487992	X104020	4808843	X484051
542089	X225067	542187	X375423	542272	X225114	542471	X224521	3669025	X104005	4808844	X484052
542090	X225068	542188	X375424	542272	X225296	542472	X224430	3669026	X104006	4808859	X484051
542092	X225278	542189	X374059	542273	X224429	542472	X224522	3669027	X104013	4808860	X484052
542093	X225277	542190	X374060	542273	X224521	542473	X375301	3669028	X104014	4808863	X485019
542094	X225304	542192	X225405	542274	X224430	542474	X375302	3669033	X104023	4808864	X485020
542095	X225303	542193	X225406	542274	X224522	542475	X375303	3669034	X104024	4838967	X224429
542096	X375305	542196	X375429	542275	X225163	542476	X375304	3669039	X104001	4838975	X224430
542097	X224059	542197	X374078	542276	X225164	542477	X225339	3669040	X104002	4838983	X225163
542098	X224060	542198	X375430	542277	X164117	542478	X225340	3669043	X104011	4838991	X225164
542099	X224275	542199	X375431	542278	X165152	542479	X225401	3669044	X104012	5391990	X224521
542100	X224276	542202	X374078	542279	X165151	542539	X224626	3669045	X104007	5392006	X224522
542101	X374179	542203	X104023	542280	X225220	542540	X224625	3669046	X104008	5392014	X224521
542102	X374180	542204	X104024	542281	X225219	542542	X274077	3669049	X104003	5392022	X224522
542103	X224428	542205	X375432	542283	X165055	542543	X274078	3669050	X104004	5442280	X225220
542104	X224427	542207	X224379	542284	X165056	542544	X274071	3669051	X104017	5510384E00	X274060
542106	X375306	542208	X224380	542285	X794086	542545	X274072	3669052	X104018	5510484E00	X274059
542107	X164224	542211	X104007	542286	X225114	542546	X275047	3669053	X104009	5542000	X164198
542108	X225405	542211	X104022	542286	X225296	542547	X275048	3669054	X104010	5542001	X275003

Références d'origine Etrier

O.E.M. - OE Nummern - Codigos originales - Codici originali

OPEL	
5542002	X275004
5542003	X275005
5542004	X275006
5542005	X374517
5542006	X374503
5542007	X374504
5542009	X794085
5542060	X224527
5542061	X224528
5542062	X224529
5542062	X224530
5542063	X224530
5542064	X224521
5542065	X224522
5542085	X374518
5542095	X274071
5542096	X274072
5542097	X274079
5542098	X274080
5542099	X274099
5542100	X274100
5542103	X275047
5542104	X275048
5542106	X224429
5542107	X224430
5542110	X224703
5542111	X224704
5542114	X225278
5542115	X225277
5542116	X225304
5542117	X225303
5542118	X225338
5542119	X225337
5542259	X275023
5542260	X275024
5542263	X375265
5542264	X375266
5542265	X225403
5542266	X225404
5542267	X225337
5542268	X225338
5542269	X375265
5542270	X375266
5542275	X375239
5542276	X375240
5542277	X225303
5542278	X225304
5542450	X225402
5542451	X375367
5542452	X375368
5542453	X224529
5542454	X224530
5542455	X224625
5542456	X224626
5542457	X224693
5542458	X224694
5542464	X375306
5542465	X375305
5542469	X224429
5542470	X224430
8828931	X224275
8828949	X224276
8828964	X225026
9110988	X274051
9110988	X274052
9110990	X274052
9111459	X275023
9111460	X275024
9111463	X275024
9118110	X275003
9118111	X275004
9118112	X275005

OPEL	
9118113	X275006
9118536	X225219
9118537	X225220
9121358	X274065
9121359	X274066
9121372	X275023
9121377	X275024
9161514	X274049
9161515	X274050
9192454	X224521
9192455	X224522
9193976	X275003
9193977	X275004
9193978	X275005
9193979	X275006
9193980	X275007
9193981	X275008
9195053	X225233
9195054	X225234
9195321	X274057
9195322	X274058
9195982	X374519
9195983	X374520
9195986	X374517
9195987	X374518
9196051	X374503
9196452	X275003
9196453	X275004
9196454	X275005
9196455	X275006
9196456	X275007
9196457	X275008
9199254	X374454
9199255	X374453
9199259	X375197
9199260	X375198
9200127	X375265
9200128	X375266
9214007	X274060
9214008	X274059
9496457	X275008
11175379	X224128
11175389	X224127
13273621	X284146
13273623	X284145
13275846	X375429
13275847	X375430
13275927	X375431
13275928	X375432
13275929	X375425
13275930	X375426
13275931	X375423
13275932	X375424
13276172	X374691
13276173	X374692
13279638	X484057
13279639	X484058
13300861	X225405
13300862	X225406
13300863	X225405
13300864	X225406
13300883	X225407
13300884	X225408
13300885	X225423
13300886	X225424
13301189	X274105
13301190	X274106
13301226	X274107
13301227	X274108
13338347	X375427
13338348	X375428
13338349	X375423

OPEL	
13338350	X375424
13343563	X375425
13343564	X375426
13343565	X375423
13343566	X375424
13343567	X375429
13343568	X375430
13343569	X375431
13343570	X375432
13370457	X375425
13370458	X375426
13370459	X375423
13370460	X375424
13370461	X375429
13370462	X375430
13370463	X375431
13370464	X375432
13370467	X375423
13370468	X375424
13390031	X375429
13390032	X375430
13390033	X375431
13390034	X375432
13417969	X225415
13417970	X225416
13417971	X225413
13417972	X225414
13417973	X225415
13417974	X225416
13578803	X484060
13578804	X484059
18024956	X794085
18024957	X794086
18027956	X794085
18029935	X165152
18029936	X165151
20993775	X485020
20993776	X485019
34887331	X104001
42548181	X285021
42548182	X285022
42554758	X285051
42554759	X285052
90094929	X104023
90094930	X104024
90166223	X224025
90166224	X224026
90166227	X224395
90166228	X224396
90167262	X104005
90167263	X104006
90187521	X224031
90187522	X224032
90295000	X225023
90295001	X225024
90297533	X225080
90297534	X225079
90297765	X224045
90297766	X224046
90297775	X224037
90297776	X224038
90348257	X225075
90348258	X225076
90348302	X225073
90348303	X225074
90348305	X224061
90348306	X224062
90369384	X374179
90369385	X374180
90421729	X224195
90421730	X224196
90421739	X224195

OPEL	
90421740	X224196
90421744	X224229
90421745	X224230
90444700	X374179
90444701	X374180
90487042	X224045
90487043	X224046
90487045	X224037
90487046	X224038
90509196	X224427
90509197	X224428
90509203	X225113
90509203	X225295
90509205	X225114
90509205	X225296
90540167	X224430
90540167	X224522
90540168	X224429
90540168	X224521
90540170	X225163
90540171	X225164
90543586	X225113
90543586	X225295
90543587	X225114
90543587	X225296
90543996	X224527
90544002	X224529
90544003	X224530
90544026	X224521
90544027	X224522
91032969	X374059
91032970	X374060
91073220	X224088
91073221	X224087
92173327	X375265
93142924	X224704
93146084	X375239
93167542	X284171
93167543	X284172
93167652	X285069
93167653	X285070
93168711	X375305
93168712	X375306
93169542	X284171
93169543	X284172
93170598	X375241
93170599	X375242
93170604	X375257
93170605	X375258
93170606	X375239
93170607	X375240
93171069	X375241
93171069	X375242
93171071	X375239
93171071	X375240
93172168	X224703
93172169	X224704
93172170	X224635
93172171	X224636
93172182	X225277
93172183	X225278
93172184	X225303
93172185	X225304
93172186	X225403
93172187	X225404
93172297	X225337
93172298	X225338
93172924	X224704
93173240	X224530
93173271	X224521
93173273	X224522
93173311	X275023

OPEL	
93173313	X275024
93173327	X375265
93173329	X375266
93173731	X224521
93173732	X224522
93174804	X375260
93174805	X375259
93175248	X375241
93175248	X375242
93175250	X375239
93175250	X375240
93176080	X375241
93176081	X375242
93176082	X375257
93176083	X375258
93176084	X375239
93176085	X375240
93176086	X375258
93176426	X224429
93176426	X224521
93176427	X224430
93176427	X224522
93176621	X375241
93176621	X375242
93176623	X375240
93176623	X375240
93179154	X375301
93179155	X375302
93179156	X375303
93179157	X375304
93179158	X375305
93179159	X375306
93181404	X225339
93181405	X225340
93183696	X375367
93183697	X375368
93184517	X224529
93184518	X224530
93185745	X224625
93185746	X224626
93186061	X375306
93186062	X375305
93187986	X225303
93187987	X225304
93189695	X224429
93189696	X224430
93189797	X274071
93189801	X274079
93189802	X274080
93189806	X274100
93189817	X275047
93189818	X275048
93190679	X225338
93190681	X225337
93190822	X224625
93191695	X274071
93191696	X274072
93192386	X375259
93192387	X375260
93192463	X275047
93192464	X275048
93192465	X275047
93192466	X275048
93192746	X224521
93192747	X224522
93192893	X274099
93192894	X274100
93192955	X374672
93192956	X374671
93199805	X274099
94316097	X164198
94316098	X164197

OPEL	
94388012	X164198
94388013	X164197
94388014	X164198
94388015	X164197
94388016	X164118
94388017	X164117
95507101	X285081
95507102	X285082
95508656	X224429
95508657	X224430
95508711	X275047
95508712	X275048
96192182	X224195
96192183	X224196
96193089	X224045
96193090	X224046
96226977	X224195
96226978	X224196
96626050	X485019
96626051	X485020
96626073	X485019
96626074	X485020
97035248	X164224
97035249	X164223
97144476	X165056
97035259	X165055
97039050	X165056
97039051	X165055
97065350	X164118
97065351	X164117
97144476	X164224
97144477	X164223
97144478	X165056
97144479	X165055
97172923	X224703
897035248	X164224
904877046	X224038
7701205763	X274049
7701205764	X274050
8970352480	X164224
8970352490	X164223
8970352580	X165056
8970352590	X165055
8970352591	X165055
8971444760	X164224
8971444770	X164223
8971444780	X165056
8971444790	X165055
9871444770	X164223

PORSCHE

477615107	X224409
477615108	X224410
91135142502	X224297
91135142503	X224407
91135142602	X224298
91135142603	X224408
91135190700	X224307
91135190800	X224308
91135242500	X225123
91135242600	X225124
91135290700	X225121
91135290800	X225122
91435204313	X225147
91435204413	X225148
91435242300	X225137
91435242400	X225138
92835142501	X224413
92835142601	X224414

Références d'origine Etrier

O.E.M. - OE Nummern - Codigos originales - Codici originali

PORSCHE	
92835242501	X225155
92835242601	X225156
94435142900	X224411
94435143000	X224412
94435242900	X225129
94435243000	X225130
95135142100	X284017
95135142200	X284018
95135242100	X285007
95135242200	X285008
311615107B	X224063
311615108B	X224064
PSA (PEUGEOT/CITROËN)	
4401E0	X374573
4401E1	X374574
440017	X374315
440018	X374316
440019	X375015
440019	X375099
440020	X375098
440025	X374311
440026	X374312
440027	X254153
440028	X254154
440029	X375099
440030	X375100
440036	X375015
440037	X375016
440037	X375098
440042	X224145
440043	X224146
440044	X374333
440045	X374334
440046	X374275
440047	X374276
440048	X224109
440049	X224110
440052	X224107
440052	X224107
440052	X224107
440052	X224108
440052	X224108
440052	X224108
440053	X224107
440053	X224108
440053	X224108
440053	X224108
440056	X254011
440057	X254012
440064	X375017
440065	X375018
440066	X374011
440067	X374012
440068	X254057
440068	X254087
440069	X254058
440075	X254013
440076	X254014
440077	X254043
440078	X254044
440079	X254089
440080	X255026
440081	X254079
440082	X254080
440083	X374003
440083	X374003
440084	X374004
440084	X374004
440084	X374004
440085	X374013
440086	X374014
440087	X374039
440087	X374333
440088	X374040
440088	X374334
440089	X254113

PSA (PEUGEOT/CITROËN)	
440089	X254113
440090	X254114
440090	X254114
440091	X374159
440091	X374159
440092	X374160
440092	X374160
440093	X254087
440094	X254058
440094	X254058
440094	X254088
4401E2	X374575
440100	X374575
440101	X374573
440110	X374574
440137	X254183
440138	X254184
440147	X254187
440148	X254188
440149	X254083
440150	X254084
440157	X254045
440157	X254155
440158	X254046
440158	X254156
440159	X254045
440160	X254046
440161	X255007
440161	X255051
440162	X255008
440162	X255052
440163	X374007
440163	X374007
440164	X374008
440164	X374008
440164	X374008
440165	X375041
440165	X375041
440166	X375042
440167	X374257
440168	X374258
440170	X375041
440171	X375042
440172	X375031
440173	X375032
440176	X374235
440177	X374236
440178	X374255
440178	X374255
440178	X374255
440178	X374255
440179	X374256
440179	X374256
440180	X374223
440181	X374224
440182	X374225
440183	X374226
440184	X374227
440185	X374228
440186	X374229
440187	X374230
440188	X374231
440189	X374232
440190	X374233
440191	X374234
440192	X374293
440193	X374294
440194	X374257
440195	X374258
440196	X374379
440197	X374380
440197	X374380
440198	X374381
440199	X374382
441001	X224209
441001	X224209

PSA (PEUGEOT/CITROËN)	
441002	X224210
441002	X224210
441003	X254087
441004	X254088
441007	X255051
441008	X255052
441043	X274005
441044	X274006
441045	X274009
441046	X274010
441047	X274025
441048	X274026
441055	X225159
441056	X225160
441059	X224247
441060	X224248
441061	X274007
441062	X274008
441063	X274011
441064	X274012
441065	X255033
441065	X255033
441066	X255034
441066	X255034
441067	X274023
441068	X274024
441069	X374405
441070	X374406
441071	X254207
441072	X254208
444840	X254011
444841	X254012
4401E3	X374576
5417795	X314017
5417796	X314018
5455898	X315014
5468767	X315003
5468767	X315004
7545165	X374159
7545166	X374160
9937779	X374011
9945781	X374223
9945782	X374224
9945791	X374225
9945792	X374226
9945793	X374227
9945794	X374228
9945795	X374227
9945796	X374227
9945796	X374228
9945797	X374228
9945800	X374229
9945801	X374230
9945804	X374231
9945805	X374232
9945813	X374233
9945814	X374234
4400E4	X224247
44000000	X224247
4401E4	X284045
4401E4	X284045
75515980	X314015
75515980	X314016
75522650	X374465
95498695	X314007
95498695	X314011
95498696	X314008
95535826	X314015
95551556	X314013
95551564	X314014
95553383	X314021

PSA (PEUGEOT/CITROËN)	
95553906	X314022
95577467	X254025
95577468	X254026
95587475	X315003
95588899	X254025
95588900	X254026
95588901	X224107
95588902	X224108
95607090	X254058
95607091	X254057
95607091	X254087
95607096	X374003
95607097	X374004
95609790	X374013
95609791	X374014
95614558	X254013
95614559	X254014
95614877	X374005
95614878	X374006
95619547	X224209
95619547	X224245
95619547	X224245
95619548	X224210
95619548	X224246
95619548	X224246
95623221	X374159
95623222	X374160
95624920	X374003
95624921	X374004
95624922	X254089
95624923	X254090
95624923	X255026
95650933	X224209
95650933	X224245
95650934	X224210
95650934	X224246
95651048	X254091
95651049	X254092
95651078	X315009
95651078	X315010
95651079	X315003
95651079	X315004
95658555	X374007
95658556	X374008
95658573	X224209
95658574	X224210
95659637	X254095
95659638	X254096
95661797	X315011
95661797	X315012
95661913	X224209
95661913	X224245
95661914	X224210
95661914	X224246
95666799	X255033
95666800	X255034
95666892	X374257
95666893	X374258
95667816	X254135
95667817	X254136
96015069	X254087
96015070	X254088
4400E5	X224248
44000000	X224248
4401E5	X284046
1308219080	X374227
1308220080	X374228
1607375480	X274039
1607375580	X274040
1607375680	X375267
1607375780	X375268

PSA (PEUGEOT/CITROËN)	
1607376880	X284045
1607376980	X284046
1607377880	X284047
1607377980	X284048
1607378080	X284029
1607378180	X284030
1607378280	X284049
1607378380	X284050
1607731680	X374663
1607731780	X374664
1607876080	X284094
1607876380	X284118
1607876380	X284118
1607876680	X284096
1607876680	X284096
1607876880	X284098
1607876880	X284098
1608998880	X277001
1608998880	X277002
1608998980	X277002
1608998980	X277002
1608999580	X277003
1608999580	X277003
1608999680	X277004
1608999680	X277004
1608999780	X224889
1608999780	X224889
1609897480	X224889
1609897580	X224890
1609897580	X224890
1610428180	X274121
1610428280	X274122
1610428280	X274122
1610762380	X225443
1610762380	X225443
1610762480	X225443
1610762480	X225443
1610900680	X225447
1610900780	X225448
1610900880	X225373
1610901080	X225374
4400E6	X254117
4400000000	X254117
4401E6	X284047
4401E6	X284047
7701202142	X255007
7701202143	X255008
7701202143	X255052
7910017114	X224107
7910017114	X224107
7910017115	X224108
7910017115	X224108
7910024045	X224145
7910024046	X224146
7910025149	X224109
7910025150	X224110
9404400648	X375017
9404400658	X375018
9404401618	X255007
9404401618	X255051
9404401628	X255008
9404401628	X255052
9404401928	X374293
9404401938	X374294
9467566980	X374661
9467567080	X374662
9566932380	X225161
9566932480	X225162
4400E7	X254118
4400000000	X254118
4401E7	X284048

PSA (PEUGEOT/CITROËN)	
4400E8	X225161
4400E8	X225161
4401E8	X284029
4401E8	X284029
4400E9	X225162
4400E9	X225162
4401E9	X284030
400A4	X225088
4400A1	X254115
4400A2	X254116
4400A3	X225087
4400A4	X225088
4400A5	X374235
4400A6	X374236
4400A9	X224227
4400C1	X224228
4400C2	X254117
4400C3	X254118
4400C4	X224209
4400C4	X224209
4400C5	X224210
4400C5	X224210
4400C8	X254131
4400C9	X254132
4400F2	X254163
4400F3	X254164
4400F4	X254087
4400F5	X254058
4400F5	X254088
4400F6	X315017
4400F6	X315018
4400F7	X254207
4400F7	X254207
4400F8	X254208
4400F8	X254208
4400F9	X224209
4400F9	X224209
4400G0	X224210
4400G0	X224210
4400G5	X225087
4400G6	X225088
4400G7	X224247
4400G8	X224248
4400G9	X225159
4400H0	X225160
4400H1	X254229
4400H2	X254230
4400H3	X254095
4400H4	X254096
4400H5	X254135
4400H6	X254136
4400H8	X225159
4400H9	X225160
4400J0	X274021

Références d'origine Etrier

O.E.M. - OE Nummern - Codigos originales - Codici originali

PSA (PEUGEOT/CITROËN)	
4400K6	X274010
4400K6	X274010
4400K7	X274011
4400K7	X274011
4400K8	X274012
4400K8	X274012
4400K9	X224209
4400K9	X224209
4400L0	X224210
4400L0	X224210
4400L1	X225087
4400L2	X225088
4400L3	X315023
4400L3	X315024
4400L4	X274015
4400L5	X274016
4400L6	X274017
4400L7	X274018
4400L8	X274019
4400L9	X274020
4400N0	X274023
4400N1	X274024
4400N2	X274039
4400N3	X274040
4400N4	X375267
4400N5	X375268
4400N6	X274005
4400N7	X274006
4400N8	X274025
4400N9	X274026
4400P0	X274027
4400P1	X274028
4400P2	X274029
4400P3	X274030
4400P4	X375347
4400P5	X375348
4400P8	X375295
4400P8	X375295
4400P9	X375296
4400P9	X375296
4400R0	X224655
4400R1	X224656
4400R2	X375295
4400R2	X375295
4400R3	X375296
4400R3	X375296
4400R4	X275025
4400R4	X275025
4400R5	X275026
4400R5	X275026
4400R6	X274023
4400R7	X274024
4400R7	X274024
4400R8	X274039
4400R9	X274040
4400T0	X275041
4400T1	X275042
4400T2	X224655
4400T3	X224656
4400T4	X224685
4400T5	X224686
4400T7	X275055
4400T8	X275056
4400T9	X164207
4400T9	X164207
4400V0	X164208
4400V0	X164208
4400V1	X165167
4400V2	X165168
4400V3	X224751
4400V4	X224752

PSA (PEUGEOT/CITROËN)	
4400V5	X225373
4400V6	X225374
4400V7	X224685
4400V8	X224686
4400W1	X224759
4400W2	X224760
4400W5	X375347
4400W5	X375347
4400W6	X375348
4400W6	X375348
4400W7	X274039
4400W7	X274039
4400W8	X274040
4400W8	X274040
4400W9	X224903
4400W9	X224903
4400X0	X224904
4400X0	X224904
4400X1	X224759
4400X2	X224760
4400X9	X225373
4400Y0	X225374
4401A0	X374379
4401A1	X374380
4401A2	X255033
4401A2	X255033
4401A3	X255034
4401A3	X255034
4401A4	X374411
4401A5	X374412
4401A6	X374403
4401A6	X374403
4401A7	X374404
4401A7	X374404
4401A8	X374405
4401A8	X374405
4401A9	X374406
4401A9	X374406
4401C0	X284015
4401C1	X284016
4401C2	X374381
4401C3	X374382
4401C4	X284199
4401C5	X284200
4401C6	X374589
4401C7	X374590
4401C8	X375291
4401C8	X375291
4401C9	X375292
4401C9	X375292
4401F0	X284049
4401F0	X284049
4401F1	X284050
4401F2	X285031
4401F2	X285031
4401F3	X285032
4401F3	X285032
4401F4	X284113
4401F5	X284114
4401F6	X284046
4401F7	X284048
4401G0	X374597
4401G1	X374598
4401G2	X374599
4401G3	X374600
4401G4	X375333
4401G5	X375334
4401G6	X284030
4401G6	X284030
4401G7	X284050
4401G8	X274087

PSA (PEUGEOT/CITROËN)	
4401G8	X274087
4401G9	X274088
4401G9	X274088
4401H0	X375353
4401H1	X375354
4401H2	X374597
4401H3	X374598
4401H4	X374599
4401H5	X374600
4401H6	X284045
4401H6	X284045
4401H7	X284046
4401H7	X284046
4401H8	X284047
4401H8	X284047
4401H9	X284048
4401J0	X284029
4401J1	X284030
4401J2	X284049
4401J3	X284050
4401J4	X375413
4401J4	X375413
4401J5	X375414
4401J5	X375414
4401J6	X284093
4401J6	X284093
4401J7	X284094
4401J7	X284094
4401J8	X284117
4401J8	X284117
4401J9	X284118
4401J9	X284118
4401K0	X284095
4401K0	X284095
4401K1	X284096
4401K1	X284096
4401K2	X284097
4401K3	X284098
4401K4	X275051
4401K4	X275051
4401K5	X275052
4401K5	X275052
4401K6	X374405
4401K7	X374406
4401K8	X374661
4401K8	X374661
4401K9	X374662
4401K9	X374662
4401L0	X375341
4401L0	X375341
4401L1	X375342
4401L1	X375342
4401L2	X374663
4401L2	X374663
4401L3	X374664
4401L3	X374664
4401L4	X285031
4401L4	X285031
4401L5	X285032
4401L6	X284045
4401L7	X284046
4401L8	X284047
4401L9	X284048
4401N0	X284029
4401N1	X284030
4401N2	X284049
4401N3	X284050
4401N4	X374699
4401N5	X374700
4401N6	X375267
4401N7	X375268
4401N8	X274091
4401N8	X274091

PSA (PEUGEOT/CITROËN)	
4401N9	X274092
4401N9	X274092
4401P4	X375359
4401P4	X375359
4401P5	X375360
4401P5	X375360
4401P6	X274071
4401P6	X274071
4401P7	X274072
4401P8	X274095
4401P9	X274096
4401Q0	X375457
4401Q1	X375458
4401Q2	X375459
4401Q3	X375460
4401Q4	X275055
4401Q5	X275056
4401Q6	X275025
4401Q6	X275025
4401Q7	X275026
4401Q7	X275026
4401Q8	X224903
4401Q8	X224903
4401Q9	X224904
4401Q9	X224904
4401R8	X225447
4401R9	X225448
4401S0	X225447
4401S1	X225448
4401S2	X374747
4401S3	X374748
4402F5	X375403
4402F6	X375404
GX2512801B	X315005
ZF00937779	X374011
ZF00937780	X374012
RENAULT	
811972	X374626
1954458	X374393
5002673	X374029
5002674	X374030
8111861	X285011
8111862	X285012
8111971	X374367
8111971	X374625
8111972	X374368
8252970	X274075
8252971	X274076
8252972	X275027
8252973	X275028
8253030	X375281
8253031	X375282
8253056	X375396
8253248	X375355
8253249	X375356
8253251	X375396
8253305	X284127
8253306	X284128
8253847	X274051
8253848	X274052
8253962	X224617
8253963	X224618
8472236	X374507
8472237	X374508
32056363	X375282
32057286	X375281
32063989	X375395
95666893	X374258
870509000	X254151
870509100	X254152
870509200	X255041

RENAULT	
870509300	X255042
5000392500	X374422
5000392501	X374421
5001001409	X374173
5001001409	X374217
5001001410	X374174
5001001410	X374218
5001848040	X284042
5001848129	X284043
5001848130	X284044
5001856069	X284041
5001856070	X284042
5001867379	X284041
5001867380	X284042
5001867383	X285029
5001867384	X285030
5001867385	X284043
5001867386	X284044
5001867455	X284041
5001867456	X284042
5001867468	X284043
5001867469	X284044
5001874362	X284041
5001874363	X284042
5001874366	X284043
5001874367	X284044
6000061024	X255012
6000061025	X255011
6001547616	X374029
6001547617	X374030
6025071053	X255049
6025071054	X255050
6025308764	X285006
6025308765	X285005
6025370396	X374368
6025370397	X374367
6025370848	X374508
6025370849	X374507
6025371277	X374453
6025371278	X374454
6025371280	X375246
6025371281	X375245
7701006628	X254031
7701006629	X254032
7701012216	X374329
7701012569	X254179
7701012569	X374329
7701012570	X254180
7701021844	X224125
7701021845	X224126
7701023660	X374261
7701023661	X374262
7701049091	X224617
7701049092	X224618
7701049103	X224591
7701049104	X224592
7701049108	X225245
7701049109	X225246
7701049762	X224563
7701049763	X224564
7701050915	X375197
7701050916	X375198
7701050919	X374453
7701050920	X374454
7701051808	X374454
7701056165	X375260
7701056166	X375259
7701058533	X284128
7701058534	X284127
7701065266	X224647
7701065267	X224648
7701065278	X224711

RENAULT	
7701065279	X224712
7701200006	X254002
7701200007	X254001
7701200244	X254193
7701200249	X254194
7701200575	X254063
7701200576	X254064
7701200588	X255015
7701200595	X255016
7701200796	X254037
7701200797	X254038
7701201090	X254075
7701201091	X254076
7701201108	X254071
7701201108	X254083
7701201109	X254072
7701201109	X254084
7701201140	X255009
7701201141	X255010
7701201149	X254074
7701201152	X254073
7701201168	X374107
7701201169	X374108
7701201239	X254031
7701201240	X254032
7701201465	X254171
7701201469	X254172
7701201657	X254157
7701201658	X254158
7701201664	X374009
7701201665	X374010
7701201769	X374029
7701201770	X374030
7701201777	X254001
7701201778	X254002
7701201877	X255015
7701201878	X255016
7701201904	X374025
7701201905	X374026
7701201965	X374007
7701201966	X374008
7701202013	X254003
7701202013	X254157
7701202014	X254004
7701202014	X254158
7701202038	X254039
7701202039	X254040
7701202042	X254009
7701202043	X254010
7701202046	X374047
7701202047	X374048
7701202142	X255051
7701202143	X255052
7701202206	X254015
7701202207	X254016
7701202242	X374027
7701202242	X374029
7701202243	X374028
7701202	

Références d'origine Etrier

O.E.M. - OE Nummern - Codigos originales - Codici originali

RENAULT	
7701203124	X285002
7701203125	X285002
7701203659	X374367
7701203660	X374368
7701203661	X374369
7701203662	X374370
7701203664	X255055
7701203665	X255056
7701203724	X285003
7701203725	X285004
7701203844	X254147
7701203845	X254148
7701203975	X374365
7701203976	X374366
7701204221	X285005
7701204222	X285006
7701204846	X255051
7701204847	X255052
7701205493	X285011
7701205494	X285012
7701205625	X274003
7701205626	X274004
7701205763	X274049
7701205764	X274050
7701205832	X374625
7701205833	X374626
7701206000	X274003
7701206001	X274004
7701206344	X375217
7701206345	X375218
7701206513	X375385
7701206514	X375386
7701206725	X274051
7701206726	X274052
7701206754	X275023
7701206755	X275024
7701207150	X274075
7701207153	X274076
7701207477	X275027
7701207478	X275028
7701207679	X274055
7701207680	X274056
7701207685	X274053
7701207686	X274054
7701207693	X375281
7701207694	X375282
7701207786	X274003
7701207787	X274004
7701207958	X374007
7701207959	X374008
7701208012	X274065
7701208013	X274066
7701208036	X275023
7701208037	X275024
7701208127	X375281
7701208128	X375282
7701208171	X374029
7701208172	X374030
7701208256	X375445
7701208257	X375446
7701208261	X375355
7701208262	X375356
7701208263	X375395
7701208264	X375396
7701208332	X374631
7701208333	X374632
7701208361	X375343
7701208362	X375344
7701208588	X274055
7701208589	X274056
7701209055	X375395
7701209056	X375396

RENAULT	
7701209723	X375355
7701209724	X375356
7701209862	X374667
7701209863	X374668
7701209867	X375439
7701209868	X375440
7701499274	X374029
7701499275	X374030
7701499278	X254119
7701499279	X254120
7701499280	X254157
7701499281	X254158
7701499282	X254015
7701499283	X254016
7701499284	X374029
7701499285	X374030
7701499301	X374007
7701499302	X374008
7701499307	X374009
7701499308	X374010
7701499319	X374173
7701499320	X374174
7702163322	X254119
7702163323	X254120
7702295393	X374007
7702295396	X374008
7711134465	X285011
7711134466	X285012
7711134470	X254039
7711134471	X374369
7711134472	X374370
7711134473	X254040
7711135669	X375197
7711135697	X224563
7711135698	X224564
7711135699	X375197
7711135700	X375198
7711135701	X374453
7711135703	X375260
7711135704	X375259
7711135717	X374625
7711135718	X374626
7711135719	X375217
7711135720	X375218
7711135721	X375385
7711135722	X375386
7711135734	X274053
7711135735	X274054
7711135736	X375281
7711135737	X375282
410010001R	X224822
410010823R	X374668
410015070R	X284172
410015708R	X284172
410016069R	X224878
410017733R	X374668
410018218R	X224818
410019795R	X224648
41001JY00A	X554058
410110001R	X224821
410110092R	X284171
410111495R	X224817
410111997R	X284171
410115265R	X374667
410115900R	X224647
410118579R	X224877
410119144R	X374667
41011JY00A	X554057
440010014R	X225428
440010724R	X285082
440010814R	X285070
440011499R	X375356

RENAULT	
440011818R	X375440
440011819R	X285082
440011959R	X377056
440011KD0A	X165176
440013546R	X377010
440014373R	X285070
440015452R	X375440
440018805R	X375282
440019012R	X377012
44001JY00A	X165192
440110006R	X225427
440110675R	X377011
440110830R	X375355
440111516R	X285069
440111KD0A	X165175
440114926R	X375439
440115651R	X285081
440116884R	X285081
440118013R	X377009
440118627R	X375439
440118711R	X285069
440119106R	X377055
440119651R	X375281
44011JY00A	X165191
RENAULT TRUCKS	
5001867383	X285045
5001867384	X285046
ROVER	
34111512777	X224581
34111512778	X224582
34116768457	X224581
34116768458	X224582
34216757247	X225273
34216757248	X225274
45012SN7G41	X374374
45013SN7G41	X374373
45018SM5000	X374372
45018SS0A00	X374372
45019SM5000	X374371
45019SS0A00	X374371
45210SM5G51	X374372
45210SS0G01	X374372
45230SM5G51	X374371
45230SS0G01	X374371
AAU2744	X464034
AAU2745	X464033
BAU5125	X464031
BAU5126	X464032
BAU5618	X374202
BAU5619	X374201
CAP5060	X464031
CAP5061	X464032
CDU2934	X375054
CDU2935	X375053
EJP1423	X375081
EJP1424	X375082
EJP1439	X374167
EJP1440	X374168
GBC117	X674002
GBC118	X674001
GBC119	X674020
GBC120	X674019
GBC128	X375054
GBC135	X374201
GBC137	X374202
GBC145	X375053
GBC154	X374168
GBC155	X374216
GBC156	X374167
GBC157	X374215
GBC158	X375081
GBC161	X375082

ROVER	
GBC163	X374285
GBC164	X374286
GBC165	X374202
GBC165	X374238
GBC166	X374201
GBC166	X374237
GBC169	X374288
GBC170	X374287
GBC90172	X374373
GBC90173	X374374
GBC90174	X374371
GBC90174	X374373
GBC90175	X374372
GBC90175	X374374
GBC90178	X375095
GBC90178	X585021
GBC90179	X375096
GBC90179	X585022
GBC90189	X374447
GBC90190	X374448
GBC90194	X225108
GBC90194	X225254
GBC90196	X225107
GBC90196	X225253
GBC90198	X224548
GBC90200	X224547
SEG000040	X224556
SEG000050	X224555
SEG000080	X374168
SEG000090	X374167
SEG100170	X374448
SEG100180	X374447
SEG100210	X224547
SEG100240	X224548
SMC000460	X375232
SMC000470	X375231
SOB000040	X225210
SOB000050	X225209
STC1282	X464100
STC1283	X464099
SAAB	
542092	X225278
542093	X225277
891975	X224009
891976	X224010
4243218	X225025
4543785	X224051
4543773	X224052
4566873	X225187
4566881	X225188
4611539	X225163
4611554	X224521
4611562	X224522
4612701	X225187
4612719	X225188
4836946	X225188
4836953	X225187
4838967	X224429
4838967	X224521
4838975	X224430
4838975	X224522
4838983	X225163
5055413	X224521
5055421	X224522
5058136	X225269
5058144	X225270
5084702	X224430
5084710	X224429
5391834	X225357
5391842	X225358
7352495	X464009
7352503	X464010

SAAB	
7871676	X224009
7871684	X224010
7871718	X225005
7871726	X225006
7873649	X464009
7873656	X464010
7874720	X374075
7874738	X374076
7894967	X374413
7894975	X374414
7894983	X374031
7894991	X374032
7895006	X225011
7895014	X225012
7895022	X374069
7895030	X374070
7895113	X225029
7895121	X225030
7895170	X374075
7895188	X374076
7895196	X374075
7895204	X374076
7895287	X374069
7895295	X374070
7895303	X224051
7895311	X224052
7895329	X225011
7895337	X225012
7895337	X225080
7895378	X374075
7895386	X374076
8828956	X225025
8828980	X224051
8828998	X224052
8907875	X225005
8907875	X225029
8907883	X225006
8907883	X225030
8930935	X374075
8930943	X374076
8932196	X225029
8939589	X374075
8939597	X374076
8955908	X374031
8955916	X374032
8961823	X225011
8961831	X225012
8967770	X374069
8967788	X374070
8968927	X224051
8968934	X224052
8968935	X224052
8968943	X224051
8968950	X224052
8969990	X225011
8970006	X225080
8970618	X225011
8970626	X225012
8970626	X225080
8985277	X225029
8985285	X225030
8985871	X374075
8985889	X374076
9102765	X225029
9102773	X225030
9102807	X374075
9102815	X374076
9102971	X374069
9102989	X374070
9103458	X374413
9103466	X374414
12800330	X224635

SAAB	
12800331	X224636
12800332	X224703
12800333	X224704
12800336	X225403
12800337	X225404
12802160	X224707
12802161	X224708
13273621	X284146
13273623	X284145
13343569	X375431
13343570	X375432
93172182	X225277
93172183	X225278
93185745	X224625
93185746	X224626
7895410X	X374069
7895428X	X374070
PHCB253	X374075
PHCB254	X374076
SEAT	
191615123	X224493
191615124	X224494
191615424	X375032
441615107	X224467
443615123	X374037
893615123	X374037
191615424B	X375032
1A8615123	X374192
1H0615423D	X375123
1H0615424D	X375124
1J0615423A	X375191
1J0615423B	X375193
1J0615423C	X375313
1J0615423D	X375275
1J0615423E	X375255
1J0615423F	X375275
1J0615424A	X375192
1J0615424B	X375194
1J0615424C	X375314
1J0615424D	X375276
1J0615424E	X375256
1K0615123G	X224725
1K0615123J	X224725
1K0615123M	X224619
1K0615123N	X224741
1K0615124G	X224726
1K0615124J	X224726

Références d'origine Etrier

O.E.M. - OE Nummern - Codigos originales - Codici originali

SEAT	
4D0615107A	X374407
4D0615107B	X374651
4D0615108A	X374408
4D0615108B	X374652
4G0615123A	X374735
4G0615123B	X224857
4G0615123C	X374733
4G0615123D	X374735
4G0615124A	X374736
4G0615124B	X224858
4G0615124C	X374734
4G0615124D	X374736
4G0615403	X377043
4G0615403B	X377049
4G0615403C	X377047
4G0615404	X377044
4G0615404B	X377050
4G0615404C	X377048
6K0615423	X375123
6K0615424	X375124
6N0615123B	X254213
6N0615124B	X254214
6N0615423A	X375253
6N0615423B	X375253
6N0615424A	X375254
6N0615424B	X375254
6Q0615123	X374615
6Q0615123A	X374615
6Q0615124A	X374616
6Q0615423B	X375299
6Q0615424B	X375300
6R0615423A	X375275
6R0615424A	X375276
6X0615123	X254241
6X0615124	X254242
701615124DX	X374392
7H0615123B	X224721
7H0615124B	X224722
7L6615123M	X284107
7L6615123N	X284089
7L6615123Q	X284089
7L6615123R	X284123
7L6615123S	X284161
7L6615123T	X284107
7L6615124M	X284108
7L6615124N	X284090
7L6615124Q	X284090
7L6615124R	X284124
7L6615124S	X284162
7L6615124T	X284108
7L6615149	X284089
7L6615150	X284090
7L6615423H	X285063
7L6615423K	X285073
7L6615423L	X285063
7L6615424H	X285064
7L6615424K	X285074
7L6615424L	X285064
7L8615423	X285095
7L8615423A	X285095
7L8615424	X285096
7L8615424A	X285096
7L9615123	X284161
7L9615124	X284162
7L9615403B	X285073
7L9615404B	X285074
7L9615423	X285073
7L9615424	X285074
7M0615123B	X224449
7M0615123C	X224449
7M0615124B	X224450
7M0615124C	X224450

SEAT	
7M0615423	X375123
7M0615424	X375124
7M0615123A	X224449
8J0615423B	X375379
8J0615423C	X375377
8J0615423E	X375379
8J0615423F	X375377
8J0615424B	X375380
8J0615424C	X375378
8J0615424E	X375380
8J0615424F	X375378
8K0615123	X374675
8K0615123B	X374675
8K0615123D	X374735
8K0615123E	X374735
8K0615123J	X374735
8K0615124	X374676
8K0615124B	X374676
8K0615124D	X374736
8K0615124E	X374736
8K0615124J	X374736
8L0615123	X224249
8L0615124	X224250
8V0615123A	X374759
8V0615123D	X374759
8V0615124A	X374760
8V0615124D	X374760
SE021165005A	X254149
SE021165006A	X254150
SE022165005A	X254086
SE022165005B	X374357
SE022165005C	X254086
SE022165006A	X254085
SE022165006B	X374358
SE022165006C	X254085
SE141165005C	X254086
SE141165006C	X254085
SKODA	
4532247	X374203
4532248	X374204
113430200	X344001
113430201	X344003
113430202	X344002
113430201	X344004
114430202	X374203
114430203	X374204
115430202	X374203
115430203	X374204
115430202	X374204
115430202	X374203
115430205	X374203
115430251	X374204
115430980	X374203
115430981	X374204
441615107	X224467
443611200003	X344004
443611200006	X604002
443611207003	X344003
443611207006	X604001
1A8615123	X374192
1H0615423D	X375123
1H0615424D	X375124
1J0615423C	X375313
1J0615423E	X375255
1J0615423F	X375275
1J0615424C	X375314
1J0615424E	X375256
1K0615123A	X224455
1K0615123E	X224619
1K0615123G	X224725
1K0615123J	X224725
1K0615123M	X224619
1K0615124E	X224620
1K0615124G	X224726

SKODA	
1K0615124J	X224726
1K0615124M	X224620
1K0615423G	X375379
1K0615423K	X375379
1K0615423L	X375377
1K0615423N	X375377
1K0615423P	X375377
1K0615424G	X375380
1K0615424J	X375294
1K0615424K	X375380
1K0615424L	X375378
1K0615424N	X375378
1K0615424P	X375378
1U0615123	X224249
1U0615124	X224250
1Z0615123	X224619
1Z0615124	X224620
1Z0615423	X375313
1Z0615424	X375314
2E0615423A	X275039
2E0615424A	X275040
2H0615123	X274111
2H0615124	X274112
443615107C	X224181
443615108C	X224182
443615123E	X224181
443615124E	X224182
4A0615107	X374385
4A0615107A	X374765
4A0615108A	X374766
4B0615107	X374757
4B0615108	X374758
4D0615107A	X374407
4D0615107B	X374651
4D0615108A	X374408
4D0615108B	X374652
4G0615123A	X374735
4G0615123B	X224857
4G0615123C	X374733
4G0615123D	X374735
4G0615124A	X374736
4G0615124B	X224858
4G0615124C	X374734
4G0615124D	X374736
4G0615403	X377043
4G0615403B	X377049
4G0615403C	X377047
4G0615404	X377044
4G0615404B	X377050
4G0615404C	X377048
5G0615123	X374759
5G0615123C	X374759
5G0615124	X374760
5G0615124C	X374760
6Q0615123A	X374615
6Q0615124A	X374616
6Q0615423B	X375299
6Q0615424B	X375300
6R0615423A	X375275
6R0615424A	X375276
6U0615123	X374203
6U0615124	X374204
701615124DX	X374392
7H0615123B	X224721
7H0615124B	X224722
7L6615123M	X284107
7L6615123N	X284089
7L6615123Q	X284089
7L6615123R	X284123
7L6615123S	X284161
7L6615123T	X284107
7L6615124M	X284108

SKODA	
7L6615124N	X284090
7L6615124Q	X284090
7L6615124R	X284124
7L6615124S	X284162
7L6615124T	X284108
7L6615149	X284089
7L6615150	X284090
7L6615423H	X285063
7L6615423K	X285073
7L6615423L	X285063
7L6615424H	X285064
7L6615424K	X285074
7L6615424L	X285064
7L8615423	X285095
7L8615423A	X285095
7L8615424	X285096
7L8615424A	X285096
7L9615123	X284161
7L9615124	X284162
7L9615403B	X285073
7L9615404B	X285074
7L9615423	X285073
7L9615424	X285074
7M0615123B	X224449
7M0615124C	X224450
8J0615423B	X375379
8J0615423C	X375377
8J0615423E	X375379
8J0615423F	X375377
8J0615424B	X375380
8J0615424C	X375378
8J0615424E	X375380
8J0615424F	X375378
8K0615123	X374675
8K0615123B	X374675
8K0615123D	X374735
8K0615123E	X374735
8K0615123J	X374735
8K0615124	X374676
8K0615124B	X374676
8K0615124D	X374736
8K0615124E	X374736
8K0615124J	X374736
8L0615123	X224249
8L0615124	X224250
8V0615123A	X374759
8V0615124A	X374760
SMART	
4514210098	X274102
4514210198	X274101
4544200501	X374681
4544200601	X374682
4544200701	X375369
4544200801	X375370
4544210106	X374419
4544210206	X374420
4334V002	X274073
4334V00200000	X274073
4335V002	X274074
4335V00200000	X274074
Q0004334V	X274073
Q0004334V0020	X274073
Q0004335V	X274074
Q0004335V0020	X274074
Q0004335V0020	X274074
SSANGYONG	
4811008260	X484033
4814008260	X484034
4841008001	X485017
4844008001	X485018
SUBARU	
625022083	X164160

SUBARU	
625022085	X164160
625022093	X164159
625022095	X164159
725110410	X674066
725110420	X674065
725110521	X674012
725110531	X674011
725110860	X674012
725110870	X674011
725110901	X674012
725110901	X674048
725110911	X674011
725110911	X674047
725163020	X164164
725163022	X164164
725163030	X164163
725163032	X164163
725163140	X164166
725163141	X164166
725163150	X164165
725163151	X164165
725163180	X164110
725163181	X164168
725163190	X164109
725163191	X164167
6222500080	X165102
4771097209	X674100
4772097209	X674099
4771087204000	X644040
4772087204000	X644039
5510180E10	X274038
25110GA180	X675010
25110GA181	X675010
25110GA182	X675010
25110GA190	X675009
25110GA191	X675009
25110GA192	X675009
25110GA370	X675018
25110GA371	X675018
25110GA372	X675018
25110GA380	X675017
25110GA381	X675017
25110GA382	X675017
25191GA600	X164110
25191GA610	X164109
26200KA080	X584020
26200KA090	X584019
26220AA001	X164134
26220AA011	X164133
26220AA061	X165060
26220AA062	X165060
26220AA071	X165059
26220AA072	X165059
26220AA081	X165102
26220AA082	X165102
26220AA091	X165101
26220AA092	X165101
26220AA100	X164251
26220AA101	X164252
26220AA110	X164252
26220AA111	X164251
26220AA121	X165126
26220AA122	X165126
26220AA131	X165125
26220AA141	X674064
26220AA151	X674063
26220AA160	X164134
26220AA170	X164133
26220AA180	X674064
26220AA190	X674063
26225AA080	X165102

SUBARU	
62255AA090	X165101
62291AA000	X674064
62291AA001	X674064
62291AA010	X674063
62291AA011	X674063
62291AA021	X164134
62291AA031	X164133
62291AA040	X164252
62291AA041	X164252
62291AA050	X164251
62291AA051	X164251
62291AA060	X165060
62291AA070	X165059
62291AA080	X165102
62291AA090	X165101
62291AA100	X165102
62291AA110	X165101
62291AC000	X164278
62291AC001	X164278
62291AC002	X164278
62291AC010	X164277
62291AC011	X164277
62291AC012	X164277
62291AC020	X164266
62291AC021	X164266
62291AC022	X164266
62291AC030	X164265
62291AC031	X164265

Références d'origine Etrier

O.E.M. - OE Nummern - Codigos originales - Codici originali

SUBARU		SUZUKI		SUZUKI		TALBOT		TOYOTA		TOYOTA	
26692AG030	X675041	5510161G52	X134046	55102B60A00	X674069	75061445	X374323	4773010101	X704036	4773020200	X164008
26692AG041	X675042	5510161G54	X134044	55102M68K00	X554063	75061446	X374324	4773012020	X164016	4773020201	X164008
26692AG051	X675041	5510161G55	X134046	55102M72F10	X374463	177558500	X254079	4773012021	X164016	4773020230	X165004
26692FA041	X165150	5510161G55999	X134046	5510367D00	X114002	7910017114	X224107	4773012030	X164157	4773020240	X704032
26692FA051	X165149	5510161G61	X134044	55103M79F00	X674072	7910017115	X224108	4773012030	X164170	4773020250	X135004
26692FA060	X165150	5510161G62	X134044	5510467D00	X114001	7910028608	X254083	4773012050	X164172	4773020260	X135004
26692FA070	X165149	5510164B10	X674060	55104M79F00	X674071	7910028609	X254084	4773012060	X164172	4773020270	X164066
26692FC000	X165162	5510164B21	X674060	5511062J00	X374672	45288G	X255046	4773012060	X164189	4773020290	X704014
26692FC001	X165162	5510164B30	X674060	5511062J10	X374672	45313Y	X255045	4773012070	X644022	4773020300	X704016
26692FC010	X165161	5510164G00	X674076	5511079J00	X374716	49710N	X254066	4773012080	X644022	4773020370	X704014
26692FC011	X165161	5510164G01	X674076	5511079J10	X374716	49735B	X254065	4773012110	X644034	4773020410	X704032
26692FG000	X675050	5510164G02	X674076	5512062J00	X374671	TOYOTA		4773012111	X644034	4773020420	X165004
26692FG010	X675049	5510165D00	X674068	5512062J10	X374671	4771012110	X644022	4773012140	X644034	4773020430	X135004
26692FJ000	X675048	5510165D01999	X674068	5512079J00	X374715	4771012130	X644022	4773012141	X644034	4773020440	X704032
26692FJ010	X675047	5510165D10	X644142	5512079J10	X374715	4771012140	X644022	4773012170	X704022	4773020460	X704014
47710B1050	X674100	5510165D10999	X644142	5540160J00	X675038	4771022013	X644016	4773012171	X704022	4773020470	X704014
47710B1113	X674100	5510165D20999	X644142	5540160J00999	X675038	4771022021	X644016	4773012180	X164186	4773020470	X704016
47720B1050	X674099	5510165D21999	X644142	5540162G01	X525020	4771022040	X644016	4773012210	X704008	4773020480	X384002
47720B1113	X674099	5510165J00999	X114002	5540162G0V999	X525020	4771022040	X644082	4773012230	X165074	4773020490	X384004
47730B1051	X674100	5510165J04	X114002	5540164B00	X675030	4771022041	X644016	4773012231	X165074	4773020510	X134068
47730B2032	X674100	5510165J04999	X114002	5540168L00	X675052	4771022041	X644082	4773012250	X164010	4773020520	X134028
47750B1051	X674099	5510168L00	X554064	5540168L00999	X675052	4771022060	X644082	4773012280	X165072	4773020530	X134038
47750B2032	X674099	5510168L00999	X554064	5540168L01	X675052	4771022061	X644082	4773012290	X704012	4773020540	X165100
SUZUKI		5510175F10	X134050	5540168L01999	X675052	4772012110	X644021	4773012310	X704022	4773020560	X644114
5510177E00	X644142	5510177E00999	X644142	5540180J00	X585044	4772012130	X644021	4773012320	X704022	4773020570	X645012
5510183E00	X274058	5510180G00	X674072	5540180J00999	X585044	4772012140	X644021	4773012330	X165016	4773020600	X134068
5510183	X274058	5510180G01	X674072	5540260J00	X675037	4772022013	X644015	4773012350	X704022	4773020610	X134066
5510277E00	X644141	5510180J01999	X674096	5540260J00999	X675037	4772022021	X644015	4773012380	X165016	4773020630	X645028
5510283E00	X274057	5510181A10	X134058	5540262G01	X525019	4772022040	X644015	4773012400	X704024	4773020640	X134066
5510283	X274057	55101B60A00	X674070	5540262G0V999	X525019	4772022040	X644081	4773012410	X704022	4773021010	X134038
5510384	X274060	55101M68K00	X554064	5540264B00	X675029	4772022041	X644015	4773012420	X134022	4773021030	X135024
5510484	X274059	55101M72F10	X374464	5540268L00	X675051	4772022041	X644081	4773012430	X165016	4773022110	X644138
5510080010	X134011	5510250J00999	X114013	5540268L00999	X675051	4772022060	X644081	4773012450	X704026	4773024082	X164246
5510080010	X134012	5510250J01999	X114013	5540268L01	X675051	4772022601	X644081	4773012451	X704026	4773025010	X134016
5510178450	X674038	5510254G11	X584047	5540268L01999	X675051	4773002060	X374578	4773012460	X165016	4773025011	X134016
5510178451	X674038	5510254G50	X584047	5540280J00	X585043	4773002090	X375238	4773012470	X165156	4773025020	X134018
5510178461	X674038	5510256B00	X674067	5540280J00999	X585043	4773002100	X374592	4773012470	X165156	4773025020	X134018
5510182021	X134002	5510260A00	X674069	5818002A10	X484045	4773002101	X374592	4773013020	X645030	4773026010	X194018
5510278450	X674037	5510260A01	X674069	5818102A10	X484046	4773002110	X375394	4773013030	X134066	4773026030	X194012
5510278451	X674037	5510260A02	X674069	BNP7156	X674038	4773002111	X375394	4773013050	X134066	4773026040	X194006
5510278461	X674037	5510260A30	X674069	BNP7157	X674037	4773002190	X374592	4773014030	X164162	4773026060	X134008
5510282021	X134001	5510260B00	X674061	TALBOT		4773002340	X274094	4773014040	X164042	4773026070	X134010
5510282022	X134001	5510260B51	X134003	2768200	X224310	4773002341	X274094	4773014040	X164172	4773026080	X194006
5510180E10	X274038	5510260B80	X674061	2770700	X224309	4773002360	X274104	4773014041	X164042	4773026100	X134010
5510280E10	X274037	5510261G52	X134045	12866200	X224314	4773002361	X274104	4773014041	X164172	4773026120	X134030
5510070A00	X134011	5510261G54	X134043	12866300	X224313	4773002510	X274124	4773014130	X165050	4773026121	X134030
5510070A00	X134012	5510261G55	X134045	13503000	X374328	4773005010	X384004	4773014140	X164014	4773026122	X134030
5510070A01	X134011	5510261G55999	X134045	13503100	X374327	4773005020	X384004	4773014150	X164014	4773026130	X134032
5510070A01	X134012	5510261G61	X134043	13511000	X255045	4773005030	X224654	4773014150	X165050	4773026132	X134032
5510070A02	X134011	5510261G62	X134043	13511000	X255046	4773005040	X375366	4773014190	X165020	4773026190	X164188
5510070A02	X134012	5510264B10	X674059	13573900	X254066	4773005050	X274070	4773014200	X164070	4773027030	X164062
5510070A03	X134011	5510264B21	X674059	13574000	X254065	4773005050	X274070	4773014220	X164070	4773027070	X164062
5510070A03	X134012	5510264B30	X674059	13673900	X374098	4773005060	X274070	4773014230	X165020	4773027070	X164068
5510081A10	X134057	5510264G00	X674075	13675000	X374097	4773005070	X275036	4773014250	X164246	4773028011	X164062
5510081A11	X134057	5510264G01	X674075	17482400	X224130	4773005071	X275036	4773014260	X644122	4773028012	X164062
5510081A11	X134058	5510264G02	X674075	17482900	X224129	4773005110	X274118	4773014270	X645008	4773028030	X164062
5510081A11999	X134057	5510265D00	X674067	17558400	X254080	4773006010	X384004	4773016010	X674004	4773028070	X164250
5510081A12	X134057	5510265D01999	X674067	17558500	X254079	4773006020	X134028	4773016040	X704020	4773028080	X164072
5510081A12	X134058	5510265D10	X644141	30502600	X604001	4773006040	X164284	4773016090	X704038	4773028150	X164274
5510081A12999	X134057	5510265D10999	X644141	30855700	X604002	4773007020	X164212	4773017010	X165062	4773028160	X164222
5510150J00999	X114014	5510265D20999	X644141	32741000	X255002	4773009010	X224472	4773017020	X165062	4773028170	X164274
5510150J01999	X114014	5510265D21999	X644141	32741100	X255001	4773009011	X224472	4773017050	X165062	4773028190	X705002
5510154G11	X584048	5510265J00999	X114001	43200100	X224179	4773009020	X274042	4773017090	X134024	4773028200	X164222
5510154G50	X584048	5510265J04	X114001	43200200	X224180	4773009030	X224654	4773017100	X165096	4773028220	X164232
5510156B00	X674068	5510265J04999	X114001	43248400	X254082	4773010010	X164172	4773017120	X165172	4773028230	X164248
5510160A00	X674070	5510268L00	X554063	43248500	X254081	4773010011	X704042	4773017120	X165174	4773028260	X164276
5510160A01	X674070	5510268L00999	X554063	43255300	X254017	4773010030	X704042	4773017130	X165098	4773028270	X705006
5510160A02	X674070	5510275F10	X134049	43255400	X254018	4773010060	X704006	4773017140	X134026	4773028570	X704044
5510160A30	X674070	5510277E00999	X644141	43257500	X374045	4773010061	X704006	4773017150	X134064	4773030230	X134036
5510160B30	X674062	5510280G00	X674071	43257600	X374046	4773010070	X704010	4773017160	X165174	4773030231	X134036
5510160B51	X134004	5510280G01	X674071	55734200	X224374	4773010071	X704010	4773020060	X644016	4773030233	X134036
5510160B80	X674062	5510280J01999	X674095	55734300	X224373	4773010090	X704034	4773020130	X644016	4773030270	X135016
						4773010100	X704036	4773020160	X704002	4773030380	X135010

Références d'origine Etrier

O.E.M. - OE Nummern - Codigos originales - Codici originali

TOYOTA	
4773030400	X134036
4773030500	X134036
4773032022	X704024
4773032050	X135002
4773032070	X704016
4773032140	X135004
4773032150	X135004
4773033010	X135004
4773033020	X135006
4773033030	X384004
4773033040	X134028
4773033050	X135004
4773033051	X135004
4773033060	X135006
4773033061	X135006
4773033070	X384004
4773033080	X164212
4773033090	X135008
4773033100	X135004
4773033110	X384004
4773033111	X384004
4773033120	X164284
4773033140	X135006
4773033160	X135022
4773033190	X134076
4773033200	X134076
4773034030	X645032
4773035010	X644054
4773035080	X644054
4773035080	X644056
4773035090	X644124
4773035120	X644156
4773035130	X194006
4773035140	X644056
4773035170	X645050
4773036022	X134020
4773042010	X644116
4773042040	X644144
4773042050	X645018
4773042090	X114010
4773042091	X114010
4773044010	X134060
4773044020	X164280
4773044021	X164280
4773047020	X114006
4773047050	X114006
4773047060	X644188
4773048030	X164310
4773048040	X135030
4773050030	X134040
4773050040	X135012
4773050060	X134034
4773050061	X134034
4773050080	X135014
4773050110	X135018
4773050111	X135018
4773052010	X134052
4773052020	X134054
4773052030	X645026
4773052031	X645026
4773052040	X645024
4773052040	X645036
4773052041	X645036
4773052191	X134070
4773052211	X134072
4773060021	X644058
4773060030	X644126
4773060040	X645010
4773060060	X644128
4773060070	X645010
4773060090	X644154
4773060100	X645016

TOYOTA	
4773060101	X645016
4773060110	X645010
4773060130	X644164
4773060261	X644164
4773060280	X644206
4773060300	X644220
4773074010	X644200
4775002060	X374577
4775002080	X375237
4775002100	X374591
4775002101	X374591
4775002110	X375393
4775002111	X375393
4775002190	X374591
4775002250	X274123
4775002340	X274093
4775002341	X274093
4775002360	X274103
4775002361	X274103
4775005010	X384003
4775005020	X384003
4775005030	X224653
4775005040	X375365
4775005050	X274069
4775005060	X274069
4775005070	X275035
4775005071	X275035
4775005110	X274117
4775006010	X384003
4775006020	X134027
4775006040	X164283
4775007020	X164211
4775009010	X224471
4775009011	X224471
4775009020	X274041
4775009030	X224653
4775010010	X164189
4775010011	X704041
4775010030	X704041
4775010060	X704005
4775010061	X704005
4775010070	X704009
4775010071	X704009
4775010090	X704033
4775010100	X704035
4775010101	X704035
4775012020	X164015
4775012021	X164015
4775012030	X164157
4775012030	X164170
4775012050	X164189
4775012060	X164172
4775012060	X164189
4775012070	X644021
4775012080	X644021
4775012110	X644033
4775012111	X644033
4775012140	X644033
4775012141	X644033
4775012170	X704021
4775012171	X704021
4775012180	X164185
4775012210	X704007
4775012230	X165073
4775012231	X165073
4775012250	X164009
4775012280	X165071
4775012290	X704011
4775012310	X704021
4775012320	X704021
4775012330	X165015
4775012350	X704021

TOYOTA	
4775012380	X165015
4775012400	X704023
4775012410	X704021
4775012420	X134021
4775012430	X165015
4775012450	X704025
4775012451	X704025
4775012460	X165015
4775012470	X165155
4775013020	X645029
4775013030	X134065
4775013050	X134065
4775014030	X164161
4775014040	X164041
4775014040	X164189
4775014041	X164041
4775014041	X164189
4775014140	X165049
4775014150	X164013
4775014160	X165049
4775014210	X165019
4775014220	X164069
4775014230	X164069
4775014240	X165019
4775014260	X164245
4775014270	X644121
4775014280	X645007
4775016010	X674003
4775016040	X704019
4775016090	X704037
4775017010	X165061
4775017020	X165061
4775017050	X165061
4775017090	X134023
4775017100	X165095
4775017120	X165171
4775017120	X165173
4775017130	X165097
4775017140	X134025
4775017150	X134063
4775017160	X165173
4775020050	X644015
4775020120	X644015
4775020150	X704001
4775020190	X164007
4775020191	X164007
4775020220	X165003
4775020230	X704031
4775020250	X135003
4775020260	X135003
4775020270	X164065
4775020290	X704013
4775020300	X704015
4775020370	X704013
4775020410	X704031
4775020420	X165003
4775020430	X135003
4775020440	X704031
4775020460	X704013
4775020470	X704013
4775020470	X704015
4775020480	X384001
4775020490	X384003
4775020510	X134067
4775020520	X134027
4775020530	X134037
4775020540	X165099
4775020560	X644113
4775020570	X645011
4775020600	X134065
4775020620	X645027
4775020640	X134065

TOYOTA	
4775021010	X134037
4775021030	X135023
4775022110	X644137
4775024082	X164245
4775025010	X134015
4775025011	X134015
4775025020	X134017
4775026010	X194017
4775026030	X194011
4775026040	X194005
4775026060	X134007
4775026070	X134009
4775026080	X194005
4775026100	X134009
4775026120	X134029
4775026121	X134029
4775026122	X134029
4775026130	X134031
4775026132	X134031
4775027011	X164187
4775027030	X164061
4775027070	X164061
4775027070	X164067
4775028011	X164061
4775028012	X164061
4775028030	X164061
4775028070	X164249
4775028080	X164071
4775028150	X164273
4775028160	X164221
4775028170	X164273
4775028190	X705001
4775028200	X164221
4775028220	X164231
4775028230	X164247
4775028260	X164275
4775028270	X705005
4775028570	X704043
4775030230	X134035
4775030231	X134035
4775030233	X134035
4775030270	X135015
4775030380	X135009
4775030400	X134035
4775030500	X134035
4775032022	X704023
4775032050	X135001
4775032070	X704015
4775032150	X135003
4775033010	X135003
4775033020	X135005
4775033030	X384003
4775033040	X134027
4775033050	X135003
4775033051	X135003
4775033060	X135005
4775033061	X135005
4775033070	X384003
4775033080	X164211
4775033090	X135007
4775033100	X135003
4775033110	X384003
4775033111	X384003
4775033120	X164283
4775033140	X135005
4775033160	X135021
4775033181	X164283
4775033190	X134075
4775033200	X134075
4775034030	X645031
4775035010	X644053
4775035080	X644055

TOYOTA	
4775035090	X644123
4775035120	X644155
4775035130	X194005
4775035140	X644055
4775035170	X645049
4775036022	X134019
4775042010	X644115
4775042040	X644143
4775042050	X645017
4775042090	X114009
4775042091	X114009
4775044010	X134059
4775044020	X164279
4775044021	X164279
4775047020	X114005
4775047050	X114005
4775047060	X644187
4775048030	X164309
4775048040	X135029
4775050030	X134039
4775050040	X135011
4775050060	X134033
4775050061	X134033
4775050080	X135013
4775050110	X135017
4775050111	X135017
4775052010	X134051
4775052020	X134053
4775052030	X645025
4775052031	X645025
4775052040	X645023
4775052040	X645035
4775052041	X645035
4775052191	X134069
4775052211	X134071
4775060021	X644057
4775060030	X644125
4775060040	X645009
4775060060	X644127
4775060070	X645009
4775060090	X644153
4775060100	X645015
4775060101	X645015
4775060110	X645009
4775060130	X644163
4775060261	X644163
4775060280	X644205
4775060300	X644219
4775074010	X644199
4783002100	X275060
4783002260	X275072
4783005030	X275068
4783012151	X675046
4783012220	X275072
4783042060	X115002
4783042061	X115002
4783042080	X115002
4783052090	X675040
4783052161	X675040
4783060070	X645048
4783060080	X645048
4785002100	X275059
4785002280	X275071
4785005030	X275067
4785012151	X675045
4785012	

Références d'origine Etrier

O.E.M. - OE Nummern - Codigos originales - Codici originali

VAG		VAG		VAG		VAG		VAG		VOLVO	
535615424	X375032	1J0615424H	X375276	2K0615423B	X375329	4F0615404A	X377014	7L6615123H	X284107	8N0615424	X375144
701615123	X374145	1K0615123B	X224619	2K0615424	X375330	4F0615404B	X377020E	7L6615123J	X284089	8N0615424B	X375256
701615124	X374146	1K0615123C	X224725	2K0615424A	X375330	4F0615404C	X377008E	7L6615124F	X224628	8N0615424C	X375256
701615423	X375151	1K0615123D	X224455	2K0615424B	X375330	4F0615404D	X377026	7L6615124H	X284108	8P0 615 123A	X224743
701615424	X375152	1K0615123E	X224619	321615107B	X224067	4F0615404E	X377008E	7L6615124J	X284090	8P0615124A	X224742
857615123	X374359	1K0615123H	X224725	321615107B	X374051	4F0615404F	X377020E	7L6615149A	X284123		
857615124	X374151	1K0615124A	X224456	321615107C	X224067	4F0615404H	X377020E	7L6615150A	X284124		
893615123	X374038	1K0615124B	X224620	321615108B	X224068	535615423X	X375031	7L6615423	X225321	271362	X254019
893615124	X374037	1K0615124C	X224726	321615108B	X374052	535615424X	X375032	7L6615423G	X285063	271363	X254020
9024202302	X275002	1K0615124D	X224456	321615108C	X224068	5K0615423	X275065	7L6615423J	X285061	271365	X254070
9044200101	X614009	1K0615124E	X224620	321615123A	X224403	5K0615423A	X275065	7L6615424	X225322	271383	X374111
9044200201	X614010	1K0615124H	X224726	321615123A	X734007	5K0615424	X275066	7L6615424G	X285064	271384	X374112
113615107A	X224013	1K0615423	X375313	321615124A	X224404	5K0615424A	X275066	7L6615424J	X285062	825963	X224618
113615107B	X374053	1K0615423B	X375379	321615124A	X734008	5N0615105R	X224819	7M0615123A	X224449	1205897	X374093
113615108A	X224014	1K0615423C	X375313	331615107B	X224111	5N0615106R	X224820	7M0615123C	X224449	1205898	X374094
113615108B	X374054	1K0615423D	X375293	331615107C	X224111	5N0615123	X224819	7M0615124A	X224450	1206494	X375001
171615107A	X374063	1K0615423E	X375377	331615108B	X224112	5N0615124	X224820	7M0615124B	X224450	1206495	X375002
171615107C	X224375	1K0615423F	X375377	331615108C	X224112	5N0615403	X377001	7M0615124C	X375141	1207417	X374103
171615107D	X374052	1K0615423J	X375293	357615123A	X374037	5N0615403	X377001E	7M0615423	X375142	1207418	X374104
171615107E	X224131	1K0615423K	X375379	357615123AX	X374037	5N0615404	X377002	7M3615123	X224633	1221957	X374103
171615107F	X224115	1K0615423M	X375313	357615123BX	X374151	5N0615404	X377002E	7M3615123A	X224559	1221958	X374104
171615108A	X374064	1K0615424	X375314	357615123C	X374151	6E0615123	X224631	7M3615124	X224634	1229543	X374103
171615108C	X224376	1K0615424B	X375380	357615123CX	X374151	6E0615124	X224632	7M3615124A	X224560	1229544	X374104
171615108D	X374074	1K0615424C	X375314	357615124A	X374038	6K0615423B	X375123	7M0615123B	X224449	1229551	X225193
171615108E	X224132	1K0615424D	X375294	357615124AX	X374038	6K0615424B	X375124	7M0615123C	X224449	1273430	X374113
171615108F	X224116	1K0615424E	X375378	357615124B	X374038	6N0615123	X254203	7M0615124A	X224450	1329540	X374345
171615123B	X224403	1K0615424F	X375378	357615124C	X374152	6N0615123A	X254205	7M0615124B	X224450	1329541	X374346
171615123B	X734007	1K0615424J	X375294	357615124CX	X374152	6N0615123B	X254213	7M0615124C	X224450	1329642	X254173
171615124B	X224404	1K0615424K	X375380	357615124DX	X374152	6N0615123C	X374409	861615107C	X224091	1329643	X254174
171615124B	X734008	1K0615424M	X375314	357615124E	X374038	6N0615123CX	X374409	861615108C	X224092	1329768	X254069
191615423A	X375025	211615107A	X224155	3A0615123	X224249	6N0615123E	X374521	8A0615123	X374037	1329769	X254070
191615423AX	X375025	211615107B	X374055	3A0615124	X224250	6N0615124	X254204	8A0615124	X374038	1329866	X374109
191615423B	X375031	211615108A	X224156	3C0615403	X377003	6N0615124A	X254206	8D0615123	X374383	1329867	X374110
191615424A	X375026	211615108B	X374056	3C0615403	X377003E	6N0615124B	X254214	8D0615123X	X374383	1330303	X374103
191615424AX	X375026	251615107A	X374091	3C0615403A	X377005	6N0615124C	X374410	8D0615124	X374384	1330304	X374104
191615424B	X375032	251615107B	X374147	3C0615403A	X377005E	6N0615124E	X374522	8D0615124X	X374384	1330306	X374113
194615424B	X375032	251615108A	X374092	3C0615403E	X377003	6N0615124E	X374522	8E0615123	X374435	1330307	X374114
1H0615123A	X734007	251615108B	X374148	3C0615403E	X377003E	6N0615124F	X375123	8E0615123A	X224834	1330308	X375019
1H0615123B	X374205	251615123B	X374147	3C0615403F	X377005	6N0615124A	X375124	8E0615123B	X224651	1330309	X375020
1H0615123BX	X374205	251615123C	X224193	3C0615404	X377004	6Q0615123	X374615	8E0615123D	X374435	1330414	X225015
1H0615123C	X224453	251615123D	X374147	3C0615404	X377004E	6Q0615124	X374616	8E0615123E	X374435	1330416	X225045
1H0615124A	X374008	251615124B	X374148	3C0615404A	X377006	6Q0615124X	X374616	8E0615123F	X374435	1330417	X225046
1H0615124B	X374206	251615124C	X224194	3C0615404A	X377006E	6R0615423	X375275	8E0615124	X374436	1359229	X225193
1H0615124BX	X374206	251615124D	X374148	3C0615404E	X377004	6R0615424	X375276	8E0615124A	X224434	1359230	X375020
1H0615124C	X224454	281615107B	X224447	3C0615404E	X377004E	6U0615123X	X374203	8E0615124B	X224652	1359286	X375029
1H0615423	X375123	281615108B	X224448	3C0615404F	X377006	6U0615124X	X374204	8E0615124C	X374436	1359557	X254069
1H0615423A	X375123	291615107B	X224479	3D0615423	X375339	701615123C	X374263	8E0615124D	X374436	1359558	X254070
1H0615423B	X375123	291615108B	X224480	3D0615424	X375340	701615123D	X374391	8E0615423A	X375203	1459585	X224601
1H0615423DX	X375123	2D0615105A	X614009	411615107D	X224389	701615123X	X374145	8E0615423B	X375251	2713626	X254019
1H0615424	X375124	2D0615106A	X614010	411615108D	X224390	701615124C	X374264	8E0615423D	X375389	2713634	X254069
1H0615424A	X375124	2D0615123	X224489	443615123A	X374037	701615124D	X374392	8E0615424	X375166	2713659	X254070
1H0615424B	X375124	2D0615124	X224490	443615123F	X374359	701615124X	X374146	8E0615424A	X375204	2713832	X374111
1H0615424DX	X375124	2D0615423	X225133	443615123FX	X374133	7D0615123	X224483	8E0615424B	X375252	2713840	X374112
1J0615123A	X224455	2D0615423A	X225211	443615124A	X374038	7D0615123B	X224485	8E0615424D	X375390	3265983	X374105
1J0615123B	X224249	2D0615423B	X275001	443615124F	X374151	7D0615123C	X374263	8J0 615 123B	X224743	3265984	X374106
1J0615123C	X224249	2D0615423C	X274061	443615124FX	X374134	7D0615124	X224484	8J0 615 123C	X224743	3277715	X374105
1J0615123D	X224249	2D0615424	X225134	4B0615423	X375309	7D0615124B	X224486	8J0 615 123D	X224743	3277716	X374106
1J0615124	X224456	2D0615424A	X225212	4B0615424	X375310	7D0615124C	X374264	8J0 615 123E	X224743	3287423	X374095
1J0615124A	X224456	2D0615424B	X275002	4E0615123	X224738	7D0615124D	X374264	8J0615123B	X224741	3287424	X374096
1J0615124B	X224250	2D0615424C	X274062	4E0615403B	X377023	7D0615124E	X375153	8J0615124B	X224742	3342527	X225002
1J0615124C	X224250	2E0615101	X284099	4E0615403C	X377023	7D0615424A	X375154	8J0615124C	X224742	3342780	X374001
1J0615124D	X224250	2E0615101A	X284087	4E0615404B	X377024	7H0615123	X224721	8J0615124D	X224742	3342781	X374002
1J0615423	X375143	2E0615102	X284100	4E0615404C	X377024	7H0615123A	X224627	8J0615124E	X224742	3342827	X225001
1J0615423A	X375191	2E0615102A	X284088	4F0615403	X377025	7H0615124	X224722	8J0615423	X375377	3342828	X225002
1J0615423B	X375193	2E0615105A	X284087	4F0615403A	X377013	7H0615124A	X224628	8J0615424	X375378	3344058	X374101
1J0615423D	X375275	2E0615105C	X284087	4F0615403B	X377019E	7H0615423	X375315	8K0615123C	X224785	3344059	X374102
1J0615423G	X375275	2E0615106A	X284088	4F0615403C	X377007E	7H0615423A	X375315	8K0615124C	X224786	3344684	X224419
1J0615424	X375144	2E0615106C	X284088	4F0615403D	X377025	7H0615424	X375316	8K0615403B	X377027	3344685	X224420
1J0615424A	X375192	2E0615405B	X275045	4F0615403F	X377007E	7H0615424A	X375316	8K0615404B	X377028	3345674	X375147
1J0615424B	X375194	2E0615406B	X275046	4F0615403G	X377019E	7H8615423	X225355	8N0615423	X375143	3414574	X374001
1J0615424D	X375276	2K0615423	X375329	4F0615403H	X377019E	7H8615424	X225356	8N0615423B	X375255	3414575	X374002
1J0615424F	X375276	2K0615423A	X375329	4F0615404	X377026	7L6615123F	X224627	8N0615423C	X375255	3516317	X225071

Références d'origine Etrier

O.E.M. - OE Nummern - Codigos originales - Codici originali

VOLVO	
3516318	X225072
3516513	X374111
3516514	X374112
3516517	X374109
3516518	X374110
3516565	X374143
3516566	X374144
3516840	X224303
3516841	X224304
3530755	X225015
3530756	X225016
3530757	X225045
3530758	X225046
3530759	X225045
3530759	X225065
3530760	X225046
3530760	X225066
3530761	X375065
3530761	X375066
3530762	X375066
3546491	X225071
3546492	X225072
5002028	X374113
5002029	X374114
5003514	X225045
5003515	X225046
5003573	X225065
5003574	X225066
5003744	X374143
5003745	X374144
5003811	X224304
5003812	X224303
5003813	X225072
5003814	X225071
5003848	X375065
5003947	X225045
5003948	X225046
5003949	X225045
5003950	X225046
6578462	X374033
6578470	X374034
6819144	X375065
6844328	X374019
6844336	X374020
8111055	X374109
8111057	X374143
8111058	X374144
8111059	X254069
8111060	X254070
8111062	X254020
8111063	X374111
8111064	X374112
8111085	X374109
8111086	X374110
8111101	X224303
8111102	X224304
8111104	X375065
8111743	X374369
8111744	X374370
8111958	X274049
8111959	X274050
8251312	X225265
8251313	X225266
8251315	X224565
8251317	X224566
8251696	X375147
8251697	X375148
8252177	X224691
8252178	X224692
8252901	X374453
8252902	X374454
8252907	X375197

VOLVO	
8252908	X375198
8253026	X274055
8253027	X274056
8253028	X274053
8253029	X274054
8253294	X374631
8253295	X374632
8253296	X375343
8253297	X375344
8253331	X274055
8253332	X274056
8253651	X375217
8253652	X375218
8253962	X224617
8253963	X224618
8253964	X224591
8253965	X224563
8253966	X224564
8253967	X225245
8253968	X225246
8253986	X224592
8472231	X285005
8472232	X285006
8472238	X374453
8472239	X374454
8472299	X375246
8472300	X375245
8601556	X224565
8601557	X224566
8601559	X224566
8601560	X225265
8601561	X225266
8601763	X225381
8601765	X225382
8601977	X375233
8601978	X375234
8602006	X225071
8602076	X374401
8602077	X374402
8602078	X375147
8602079	X375148
8602144	X374401
8602145	X374402
8602150	X375147
8602151	X375148
8602328	X225381
8602329	X225382
8602344	X224303
8602498	X224303
8602499	X224304
8602554	X375030
8602676	X224565
8602677	X224566
8602682	X284151
8602683	X284152
8602684	X285071
8602685	X285072
8602725	X225325
8602726	X225326
8602739	X224691
8602740	X224692
8602799	X224637
8602800	X224638
8602854	X225325
8602855	X225326
8602857	X224637
8602858	X224638
8602898	X224691
8602899	X224692
8602907	X224601
8602908	X224602

VOLVO	
8602911	X225281
8602912	X225282
8603113	X224684
8603386	X224683
8603387	X224684
8603444	X224565
8603446	X225265
8603447	X225266
8603722	X375357
8603723	X375358
8603724	X377033
8603725	X377034
8603726	X377041
8603727	X377042
8603735	X225281
8603736	X225282
8603753	X224663
8603754	X224664
8603755	X224715
8603756	X224716
8603938	X224601
8603939	X224602
8603942	X224683
8603943	X224684
9031057	X374095
9031058	X374096
9031107	X374002
9031108	X225001
9031109	X225002
9031159	X374101
9031160	X374102
9031501	X224419
9031502	X224420
9031505	X374001
9031507	X374101
9031508	X374102
9031511	X224419
9034106	X374001
9140392	X225065
9140393	X225066
9140394	X375065
9142039	X224303
9142040	X224304
9157434	X224303
9157435	X224304
9157439	X225071
9157440	X225072
9157451	X374143
9157452	X374144
9173299	X224303
9173300	X224304
9173735	X375030
9200131	X224303
9200132	X224304
9209730	X375065
9475268	X224689
9475270	X224690
9475386	X225381
9475387	X225382
9485265	X224303
9485266	X224304
9492269	X224565
9492270	X224566
12058954	X224121
12058962	X224122
12059580	X375019
12059598	X375020
12059747	X224119
12059754	X224120
12064846	X374019
12064853	X374020
12064929	X224053

VOLVO	
12064937	X224054
12064941	X375001
12064941	X375009
12064945	X225021
12064952	X225022
12064959	X375002
12064959	X375010
12064960	X224055
12064978	X224056
12068486	X374019
12074175	X374103
12074183	X374104
12219572	X374103
12219580	X374104
12283453	X374113
12283461	X374114
12295432	X374103
12295440	X374104
12295442	X374104
12295515	X225039
12295515	X225193
12295523	X225040
12295523	X225194
12734307	X374113
12734315	X374114
12736658	X225119
12736666	X225120
12955515	X225193
12955523	X225194
13296421	X254019
13296421	X254201
13296439	X254020
13296439	X254202
13297684	X254069
13297692	X254070
13298666	X374109
13298674	X374110
13303037	X374103
13303045	X374104
13303086	X375019
13303094	X375020
13304142	X225015
13304159	X225016
13304167	X225045
13304167	X225291
13304175	X225046
13304175	X225292
13304183	X225065
13304183	X225293
13304191	X225066
13304191	X225294
13592290	X225039
13592290	X225193
13592308	X225040
13592308	X225194
13592308	X375020
13592860	X375029
13592860	X375030
13595574	X254069
13595582	X254070
13879457	X225065
13879457	X225293
13879465	X225066
13879465	X225294
25165653	X374143
25168400	X224303
30639523	X225325
30639525	X225326
30863315	X375147
30863316	X375148
32052063	X374367
32052064	X374368

VOLVO	
32165174	X374109
32659831	X374105
32659849	X374106
32777153	X374105
32777161	X374106
32944415	X374095
32944423	X374096
33425265	X225001
33427808	X374001
33427816	X374002
33428277	X225001
33428285	X225002
33440587	X374101
33440595	X374102
33446840	X224419
33446857	X224420
33456674	X374401
33456682	X374402
33456740	X375147
33456757	X375148
35155182	X374110
35163179	X225071
35163187	X225072
35165117	X374111
35165125	X374112
35165174	X374109
35165182	X374110
35166563	X374143
35166561	X374144
35168400	X224303
35168418	X224304
35169418	X224304
35307552	X225015
35307560	X225016
35307576	X225045
35307576	X225291
35307586	X225046
35307586	X225292
35307594	X225065
35307594	X225293
35307602	X225066
35307602	X225294
35464916	X225071
35464924	X225072
36000150	X224714
36000151	X224713
36000375	X224715
36000376	X224716
36000484	X224601
36000485	X224602
36000704	X224684
36000724	X224565
36000726	X224566
36000728	X225265
36000730	X225266
36000731	X224683
36000732	X224684
36000900	X225445
36000901	X225446
36000902	X225281
36000903	X225282
36001375	X377033
36001377	X377034
36001379	X377041
36001380	X377042
36001381	X377042
36001382	X377041
36001703	X225445
36001704	X225446
36001765	X225445
36001766	X225446
36002410	X224876

VOLVO	
36002411	X224875
50027382	X254019
50027390	X254020
50028091	X254019
50028109	X254020
50028836	X254069
50028844	X254070
50035104	X374109
50035112	X374110
50035888	X374111
50036482	X375029
50036482	X375030
50036888	X374111
50036896	X374112
50036904	X374109
50036912	X374110
50037449	X374143
50037456	X374144
50038116	X224304
50038124	X224303
50038132	X225072
50038140	X225071
50038488	X375065
50038488	X375066
50039494	X225065
50039494	X225293
50039502	X225066
50039502	X225294
68191444	X375065
68191444	X375066
81110553	X374109
81110561	X374110
81110577	X374143
81110579	X374143
81110587	X374144
81110595	X254069
81110603	X254070
81110603	X254174
81110611	X254019
81110637	X374111
81110645	X374112
81110850	X374109
81110868	X374110
81111015	X224303
81111023	X224304
81111031	X375029
81111031	X375030
81111049	X375065
81111049	X375066
86020062	X225071
86020765	X374401
86020773	X374402
86020775	X374402
86020781	X375147
86020799	X375148
86021508	X375147
86021516	X375148
86	

Références d'origine Etrier

O.E.M. - OE Nummern - Codigos originales - Codici originali

VOLVO	
90315094	X225001
90315102	X225002
90315110	X224419
90315128	X224420
91403923	X225065
91403931	X225066
91403949	X375065
91403949	X375066
91420398	X224303
91420406	X224304
91574343	X224303
91574350	X224304
91574392	X225071
91574400	X225072
91574517	X374143
91574525	X374144
91732990	X224303
91733006	X224304
91737353	X225046
91737353	X375029
91737353	X375030
92001312	X224303
92001320	X224304
308633072	X374419
308633080	X374420
308633155	X375147
308633163	X375148
360001380	X377042
3M512B302BA	X224601
BPYK3361XB	X224602
BPYK3361XC	X224602
BPYK3371XB	X224601
BPYK3371XC	X224601
LRG502	X374245
LRG503	X374246
LRG504	X374247
LRG505	X374248
LRG604	X375071
LRG605	X375072
LRG606	X375073
LRG607	X375074
VW	
113615107	X224069
113615108	X224070
141615107	X224069
141615108	X224070
171615123	X224401
171615124	X224402
211615108	X224044
251615107	X224065
251615107	X224155
251615108	X224066
251615108	X224156
281615107	X224447
281615108	X224448
291615107	X224479
291615108	X224480
311615107	X224011
311615107	X225007
311615108	X224012
311615108	X225008
357615123	X224401
357615124	X224402
441615107	X224467
443615123	X374037
443615124	X374038
701615123	X374145
701615124	X374146
701615423	X375153
701615424	X375154
893615123	X374037



VW	
893615124	X374038
34211150275	X224011
34211150276	X224012
113615107A	X224069
113615108A	X224070
171615107A	X374338
171615107B	X374052
171615107C	X224375
171615107E	X224132
171615107F	X224115
171615108A	X374337
171615108B	X374074
171615108C	X224376
171615108D	X374074
171615108E	X224132
171615108F	X224116
171615123B	X224401
171615123B	X734001
171615124B	X224402
171615124B	X734002
191615423A	X375025
191615424A	X375026
1A8615123	X374192
1H0615123C	X224453
1H0615124C	X224454
1H0615423D	X375123
1H0615424D	X375124
1J0615423C	X375313
1J0615423E	X375255
1J0615423F	X375275
1J0615424C	X375314
1J0615424E	X375256
1K0615123	X224619
1K0615123A	X224455
1K0615123B	X224619
1K0615123D	X224455
1K0615123F	X224619
1K0615123G	X224725
1K0615123J	X224725
1K0615123M	X224619
1K0615124	X224620
1K0615124B	X224620
1K0615124F	X224620
1K0615124G	X224726
1K0615124J	X224726
1K0615124M	X224620
1K0615423D	X375293
1K0615423G	X375379
1K0615423L	X375377
1K0615423N	X375377
1K0615423P	X375377
1K0615424D	X375294
1K0615424G	X375380
1K0615424L	X375378
1K0615424N	X375378
1K0615424P	X375378
215615107B	X374055
215615108B	X374056
251615107A	X374055
251615107A	X374091
251615107B	X374147
251615108A	X374056
251615108A	X374092
251615108B	X374148
251615123B	X374147
251615123C	X224193
251615123D	X374147
251615124B	X374148
251615124C	X224194
251615124D	X374148
281615107B	X224447
281615108B	X224448



VW	
291615107B	X224479
291615108B	X224480
2D0615105A	X614009
2D0615105B	X614009
2D0615106A	X614010
2D0615106B	X614010
2D0615123	X224491
2D0615123A	X274013
2D0615124	X224492
2D0615124A	X274014
2D0615423A	X225211
2D0615423B	X275001
2D0615424A	X225212
2D0615424B	X275002
2E0615405B	X275045
2E0615406B	X275046
2E0615423	X275045
2E0615423A	X275039
2E0615424	X275046
2E0615424A	X275040
2H0615123	X274111
2H0615124	X274112
2K0615423	X375329
2K0615423A	X375329
2K0615423B	X375329
2K0615423C	X375397
2K0615424	X375330
2K0615424A	X375330
2K0615424B	X375330
2K0615424C	X375398
2K5615423	X275073
2K5615424	X275074
311615107B	X224063
311615108B	X224064
321615123A	X224401
321615124A	X224402
331615107B	X224376
331615108B	X224375
357615123B	X374151
357615123C	X374151
357615124B	X374359
357615124B	X374359
357615124C	X374359
357615124CX	X374359
3C0615403	X377003
3C0615403B	X377039
3C0615403E	X377003
3C0615403H	X377039
3C0615404	X377004
3C0615404B	X377040
3C0615404E	X377004
3C0615404H	X377040
411615107C	X224388
411615108C	X224387
443615107C	X224181
443615108C	X224182
443615123E	X224181
443615124E	X224182
4A0615107	X374385
4A0615107A	X374765
4A0615108A	X374766
4B0615107	X374757
4B0615108	X374758
4D0615107A	X374407
4D0615107B	X374651
4D0615108A	X374408
4D0615108B	X374652
4G0615123A	X374735
4G0615123B	X224857
4G0615123C	X374733
4G0615123D	X374735
4G0615124A	X374736

VW	
4G0615124B	X224858
4G0615124C	X374734
4G0615124D	X374736
4G0615403	X377043
4G0615403B	X377049
4G0615403C	X377047
4G0615404	X377044
4G0615404B	X377050
4G0615404C	X377048
5G0615123	X374759
5G0615123C	X374759
5G0615123E	X374759
5G0615124	X374760
5G0615124C	X374760
5G0615124E	X374760
6E0615123	X224631
6E0615124	X224632
6K0615423B	X375141
6K0615424B	X375142
6N0615123	X254203
6N0615123C	X374409
6N0615123CX	X374409
6N0615124	X254204
6N0615124C	X374410
6N0615124CX	X374410
6N0615423	X375123
6N0615423A	X375253
6N0615423B	X375253
6N0615424	X375124
6N0615424A	X375254
6N0615424B	X375254
6Q0615123A	X374615
6Q0615124	X374616
6Q0615124A	X374616
6Q0615423B	X375299
6Q0615424B	X375300
6R0615423A	X375275
6R0615424A	X375276
701615123C	X374263
701615123D	X374391
701615123DX	X374391
701615123X	X374145
701615124C	X374264
701615124DX	X374392
701615124X	X374146
701698480AX	X374145
701698480AX	X374146
701698480X	X374391
701698480X	X374392
7D0615123	X224483
7D0615123B	X224485
7D0615124	X224484
7D0615124B	X224486
7D0615423A	X375153
7D0615423B	X375153
7D0615424A	X375154
7D0615424B	X375154
7D1615123C	X374263
7D1615124C	X374264
7H0615123B	X224721
7H0615124B	X224722
7H0615423	X375315
7H0615423A	X375315
7H0615424	X375316
7H0615424A	X375316
7L6615123F	X224627
7L6615123M	X284107
7L6615123N	X284089
7L6615123Q	X284089
7L6615123R	X284123
7L6615123S	X284161
7L6615123T	X284107

VW	
7L6615124F	X224628
7L6615124M	X284108
7L6615124N	X284090
7L6615124Q	X284090
7L6615124R	X284124
7L6615124S	X284162
7L6615124T	X284108
7L6615149	X284089
7L6615150	X284090
7L6615423H	X285063
7L6615423K	X285073
7L6615423L	X285063
7L6615424H	X285064
7L6615424K	X285074
7L6615424L	X285064
7L8615423	X285095
7L8615423A	X285095
7L8615424	X285096
7L8615424A	X285096
7L9615123	X284161
7L9615124	X284162
7L9615403B	X285073
7L9615404B	X285074
7L9615423	X285073
7L9615424	X285074
7M0615123B	X224449
7M0615124C	X224450
7M0615423	X375141
7M0615424	X375142
7M3615123	X224633
7M3615123A	X224559
7M3615124	X224634
7M3615124A	X224560
841615107A	X224132
841615108A	X224132
8J0615124A	X224620
8J0615423B	X375379
8J0615423C	X375377
8J0615423E	X375379
8J0615423F	X375377
8J0615424B	X375380
8J0615424C	X375378
8J0615424E	X375380
8J0615424F	X375378
8K0615123	X374675
8K0615123B	X374675
8K0615123D	X374735
8K0615123E	X374735
8K0615123J	X374735
8K0615124	X374676
8K0615124B	X374676
8K0615124D	X374736
8K0615124E	X374736
8K0615124J	X374736
8L0615123	X224249
8L0615124	X224250
8V0615123A	X374759
8V0615123D	X374759
8V0615124A	X374760
8V0615124D	X374760
95VW2B118CA	X375142
95VW2B119CA	X375141
J4773026080	X194006
J4775026080	X194005
YM212B118AA	X375154
YM212B118CA	X224634
YM212B118DA	X224560
YM212B119AA	X375153
YM212B119CA	X224633
YM212B119DA	X224559



WARTBURG	
9117002197000	X604001
WARTBURG	
9117002180000	X604002



X104001			
	#	1	∅ 48
			
	441149		

X104002			
	#	1	∅ 48
			
	441149		

X104003			
	#	1	∅ 52
			
			



X104004			
	#	1	∅ 52
			
			



X104005			
	#	1	∅ 48
			
	441149		



X104006			
	#	1	∅ 48
			
	441149		

X104007			
	#	1	∅ 52
			
	441171		



X104008			
	#	1	∅ 52
			
	441171		

X104009			
	#	1	∅ 54
			
	441690		

X104010			
	#	1	∅ 54
			
	441690		

X104011			
	#	1	∅ 52
			
	441171		

X104012			
	#	1	∅ 52
			
	441171		

X104013			
	#	1	∅ 48
			
	441149		

X104014			
	#	1	∅ 48
			
	441149		

X104015			
	#	1	∅ 48
			
	441149		

X104016			
	#	1	∅ 48
			
	441149		



X104017				
	#	1	∅	54
	441690			

X104018				
	#	1	∅	54
	441690			

X104019				
	#	1	∅	52
	441171			

X104020				
	#	1	∅	52
	441171			

X104021				
	#	1	∅	48
	441149			

X104022				
	#	1	∅	48
	441149			

X104023				
	#	1	∅	48
	441149			

X104024				
	#	1	∅	48
	441149			

X104025				
	#	1	∅	48

X104026				
	#	1	∅	48

X114001				
	#	1	∅	60
	442193			

X114002				
	#	1	∅	60
	442193			



X114003				
	#	2	∅	45
	442118			

X114004				
	#	2	∅	45
	442118			

X114005				
	#	1	∅	54
	441489			

X114006				
	#	1	∅	54
	441489			









X114007			
	# 4	∅ 43	
			
		442256	



X114008			
	# 4	∅ 43	
			
		442256	



X114009			
	# 1	∅ 63,4	
			
		441584	



X114010			
	# 1	∅ 63,4	
			
		441584	



X114011			
	# 1	∅ 60	
			
			

X114012			
	# 1	∅ 60	
			
			

X114013			
	# 1	∅ 60	
			
		442193	



X114014			
	# 1	∅ 60	
			
		442193	



X114015			
	# 4	∅ 43	
			
		442256	

X114016			
	# 4	∅ 43	
			
		442256	

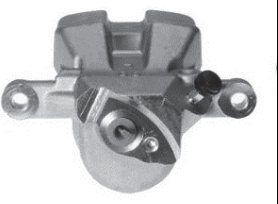
X114017			
	# 1	∅ 60	
			
			

X114018			
	# 1	∅ 60	
			
			

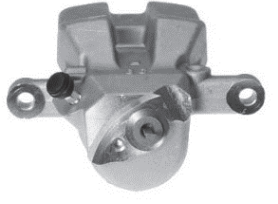
X115001			
	# 1	∅ 38	
			
		441580	

X115002			
	# 1	∅ 38	
			
		441580	

X115003			
	# 1	∅ 45	
			
			

X115004			
	# 1	∅ 45	
			
			



X115005				
	#	1	∅	43

X115006				
	#	1	∅	43

X134001				
	#	1	∅	51
	441526			

X134002				
	#	1	∅	51
	441526			

X134003				
	#	1	∅	48
	441924			

X134004				
	#	1	∅	48
	441924			

X134007				
	#	1	∅	67
	441764			

X134008				
	#	1	∅	67
	441764			

X134009				
	#	1	∅	67
	442158			

X134010				
	#	1	∅	67
	442158			

X134011				
	#	1	∅	51
	441526			

X134012				
	#	1	∅	51
	441526			

X134015				
	#	1	∅	67
	441764			

X134016				
	#	1	∅	67
	441764			

X134017				
	#	1	∅	67

X134018				
	#	1	∅	67



X134019				
	#	2	∅	51

X134020				
	#	2	∅	51

X134021				
	#	2	∅	38
		441867		

X134022				
	#	2	∅	38
		441867		

X134023				
	#	2	∅	36
		441921		

X134024				
	#	2	∅	36
		441921		

X134025				
	#	2	∅	36
		441921		

X134026				
	#	2	∅	36
		441921		

X134027				
	#	1	∅	57
		441606		

X134028				
	#	1	∅	57
		441606		

X134029				
	#	1	∅	67
		442083		

X134030				
	#	1	∅	67
		442083		



X134031				
	#	1	∅	67
		442083		



X134032				
	#	1	∅	67
		442083		



X134033				
	#	2	∅	45
		442077		



X134034				
	#	2	∅	45
		442077		









X134035				
	#	2	∅	45
				
	442077			



X134036				
	#	2	∅	45
				
	442077			



X134037				
	#	2	∅	40
				
	441977			



X134038				
	#	2	∅	40
				
	441977			



X134039				
	#	2	∅	45
				
	442077			



X134040				
	#	2	∅	45
				
	442077			



X134041				
	#	1	∅	51
				
				



X134042				
	#	1	∅	51
				
				



X134043				
	#	1	∅	54
				
	442100			



X134044				
	#	1	∅	54
				
	442100			



X134045				
	#	1	∅	54
				
	442100			

X134046				
	#	1	∅	54
				
	442100			

X134047				
	#	2	∅	40
				
	441977			

X134048				
	#	2	∅	40
				
	441977			

X134049				
	#	1	∅	51
				
	442148			

X134050				
	#	1	∅	51
				
	442148			



X134051				
	#	1	∅	51
				441952

X134052				
	#	1	∅	51
				441952

X134053				
	#	1	∅	51
				441952

X134054				
	#	1	∅	51
				441952

X134057				
	#	1	∅	51
				442123

X134058				
	#	1	∅	51
				442123

X134059				
	#	1	∅	57
				441606

X134060				
	#	1	∅	57
				441606

X134061				
	#	2	∅	45
				442077

X134062				
	#	2	∅	45
				442077

X134063				
	#	1	∅	51
				441952

X134064				
	#	1	∅	51
				441952



X134065				
	#	1	∅	57
				441606



X134066				
	#	1	∅	57
				441606

X134067				
	#	1	∅	57
				442151

X134068				
	#	1	∅	57
				442151







X134069				
	#	1	∅	54
				
	441227			

X134070				
	#	1	∅	54
				
	441227			



X134071				
	#	1	∅	57
				
				

X134072				
	#	1	∅	57
				
				

X134073				
	#	1	∅	51
				
				



X134074				
	#	1	∅	51
				
				

X134075				
	#	1	∅	63
				
				



X134076				
	#	1	∅	63
				
				



X135001				
	#	1	∅	32
				
	442088			

X135002				
	#	1	∅	32
				
	442088			

X135003				
	#	1	∅	35
				
	441920			

X135004				
	#	1	∅	35
				
	441920			





X135005				
	#	1	∅	38
				
	442018			





X135006				
	#	1	∅	38
				
	442018			





X135007				
	#	1	∅	43
				
	442017			

X135008				
	#	1	∅	43
				
	442017			











X135009				
	#	1	∅	40
				
		442109		





X135010				
	#	1	∅	40
				
		442109		

X135011				
	#	1	∅	43
				
		442114		

X135012				
	#	1	∅	43
				
		442114		

X135013				
	#	1	∅	43
				
				





X135014				
	#	1	∅	43
				
				





X135015				
	#	1	∅	43
				
		442114		



X135016				
	#	1	∅	43
				
		442114		

X135017				
	#	1	∅	38
				
		442107		





X135018				
	#	1	∅	38
				
		442107		





X135019				
	#	2	∅	40
				
		442257		

X135020				
	#	2	∅	40
				
		442257		

X135021				
	#	1	∅	35
				
		442162		

X135022				
	#	1	∅	35
				
		442162		

X135023				
	#	1	∅	35
				
		442162		

X135024				
	#	1	∅	35
				
		442162		



X135027				
	#	1	∅	40
	442316			

X135028				
	#	1	∅	40
	442316			

X135029				
	#	1	∅	38

X135030				
	#	1	∅	38

X164001				
	#	1	∅	48
	441717			

X164002				
	#	1	∅	48
	441717			

X164003				
	#	1	∅	54
	441539			

X164004				
	#	1	∅	54
	441539			

X164005				
	#	1	∅	54
	442125			

X164006				
	#	1	∅	54
	442125			

X164007				
	#	1	∅	54
	441844			

X164008				
	#	1	∅	54
	441844			



X164009				
	#	1	∅	51
	441767			



X164010				
	#	1	∅	51
	441767			



X164011				
	#	1	∅	51
	441889			



X164012				
	#	1	∅	51
	441889			







X164013				
	#	1	∅	57
				
	441721			

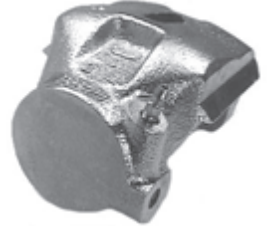

X164014				
	#	1	∅	57
				
	441721			

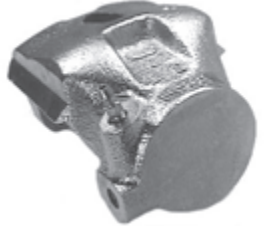

X164015				
	#	1	∅	48
				
	441766			



X164016				
	#	1	∅	48
				
	441766			



X164017				
	#	1	∅	51
				
				



X164018				
	#	1	∅	51
				
				



X164019				
	#	1	∅	54
				
	441985			



X164020				
	#	1	∅	54
				
	441985			



X164021				
	#	1	∅	51
				
				



X164022				
	#	1	∅	51
				
				



X164025				
	#	1	∅	54
				
	441985			

X164026				
	#	1	∅	54
				
	441985			

X164027				
	#	1	∅	54
				
	441902			

X164028				
	#	1	∅	54
				
	441902			

X164029				
	#	1	∅	48
				
				

X164030				
	#	1	∅	48
				
				



X164031				
	#	1	∅	51
	441719			

X164032				
	#	1	∅	51
	441719			

X164033				
	#	1	∅	54
	441756			

X164034				
	#	1	∅	54
	441756			

X164035				
	#	1	∅	51
	441719			

X164036				
	#	1	∅	51
	441719			

X164037				
	#	1	∅	51

X164038				
	#	1	∅	51

X164039				
	#	1	∅	54

X164040				
	#	1	∅	54

X164041				
	#	1	∅	51
	441719			

X164042				
	#	1	∅	51
	441719			

X164043				
	#	1	∅	51
	441719			

X164044				
	#	1	∅	51
	441719			

X164045				
	#	1	∅	54
	441892			

X164046				
	#	1	∅	54
	441892			



X164049			
	#	1	∅ 51
	441719		

X164050			
	#	1	∅ 51
	441719		

X164055			
	#	1	∅ 51

X164056			
	#	1	∅ 51

X164057			
	#	1	∅ 51

X164058			
	#	1	∅ 51

X164061			
	#	1	∅ 57

X164062			
	#	1	∅ 57

X164065			
	#	2	∅ 43
	441864		

X164066			
	#	2	∅ 43
	441864		

X164067			
	#	1	∅ 57
	441963		

X164068			
	#	1	∅ 57
	441963		



X164069			
	#	1	∅ 60
	441953		



X164070			
	#	1	∅ 60
	441953		



X164071			
	#	2	∅ 43
	441872		



X164072			
	#	2	∅ 43
	441872		









X164073				
	#	1	∅	51
				
	441719			

X164074				
	#	1	∅	51
				
	441719			



X164075				
	#	1	∅	51
				
	442204			



X164076				
	#	1	∅	51
				
	442204			



X164077				
	#	1	∅	54
				
	441676			



X164078				
	#	1	∅	54
				
	441676			



X164079				
	#	1	∅	54
				
	441676			



X164080				
	#	1	∅	54
				
	441676			



X164081				
	#	1	∅	51
				
	441986			



X164082				
	#	1	∅	51
				
	441986			



X164083				
	#	1	∅	54
				
	441668			

X164084				
	#	1	∅	54
				
	441668			



X164085				
	#	1	∅	57
				
	441671			



X164086				
	#	1	∅	57
				
	441671			

X164087				
	#	1	∅	54
				
	441985			



X164088				
	#	1	∅	54
				
	441985			









X164089				
	#	1	∅	54
				
	441676			

X164090				
	#	1	∅	54
				
	441676			

X164091				
	#	1	∅	51
				
				



X164092				
	#	1	∅	51
				
				



X164093				
	#	1	∅	51
				
				



X164094				
	#	1	∅	51
				
				



X164095				
	#	1	∅	51
				
				



X164096				
	#	1	∅	51
				
				



X164097				
	#	1	∅	54
				
	441743			



X164098				
	#	1	∅	54
				
	441743			



X164103				
	#	1	∅	54
				
	441743			

X164104				
	#	1	∅	54
				
	441743			



X164107				
	#	1	∅	54
				
	441534			



X164108				
	#	1	∅	54
				
	441534			

X164109				
	#	1	∅	54
				
				



X164110				
	#	1	∅	54
				
				









X164115				
	#	1	∅	54
				
				



X164116				
	#	1	∅	54
				
				

X164117				
	#	1	∅	60
				
	441736			

X164118				
	#	1	∅	60
				
	441736			



X164119				
	#	1	∅	54
				
	441676			



X164120				
	#	1	∅	54
				
	441676			



X164121				
	#	1	∅	54
				
	441539			



X164122				
	#	1	∅	54
				
	441539			



X164123				
	#	1	∅	54
				
	441757			

X164124				
	#	1	∅	54
				
	441757			

X164125				
	#	1	∅	54
				
	441902			

X164126				
	#	1	∅	54
				
	441902			

X164127				
	#	1	∅	57
				
	441846			

X164128				
	#	1	∅	57
				
	441846			

X164129				
	#	1	∅	57
				
	441846			

X164130				
	#	1	∅	57
				
	441846			



X164131				
	#	1	∅	60

X164132				
	#	1	∅	60

X164133				
	#	1	∅	57
	441861			

X164134				
	#	1	∅	57
	441861			

X164135				
	#	1	∅	54
	441676			

X164136				
	#	1	∅	54
	441676			

X164139				
	#	1	∅	48
	441827			

X164140				
	#	1	∅	48
	441827			

X164141				
	#	1	∅	54

X164142				
	#	1	∅	54

X164143				
	#	1	∅	54
	441534			

X164144				
	#	1	∅	54
	441534			

X164149				
	#	1	∅	57

X164150				
	#	1	∅	57

X164151				
	#	1	∅	51

X164152				
	#	1	∅	51



X164153				
	#	1	∅	51

X164154				
	#	1	∅	51

X164155				
	#	1	∅	44

X164156				
	#	1	∅	44

X164157				
	#	1	∅	48

X164158				
	#	1	∅	48

X164161				
	#	1	∅	51
	441719			

X164162				
	#	1	∅	51
	441719			

X164163				
	#	1	∅	54

X164164				
	#	1	∅	54

X164167				
	#	1	∅	54

X164168				
	#	1	∅	54

X164169				
	#	1	∅	48
	441599			

X164170				
	#	1	∅	48
	441599			

X164171				
	#	1	∅	51
	441719			

X164172				
	#	1	∅	51
	441719			



X164177				
	#	1	∅	54
	441534			

X164178				
	#	1	∅	54
	441534			

X164179				
	#	1	∅	51
	441774			

X164180				
	#	1	∅	51
	441774			

X164181				
	#	1	∅	54

X164182				
	#	1	∅	54

X164185				
	#	1	∅	51
	441767			

X164186				
	#	1	∅	51
	441767			

X164187				
	#	1	∅	51

X164188				
	#	1	∅	51

X164191				
	#	1	∅	51

X164192				
	#	1	∅	51

X164193				
	#	1	∅	51

X164194				
	#	1	∅	51

X164195				
	#	1	∅	51
	442204			

X164196				
	#	1	∅	51
	442204			



X164197				
	#	1	∅	60
	441736			

X164198				
	#	1	∅	60
	441736			

X164199				
	#	1	∅	54
	441998			

X164200				
	#	1	∅	54
	441998			

X164201				
	#	1	∅	54
	441853			

X164202				
	#	1	∅	54
	441853			

X164203				
	#	1	∅	54
	441756			

X164204				
	#	1	∅	54
	441756			

X164205				
	#	1	∅	57
	442081			

X164206				
	#	1	∅	57
	442081			

X164207				
	#	2	∅	43
	441875			

X164208				
	#	2	∅	43
	441875			



X164209				
	#	1	∅	60
	441877			



X164210				
	#	1	∅	60
	441877			



X164211				
	#	2	∅	43
	442016			



X164212				
	#	2	∅	43
	442016			









X164215				
	#	1	∅	54
				
	441853			

X164216				
	#	1	∅	54
				
	441853			



X164217				
	#	1	∅	60
				
	441877			



X164218				
	#	1	∅	60
				
	441877			



X164219				
	#	2	∅	43
				
	441875			



X164220				
	#	2	∅	43
				
	441875			



X164221				
	#	2	∅	45
				
	441914			



X164222				
	#	2	∅	45
				
	441914			

X164223				
	#	1	∅	60
				
	441753			



X164224				
	#	1	∅	60
				
	441753			

X164225				
	#	1	∅	60
				
	441876			

X164226				
	#	1	∅	60
				
	441876			

X164227				
	#	2	∅	43
				
	441875			

X164228				
	#	2	∅	43
				
	441875			

X164229				
	#	1	∅	54
				
	441998			

X164230				
	#	1	∅	54
				
	441998			



X164231				
	#	1	∅	60
				441873

X164232				
	#	1	∅	60
				441873

X164233				
	#	2	∅	43
				441875

X164234				
	#	2	∅	43
				441875

X164237				
	#	2	∅	43
				441875

X164238				
	#	2	∅	43
				441875

X164239				
	#	1	∅	60
				441877

X164240				
	#	1	∅	60
				441877

X164241				
	#	1	∅	51

X164242				
	#	1	∅	51

X164243				
	#	1	∅	51
				441886

X164244				
	#	1	∅	51
				441886

X164247				
	#	2	∅	43
				441872

X164248				
	#	2	∅	43
				441872

X164249				
	#	2	∅	45

X164250				
	#	2	∅	45



X164251				
	#	2	∅	43
		442028		

X164252				
	#	2	∅	43
		442028		

X164255				
	#	1	∅	54
		441676		

X164256				
	#	1	∅	54
		441676		

X164259				
	#	1	∅	54

X164260				
	#	1	∅	54

X164261				
	#	1	∅	60

X164262				
	#	1	∅	60

X164265				
	#	2	∅	43
		442227		

X164266				
	#	2	∅	43
		442227		

X164269				
	#	1	∅	54
		441993		

X164270				
	#	1	∅	54
		441993		

X164271				
	#	2	∅	45
		442060		

X164272				
	#	2	∅	45
		442060		

X164273				
	#	1	∅	60
		441873		

X164274				
	#	1	∅	60
		441873		



X164275			
	#	1	∅ 63,5
	442092		

X164276			
	#	1	∅ 63,5
	442092		

X164277			
	#	1	∅ 57
	441991		

X164278			
	#	1	∅ 57
	441991		

X164279			
	#	1	∅ 64
	442093		

X164280			
	#	1	∅ 64
	442093		

X164281			
	#	1	∅ 54

X164282			
	#	1	∅ 54

X164283			
	#	1	∅ 60
	442079		

X164284			
	#	1	∅ 60
	442079		

X164285			
	#	2	∅ 43
	441875		

X164286			
	#	2	∅ 43
	441875		

X164287			
	#	1	∅ 60
	442041		

X164288			
	#	1	∅ 60
	442041		

X164295			
	#	1	∅ 60
	441753		

X164296			
	#	1	∅ 60
	441753		



X164297				
	#	2	∅	48
	442461			

X164298				
	#	2	∅	48
	442461			

X164299				
	#	1	∅	60
	442328			

X164300				
	#	1	∅	60
	442328			

X164301				
	#	1	∅	57
	442075			

X164302				
	#	1	∅	57
	442075			

X164307				
	#	1	∅	63,5
	442398			

X164308				
	#	1	∅	63,5
	442398			

X164309				
	#	1	∅	60
	442079			

X164310				
	#	1	∅	60
	442079			

X164311				
	#	2	∅	38/43
	441641			

X164312				
	#	2	∅	38/43
	441641			



X164317				
	#	1	∅	57
	441609			

X164318				
	#	1	∅	57
	441609			



X164319				
	#	1	∅	57
	442075			



X164320				
	#	1	∅	57
	442075			







X164325				
	#	2	∅	43
				
				



X164326				
	#	2	∅	43
				
				



X165001				
	#	1	∅	38
				
				



X165002				
	#	1	∅	38
				
				



X165003				
	#	1	∅	32
				
	441600			

X165004				
	#	1	∅	32
				
	441600			

X165005				
	#	1	∅	30
				
	441761			



X165006				
	#	1	∅	30
				
	441761			



X165007				
	#	1	∅	30
				
	441761			

X165008				
	#	1	∅	30
				
	441761			

X165009				
	#	1	∅	38
				
				

X165010				
	#	1	∅	38
				
				



X165011				
	#	1	∅	35
				
	441760			



X165012				
	#	1	∅	35
				
	441760			



X165013				
	#	1	∅	35
				
				



X165014				
	#	1	∅	35
				
				





X165015			
	#	1	∅ 30
			
	441943		



X165016			
	#	1	∅ 30
			
	441943		



X165019			
	#	1	∅ 38
			
	441954		

X165020			
	#	1	∅ 38
			
	441954		

X165025			
	#	1	∅ 35
			
	441760		



X165026			
	#	1	∅ 35
			
	441760		



X165027			
	#	1	∅ 36
			
	442097		

X165028			
	#	1	∅ 36
			
	442097		

X165029			
	#	1	∅ 35
			
	442099		



X165030			
	#	1	∅ 35
			
	442099		



X165031			
	#	1	∅ 35
			
	442021		

X165032			
	#	1	∅ 35
			
	442021		



X165033			
	#	1	∅ 41
			
	441981		

X165034			
	#	1	∅ 41
			
	441981		

X165035			
	#	1	∅ 43
			
			



X165036			
	#	1	∅ 43
			
			





X165037			
	# 1	∅	38
			
			

X165038			
	# 1	∅	38
			
			



X165039			
	# 1	∅	30
			
	441988		

X165040			
	# 1	∅	30
			
	441988		

X165041			
	# 1	∅	38
			
			



X165042			
	# 1	∅	38
			
			



X165043			
	# 1	∅	30
			
	441761		

X165044			
	# 1	∅	30
			
	441761		

X165045			
	# 1	∅	35
			
			

X165046			
	# 1	∅	35
			
			

X165047			
	# 1	∅	30
			
	441989		

X165048			
	# 1	∅	30
			
	441989		



X165049			
	# 1	∅	43
			
	441911		



X165050			
	# 1	∅	43
			
	441911		

X165051			
	# 1	∅	35
			
	441874		



X165052			
	# 1	∅	35
			
	441874		









X165053			
	#	1	∅ 35
			
	441899		

X165054			
	#	1	∅ 35
			
	441899		

X165055			
	#	1	∅ 42
			
	441881		



X165056			
	#	1	∅ 42
			
	441881		



X165057			
	#	1	∅ 43
			
	442063		



X165058			
	#	1	∅ 43
			
	442063		

X165059			
	#	1	∅ 35
			
	441863		



X165060			
	#	1	∅ 35
			
	441863		



X165061			
	#	1	∅ 36
			
	441870		



X165062			
	#	1	∅ 36
			
	441870		



X165063			
	#	1	∅ 30
			
	441546		

X165064			
	#	1	∅ 30
			
	441546		

X165065			
	#	1	∅ 30
			
	441546		

X165066			
	#	1	∅ 30
			
	441546		

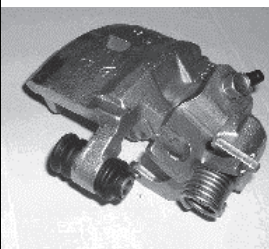
X165071			
	#	1	∅ 32
			
	441990		

X165072			
	#	1	∅ 32
			
	441990		



X165073			
	#	1	∅ 35
	441601		

X165074			
	#	1	∅ 35
	441601		

X165077			
	#	1	∅ 35
	441995		

X165078			
	#	1	∅ 35
	441995		

X165079			
	#	1	∅ 30

X165080			
	#	1	∅ 30

X165081			
	#	1	∅ 30
	441546		

X165082			
	#	1	∅ 30
	441546		

X165083			
	#	1	∅ 30
	441988		

X165084			
	#	1	∅ 30
	441988		

X165085			
	#	1	∅ 35
	441899		

X165086			
	#	1	∅ 35
	441899		

X165093			
	#	1	∅ 35
	442101		

X165094			
	#	1	∅ 35
	442101		

X165095			
	#	1	∅ 41
	441871		

X165096			
	#	1	∅ 41
	441871		



X165097				
	#	1	∅	43
				441956

X165098				
	#	1	∅	43
				441956

X165099				
	#	1	∅	35
				441955

X165100				
	#	1	∅	35
				441955

X165101				
	#	1	∅	38
				442024

X165102				
	#	1	∅	38
				442024

X165103				
	#	2	∅	38
				441858

X165104				
	#	2	∅	38
				441858

X165105				
	#	1	∅	43
				442005

X165106				
	#	1	∅	43
				442005

X165107				
	#	1	∅	38
				441882

X165108				
	#	1	∅	38
				441882



X165109				
	#	1	∅	35
				441883



X165110				
	#	1	∅	35
				441883

X165111				
	#	1	∅	30
				441943

X165112				
	#	1	∅	30
				441943



X165113			
	#	1	∅ 35
			
	442086		



X165114			
	#	1	∅ 35
			
	442086		



X165115			
	#	1	∅ 42
			
	441881		



X165116			
	#	1	∅ 42
			
	441881		



X165117			
	#	1	∅ 35
			
	441899		



X165118			
	#	1	∅ 35
			
	441899		



X165119			
	#	1	∅ 35
			
	441899		

X165120			
	#	1	∅ 35
			
	441899		

X165123			
	#	1	∅ 38
			
	441878		



X165124			
	#	1	∅ 38
			
	441878		



X165125			
	#	1	∅ 38
			
	442024		

X165126			
	#	1	∅ 38
			
	442024		



X165127			
	#	1	∅ 35
			
	441874		



X165128			
	#	1	∅ 35
			
	441874		

X165129			
	#	1	∅ 35
			
	442021		

X165130			
	#	1	∅ 35
			
	442021		



X165131			
	#	1	∅ 30
			
	441943		



X165132			
	#	1	∅ 30
			
	441943		

X165133			
	#	1	∅ 51
			
	441713		



X165134			
	#	1	∅ 51
			
	441713		



X165135			
	#	1	∅ 32
			
			



X165136			
	#	1	∅ 32
			
			



X165137			
	#	1	∅ 35
			
	441968		



X165138			
	#	1	∅ 35
			
	441968		



X165139			
	#	1	∅ 35
			
	442021		



X165140			
	#	1	∅ 35
			
	442021		

X165143			
	#	1	∅ 34
			
	442173		

X165144			
	#	1	∅ 34
			
	442173		



X165145			
	#	1	∅ 35
			
	442213		



X165146			
	#	1	∅ 35
			
	442213		



X165147			
	#	1	∅ 45
			
	442160		



X165148			
	#	1	∅ 45
			
	442160		







X165149			
	#	1	∅ 38
			
	441878		



X165150			
	#	1	∅ 38
			
	441878		



X165151			
	#	1	∅ 38
			
	441878		



X165152			
	#	1	∅ 38
			
	441878		



X165155			
	#	1	∅ 35
			
	442174		



X165156			
	#	1	∅ 35
			
	442174		



X165159			
	#	1	∅ 35
			
	442174		

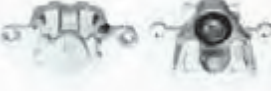

X165160			
	#	1	∅ 35
			
	442174		

X165161			
	#	1	∅ 38
			
	442228		

X165162			
	#	1	∅ 38
			
	442228		

X165165			
	#	1	∅ 38
			
	441878		

X165166			
	#	1	∅ 38
			
	441878		

X165167			
	#	1	∅ 38
			
	442211		

X165168			
	#	1	∅ 38
			
	442211		

X165169			
	#	1	∅ 38
			
	442211		

X165170			
	#	1	∅ 38
			
	442211		



X165171				
	#	1	∅	45
	442171			

X165172				
	#	1	∅	45
	442171			

X165173				
	#	1	∅	45
	442171			

X165174				
	#	1	∅	45
	442171			

X165175				
	#	1	∅	35
	442344			

X165176				
	#	1	∅	35
	442344			

X165181				
	#	1	∅	43
	442462			

X165182				
	#	1	∅	43
	442462			

X165191				
	#	1	∅	43
	441643			

X165192				
	#	1	∅	43
	441643			

X165193				
	#	1	∅	35
	441607			

X165194				
	#	1	∅	35
	441607			

X165195				
	#	1	∅	35
	442344			

X165196				
	#	1	∅	35
	442344			

X165197				
	#	1	∅	35
	441607			

X165198				
	#	1	∅	35
	441607			



X165199			
	# 1	∅ 30	
	441943		

X165200			
	# 1	∅ 30	
	441943		

X165201			
	# 1	∅ 42	
	442392		

X165202			
	# 1	∅ 42	
	442392		

X165203			
	# 1	∅ 43	
	441643		

X165204			
	# 1	∅ 43	
	441643		

X194001			
	# 2	∅ 48	

X194002			
	# 2	∅ 48	

X194005			
	# 1	∅ 60	
	441699		

X194006			
	# 1	∅ 60	
	441699		

X194011			
	# 1	∅ 60	

X194012			
	# 1	∅ 60	





X194013			
	# 2	∅ 48	



X194014			
	# 2	∅ 48	





X194015			
	# 2	∅ 44	



X194016			
	# 2	∅ 44	







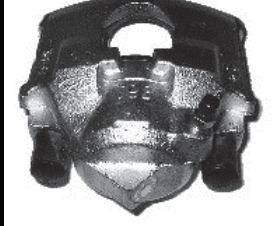

X194017				
	#	1	∅	60
				
				

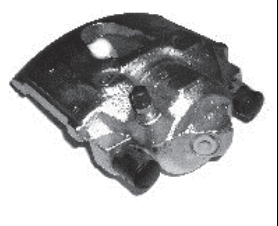

X194018				
	#	1	∅	60
				
				





X224001				
	#	1	∅	54
				
		441147		

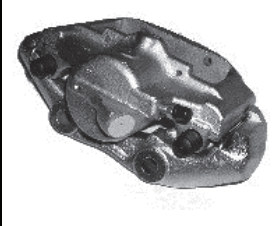



X224002				
	#	1	∅	54
				
		441147		





X224003				
	#	1	∅	54
				
		441147		

X224004				
	#	1	∅	54
				
		441147		



X224007				
	#	1	∅	48
				
				





X224008				
	#	1	∅	48
				
				





X224009				
	#	2	∅	48
				
		441185		





X224010				
	#	2	∅	48
				
		441185		





X224011				
	#	2	∅	42
				
		441190		

X224012				
	#	2	∅	42
				
		441190		



X224013				
	#	2	∅	40
				
		441689		



X224014				
	#	2	∅	40
				
		441689		

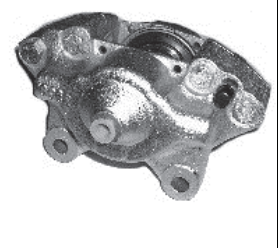

X224015				
	#	1	∅	48
				
		441162		



X224016				
	#	1	∅	48
				
		441162		



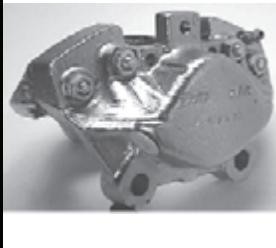



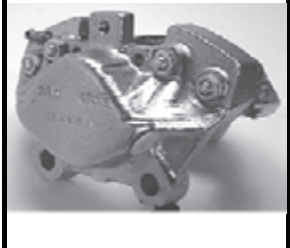

X224017			
	# 2	∅	48
			
	441131		



X224018			
	# 2	∅	48
			
	441131		



X224019			
	# 2	∅	48
			
	441185		



X224020			
	# 2	∅	48
			
	441185		



X224021			
	# 2	∅	54
			
	441926		

X224022			
	# 2	∅	54
			
	441926		

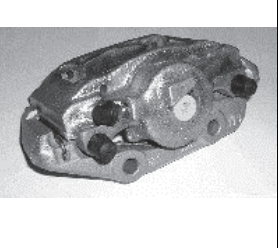
X224023			
	# 4	∅	40
			
	441215		

X224024			
	# 4	∅	40
			
	441215		

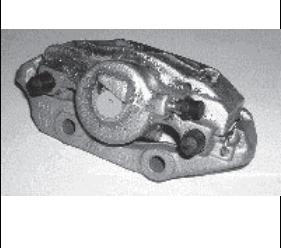

X224025			
	# 1	∅	48
			
	441912		



X224026			
	# 1	∅	48
			
	441912		



X224027			
	# 2	∅	44
			
	441271		

X224028			
	# 2	∅	44
			
	441271		



X224029			
	# 2	∅	48
			
	441185		

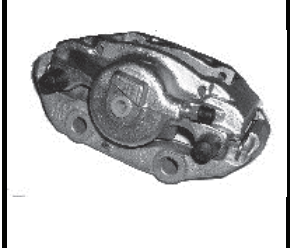

X224030			
	# 2	∅	48
			
	441185		

X224031			
	# 1	∅	48
			
	441912		

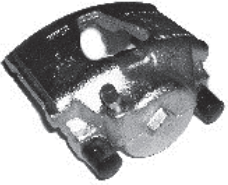
X224032			
	# 1	∅	48
			
	441912		







X224037			
	# 1	∅	54
			
	441147		

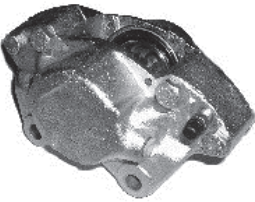

X224038			
	# 1	∅	54
			
	441147		

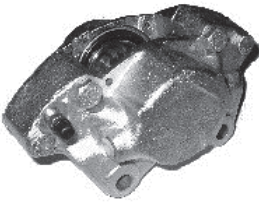

X224039			
	# 4	∅	34
			
	441860		



X224040			
	# 4	∅	34
			
	441860		

X224041			
	# 2	∅	54
			
	441143		



X224042			
	# 2	∅	54
			
	441143		



X224043			
	# 2	∅	54
			
	441143		



X224044			
	# 2	∅	54
			
	441143		

X224045			
	# 1	∅	52
			
	441644		



X224046			
	# 1	∅	52
			
	441644		



X224047			
	# 2	∅	48
			
	441185		

X224048			
	# 2	∅	48
			
	441185		

X224049			
	# 2	∅	45
			
	441685		

X224050			
	# 2	∅	45
			
	441685		

X224051			
	# 1	∅	57
			
	441476		

X224052			
	# 1	∅	57
			
	441476		



X224053				
	#	4	∅	36
	442071			

X224054				
	#	4	∅	36
	442071			

X224055				
	#	4	∅	36
	442071			

X224056				
	#	4	∅	36
	442071			

X224057				
	#	2	∅	57
	441347			

X224058				
	#	2	∅	57
	441347			

X224059				
	#	1	∅	52
	442124			

X224060				
	#	1	∅	52
	442124			

X224061				
	#	1	∅	60
	441221			

X224062				
	#	1	∅	60
	441221			

X224063				
	#	2	∅	42
	441190			

X224064				
	#	2	∅	42
	441190			

X224065				
	#	2	∅	54
	441428			

X224066				
	#	2	∅	54
	441428			

X224067				
	#	1	∅	44
	441428			

X224068				
	#	1	∅	44
	441428			

X224069				
	#	2	∅	40
	441689			

X224070				
	#	2	∅	40
	441689			

X224071				
	#	2	∅	54
	441926			

X224072				
	#	2	∅	54
	441926			

X224073				
	#	2	∅	57
	441347			

X224074				
	#	2	∅	57
	441347			

X224075				
	#	2	∅	42
	441190			

X224076				
	#	2	∅	42
	441190			

X224077				
	#	4	∅	40
	441215			

X224078				
	#	4	∅	40
	441215			

X224081				
	#	2	∅	60
	441357			

X224082				
	#	2	∅	60
	441357			

X224083				
	#	2	∅	54
	441926			

X224084				
	#	2	∅	54
	441926			

X224085				
	#	2	∅	54
	441926			

X224086				
	#	2	∅	54
	441926			



X224087				
	#	2	∅	48
	441185			

X224088				
	#	2	∅	48
	441185			

X224089				
	#	2	∅	48
	441209			

X224090				
	#	2	∅	48
	441209			

X224091				
	#	1	∅	44
	441165			

X224092				
	#	1	∅	44
	441165			

X224093				
	#	1	∅	48
	441150			

X224094				
	#	1	∅	48
	441150			

X224095				
	#	2	∅	48
	441185			

X224096				
	#	2	∅	48
	441185			

X224097				
	#	1	∅	60
	441221			

X224098				
	#	1	∅	60
	441221			

X224099				
	#	2	∅	48
	441185			

X224100				
	#	2	∅	48
	441185			

X224101				
	#	2	∅	44
	441271			

X224102				
	#	2	∅	44
	441271			



X224103			
	# 2	∅	48
	441185		

X224104			
	# 2	∅	48
	441185		

X224105			
	# 4	∅	40
	441215		

X224106			
	# 4	∅	40
	441215		

X224107			
	# 1	∅	48
	441150		

X224108			
	# 1	∅	48
	441150		

X224109			
	# 1	∅	54
	441156		

X224110			
	# 1	∅	54
	441156		

X224111			
	# 1	∅	44
	441165		

X224112			
	# 1	∅	44
	441165		

X224113			
	# 2	∅	57
	441654		

X224114			
	# 2	∅	57
	441654		



X224115			
	# 1	∅	44
	441165		



X224116			
	# 1	∅	44
	441165		



X224117			
	# 4	∅	40
	441215		



X224118			
	# 4	∅	40
	441215		









X224119			
	# 4	∅ 36	
			
	442071		



X224120			
	# 4	∅ 36	
			
	442071		



X224121			
	# 4	∅ 36	
			
	442071		



X224122			
	# 4	∅ 36	
			
	442071		



X224123			
	# 2	∅ 60	
			
	441357		



X224124			
	# 2	∅ 60	
			
	441357		

X224125			
	# 1	∅ 48	
			
	441150		

X224126			
	# 1	∅ 48	
			
	441150		



X224129			
	# 2	∅ 48	
			
	441185		



X224130			
	# 2	∅ 48	
			
	441185		



X224131			
	# 1	∅ 44	
			
			

X224132			
	# 1	∅ 44	
			
			

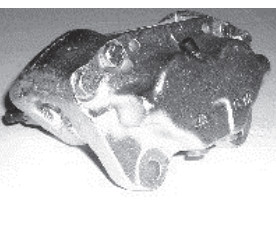

X224133			
	# 1	∅ 54	
			
			

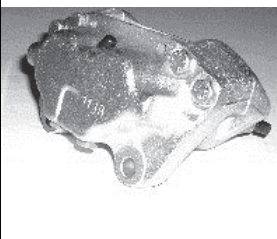

X224134			
	# 1	∅ 54	
			
			



X224135			
	# 4	∅ 40	
			
	441215		



X224136			
	# 4	∅ 40	
			
	441215		









X224137			
	# 4	∅	40
			
	441215		



X224138			
	# 4	∅	40
			
	441215		

X224139			
	# 1	∅	48
			
	441150		

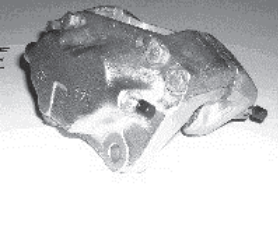

X224140			
	# 1	∅	48
			
	441150		

X224141			
	# 4	∅	40
			
	441215		

X224142			
	# 4	∅	40
			
	441215		

X224143			
	# 2	∅	60
			
	441357		



X224144			
	# 2	∅	60
			
	441357		



X224145			
	# 1	∅	54
			
	441156		

X224146			
	# 1	∅	54
			
	441156		

X224147			
	# 1	∅	54
			
	441195		

X224148			
	# 1	∅	54
			
	441195		

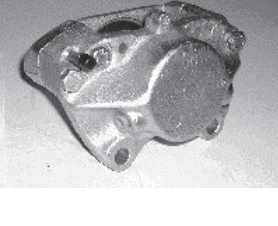
X224149			
	# 2	∅	60
			
	441357		

X224150			
	# 2	∅	60
			
	441357		

X224151			
	# 1	∅	52
			
	442124		

X224152			
	# 1	∅	52
			
	442124		



X224153				
	#	2	∅	60
	441357			

X224154				
	#	2	∅	60
	441357			

X224155				
	#	2	∅	54
	441428			

X224156				
	#	2	∅	54
	441428			

X224157				
	#	1	∅	54
	441147			

X224158				
	#	1	∅	54
	441147			

X224159				
	#	1	∅	57
	441476			

X224160				
	#	1	∅	57
	441476			

X224161				
	#	2	∅	48

X224162				
	#	2	∅	48

X224163				
	#	1	∅	54
	441195			

X224164				
	#	1	∅	54
	441195			

X224165				
	#	2	∅	57

X224166				
	#	2	∅	57
	441147			

X224167				
	#	1	∅	54
	441147			

X224168				
	#	1	∅	54
	441147			



X224169				
	#	1	∅	57
	441476			

X224170				
	#	1	∅	57
	441476			

X224171				
	#	1	∅	54
	441147			

X224172				
	#	1	∅	54
	441147			

X224175				
	#	1	∅	60
	441221			

X224176				
	#	1	∅	60
	441221			

X224177				
	#	2	∅	57
	441654			

X224178				
	#	2	∅	57
	441654			

X224179				
	#	1	∅	54
	441147			

X224180				
	#	1	∅	54
	441147			

X224181				
	#	1	∅	54
	441147			

X224182				
	#	1	∅	54
	441147			

X224183				
	#	2	∅	57
	441983			

X224184				
	#	2	∅	57
	441983			

X224185				
	#	4	∅	44
	441932			

X224186				
	#	4	∅	44
	441932			



X224187				
	#	4	∅	44
	441932			

X224188				
	#	4	∅	44
	441932			

X224189				
	#	1	∅	54

X224190				
	#	1	∅	54

X224191				
	#	1	∅	54
	441147			

X224192				
	#	1	∅	54
	441147			

X224193				
	#	1	∅	60
	441221			

X224194				
	#	1	∅	60
	441221			

X224195				
	#	1	∅	48
	441162			

X224196				
	#	1	∅	48
	441162			

X224199				
	#	1	∅	48
	441162			

X224200				
	#	1	∅	48
	441162			



X224201				
	#	1	∅	60



X224202				
	#	1	∅	60



X224205				
	#	1	∅	60
	441221			

X224206				
	#	1	∅	60
	441221			



X224207				
	#	1	∅	60
				
	441221			



X224208				
	#	1	∅	60
				
	441221			



X224209				
	#	1	∅	45
				
	441758			

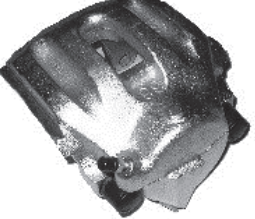

X224210				
	#	1	∅	45
				
	441758			

X224215				
	#	1	∅	48
				
	441162			

X224216				
	#	1	∅	48
				
	441162			

X224219				
	#	1	∅	60
				
	441221			



X224220				
	#	1	∅	60
				
	441221			



X224223				
	#	4	∅	38/42
				
	441939			



X224224				
	#	4	∅	38/42
				
	441939			



X224225				
	#	4	∅	40
				
	441215			

X224226				
	#	4	∅	40
				
	441215			

X224227				
	#	1	∅	57
				
	441476			

X224228				
	#	1	∅	57
				
	441476			

X224229				
	#	1	∅	48
				
	441162			

X224230				
	#	1	∅	48
				
	441162			



X224231			
	# 1	∅	48

X224232			
	# 1	∅	48

X224233			
	# 2	∅	48

X224234			
	# 2	∅	48

X224239			
	# 1	∅	57
	441476		

X224240			
	# 1	∅	57
	441476		

X224241			
	# 1	∅	57
	441476		

X224242			
	# 1	∅	57
	441476		

X224245			
	# 1	∅	45
	441172		

X224246			
	# 1	∅	45
	441172		

X224247			
	# 1	∅	48
	441162		

X224248			
	# 1	∅	48
	441162		



X224249			
	# 1	∅	54
	441147		

X224250			
	# 1	∅	54
	441147		

X224251			
	# 2	∅	57
	441654		

X224252			
	# 2	∅	57
	441654		





X224253				
	#	4	∅	42
				
	441939			

X224254				
	#	4	∅	42
				
	441939			

X224255				
	#	4	∅	42
				
	441939			



X224256				
	#	4	∅	42
				
	441939			



X224261				
	#	1	∅	54
				
	441147			



X224262				
	#	1	∅	54
				
	441147			



X224263				
	#	1	∅	54
				
	441147			



X224264				
	#	1	∅	54
				
	441147			



X224267				
	#	1	∅	60
				
	441221			



X224268				
	#	1	∅	60
				
	441221			



X224271				
	#	1	∅	60
				
	441528			

X224272				
	#	1	∅	60
				
	441528			



X224273				
	#	4	∅	38/42
				
	441939			

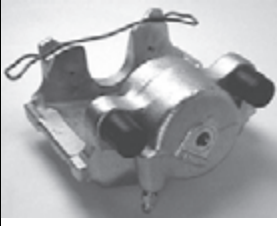

X224274				
	#	4	∅	38/42
				
	441939			

X224275				
	#	1	∅	54
				
	441147			

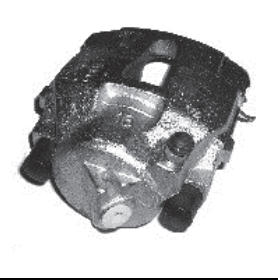
X224276				
	#	1	∅	54
				
	441147			



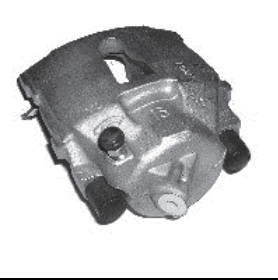

X224277			
	# 1	∅	60
			
			



X224278			
	# 1	∅	60
			
			



X224281			
	# 4	∅	44
			
	441932		

X224282			
	# 4	∅	44
			
	441932		



X224283			
	# 1	∅	54
			
	441147		

X224284			
	# 1	∅	54
			
	441147		

X224285			
	# 1	∅	54
			
	441147		



X224286			
	# 1	∅	54
			
	441147		



X224287			
	# 1	∅	48
			
	441162		



X224288			
	# 1	∅	48
			
	441162		



X224289			
	# 2	∅	60
			
	441357		

X224290			
	# 2	∅	60
			
	441357		

X224291			
	# 1	∅	60
			
	441221		

X224292			
	# 1	∅	60
			
	441221		

X224293			
	# 2	∅	60
			
	441357		

X224294			
	# 2	∅	60
			
	441357		



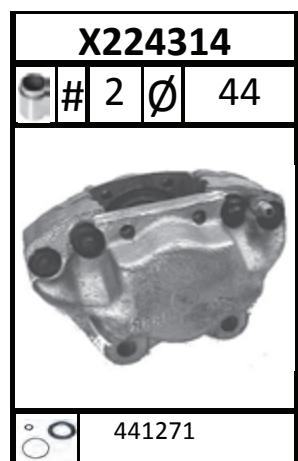
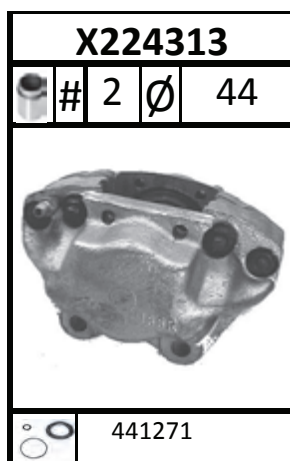
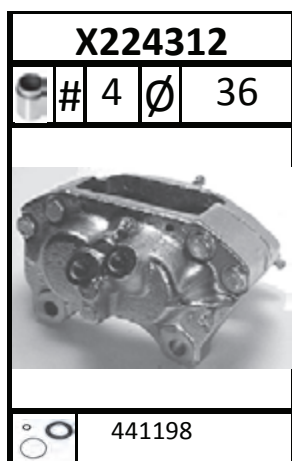
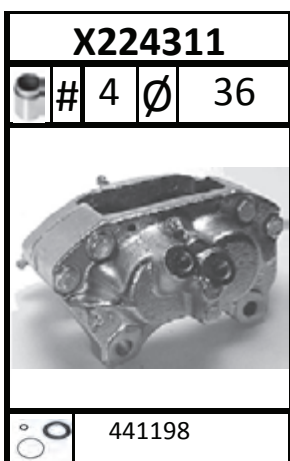
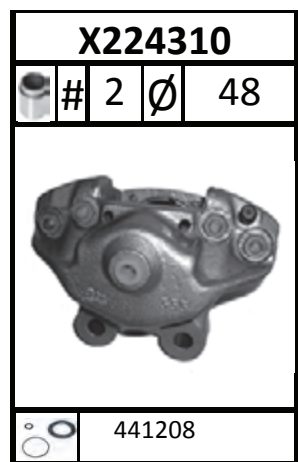
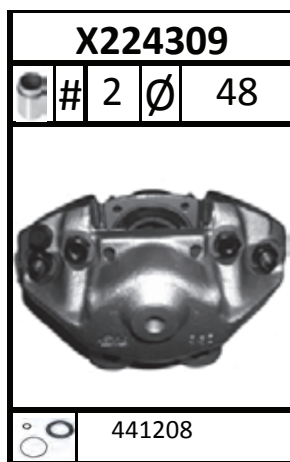
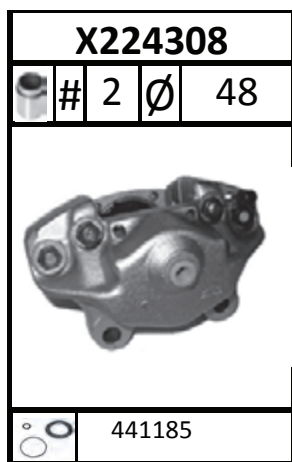
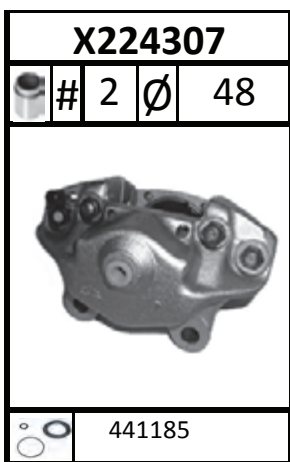
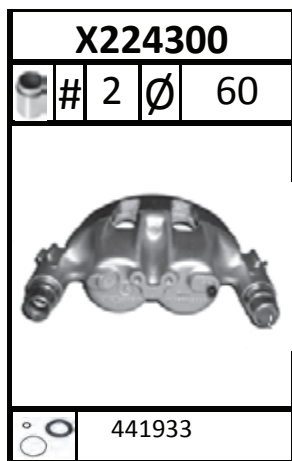
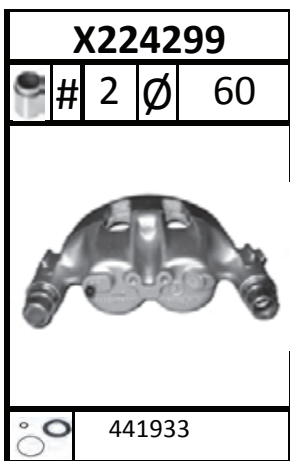
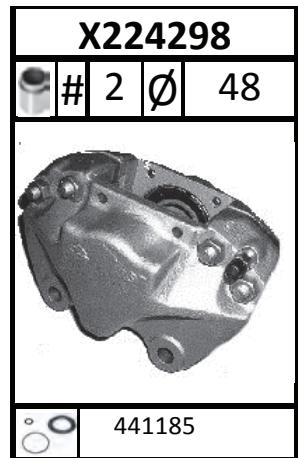
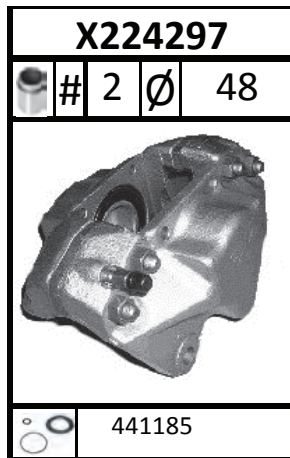
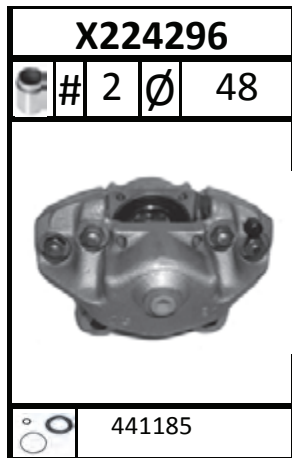

X224315				
	#	2	∅	38

X224316				
	#	2	∅	38

X224317				
	#	2	∅	57
	441347			

X224318				
	#	2	∅	57
	441347			

X224319				
	#	4	∅	40

X224320				
	#	4	∅	40

X224321				
	#	2	∅	48

X224322				
	#	2	∅	48

X224325				
	#	2	∅	48
	441185			

X224326				
	#	2	∅	48
	441185			

X224327				
	#	2	∅	45
	441685			

X224328				
	#	2	∅	45
	441685			

X224331				
	#	2	∅	48

X224332				
	#	2	∅	48

X224333				
	#	2	∅	54

X224334				
	#	2	∅	54



X224335				
	#	1	∅	48
	441912			

X224336				
	#	1	∅	48
	441912			

X224337				
	#	1	∅	48
	441150			

X224338				
	#	1	∅	48
	441150			

X224339				
	#	2	∅	48
	441185			

X224340				
	#	2	∅	48
	441185			

X224341				
	#	4	∅	34
	441213			

X224342				
	#	4	∅	34
	441213			

X224343				
	#	2	∅	54

X224344				
	#	2	∅	54

X224347				
	#	2	∅	48

X224348				
	#	2	∅	48

X224349				
	#	4	∅	34

X224350				
	#	4	∅	34

X224353				
	#	2	∅	54

X224354				
	#	2	∅	54



X224359				
	#	2	∅	57
	441347			

X224360				
	#	2	∅	57
	441347			

X224361				
	#	2	∅	48
	441185			

X224362				
	#	2	∅	48
	441185			

X224363				
	#	4	∅	34

X224364				
	#	4	∅	34

X224369				
	#	2	∅	48

X224370				
	#	2	∅	48

X224373				
	#	2	∅	48
	441185			

X224374				
	#	2	∅	48
	441185			

X224375				
	#	1	∅	44
	441165			

X224376				
	#	1	∅	44
	441165			

X224377				
	#	2	∅	42

X224378				
	#	2	∅	42

X224379				
	#	1	∅	48
	441150			

X224380				
	#	1	∅	48
	441150			



X224381				
	#	2	∅	54

X224382				
	#	2	∅	54

X224383				
	#	2	∅	48
				441185

X224384				
	#	2	∅	48
				441185

X224385				
	#	2	∅	54

X224386				
	#	2	∅	54

X224387				
	#	2	∅	42
				441190

X224388				
	#	2	∅	42
				441190

X224389				
	#	2	∅	42

X224390				
	#	2	∅	42

X224391				
	#	2	∅	38
				441218

X224392				
	#	2	∅	38
				441218

X224395				
	#	1	∅	48
				441912

X224396				
	#	1	∅	48
				441912

X224397				
	#	2	∅	60
				441357

X224398				
	#	2	∅	60
				441357



X224399				
	#	2	∅	54

X224400				
	#	2	∅	54

X224401				
	#	1	∅	48

X224402				
	#	1	∅	48

X224403				
	#	1	∅	48

X224404				
	#	1	∅	48

X224405				
	#	1	∅	48
	441150			

X224406				
	#	1	∅	48
	441150			

X224407				
	#	2	∅	48
	441185			

X224408				
	#	2	∅	48
	441185			

X224409				
	#	1	∅	48
	441150			

X224410				
	#	1	∅	48
	441150			



X224411				
	#	1	∅	54
	441156			



X224412				
	#	1	∅	54
	441156			



X224413				
	#	1	∅	54



X224414				
	#	1	∅	54



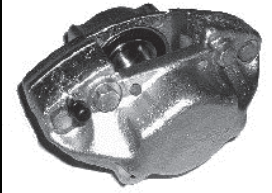



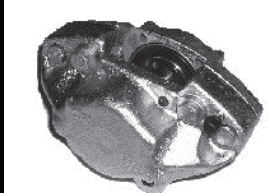

X224415			
	# 1	∅	54
			
	441147		



X224416			
	# 1	∅	54
			
	441147		



X224417			
	# 2	∅	48
			
	441185		



X224418			
	# 2	∅	48
			
	441185		

X224419			
	# 1	∅	54
			
	441147		

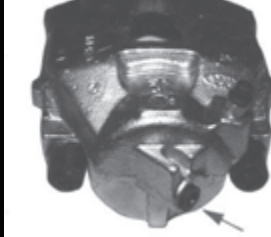

X224420			
	# 1	∅	54
			
	441147		



X224421			
	# 1	∅	60
			
	441221		

X224422			
	# 1	∅	60
			
	441221		



X224423			
	# 1	∅	60
			
	441221		

X224424			
	# 1	∅	60
			
	441221		

X224425			
	# 1	∅	54
			
	441147		

X224426			
	# 1	∅	54
			
	441147		

X224427			
	# 1	∅	54
			
	441147		

X224428			
	# 1	∅	54
			
	441147		

X224429			
	# 1	∅	57
			
	441476		

X224430			
	# 1	∅	57
			
	441476		



X224431				
	#	1	∅	54
	441147			

X224432				
	#	1	∅	54
	441147			

X224433				
	#	1	∅	57
	441476			

X224434				
	#	1	∅	57
	441476			

X224435				
	#	1	∅	57
	441476			

X224436				
	#	1	∅	57
	441476			

X224437				
	#	1	∅	57
	441476			

X224438				
	#	1	∅	57
	441476			

X224439				
	#	1	∅	57
	441476			

X224440				
	#	1	∅	57
	441476			

X224441				
	#	1	∅	60
	441221			

X224442				
	#	1	∅	60
	441221			



X224443				
	#	1	∅	60
	441849			



X224444				
	#	1	∅	60
	441849			

X224447				
	#	2	∅	57
	441654			



X224448				
	#	2	∅	57
	441654			









X224449			
	#	1	∅ 57
			
	441476		



X224450			
	#	1	∅ 57
			
	441476		

X224451			
	#	1	∅ 54
			
	441147		



X224452			
	#	1	∅ 54
			
	441147		



X224453			
	#	1	∅ 48
			
	441791		

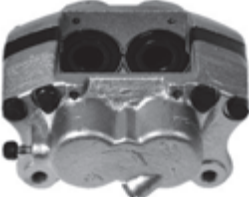

X224454			
	#	1	∅ 48
			
	441791		

X224455			
	#	1	∅ 54
			
	441147		

X224456			
	#	1	∅ 54
			
	441147		

X224457			
	#	4	∅ 40
			
	441215		

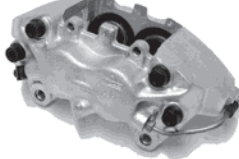

X224458			
	#	4	∅ 40
			
	441215		



X224459			
	#	4	∅ 40/44
			
			

X224460			
	#	4	∅ 40/44
			
			

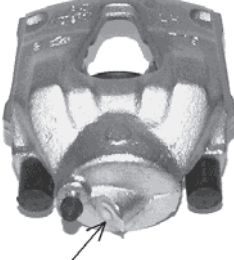

X224461			
	#	4	∅ 40/44
			
			

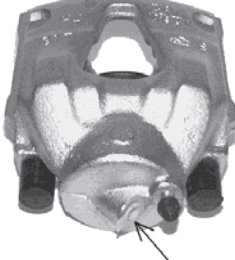

X224462			
	#	4	∅ 40/44
			
			



X224465			
	#	1	∅ 57
			
	441476		



X224466			
	#	1	∅ 57
			
	441476		



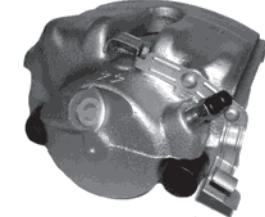

X224467			
	# 1	∅	60
			
	442080		

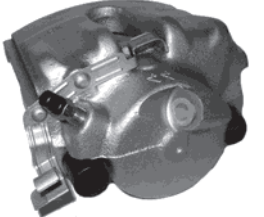
X224468			
	# 1	∅	60
			
	442080		

X224469			
	# 1	∅	60
			
	441221		



X224470			
	# 1	∅	60
			
	441221		



X224471			
	# 1	∅	57
			
	441476		



X224472			
	# 1	∅	57
			
	441476		



X224473			
	# 1	∅	54
			
	441825		

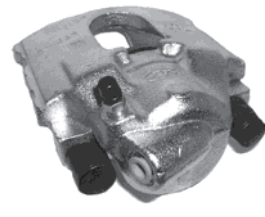

X224474			
	# 1	∅	54
			
	441825		



X224475			
	# 1	∅	54
			
	441147		



X224476			
	# 1	∅	54
			
	441147		



X224477			
	# 1	∅	54
			
	441147		

X224478			
	# 1	∅	54
			
	441147		

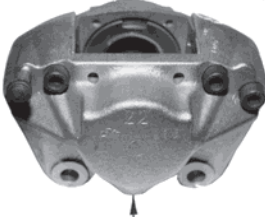
X224479			
	# 2	∅	57
			
	441654		

X224480			
	# 2	∅	57
			
	441654		

X224481			
	# 2	∅	57
			
	441347		

X224482			
	# 2	∅	57
			
	441347		



X224483				
	#	1	∅	57
	441476			

X224484				
	#	1	∅	57
	441476			

X224485				
	#	1	∅	57
	441476			

X224486				
	#	1	∅	57
	441476			

X224487				
	#	1	∅	60
	441221			

X224488				
	#	1	∅	60
	441221			

X224489				
	#	1	∅	60
	441221			

X224490				
	#	1	∅	60
	441221			

X224491				
	#	1	∅	60
	441221			

X224492				
	#	1	∅	60
	441221			

X224493				
	#	1	∅	48

X224494				
	#	1	∅	48



X224495				
	#	1	∅	54
	441825			

X224496				
	#	1	∅	54
	441825			



X224497				
	#	2	∅	54



X224498				
	#	2	∅	54



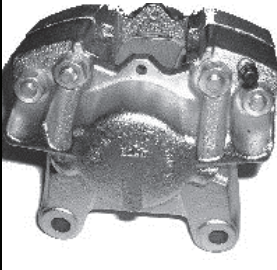

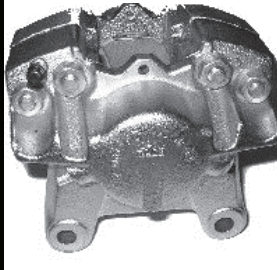

X224499			
	#	2	∅ 42
			
	442165		

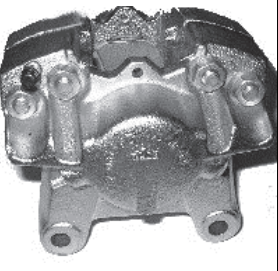

X224500			
	#	2	∅ 42
			
	442165		

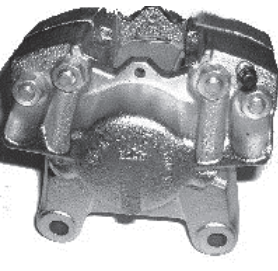

X224501			
	#	2	∅ 48
			
			



X224502			
	#	2	∅ 48
			
			



X224503			
	#	2	∅ 48
			
			



X224504			
	#	2	∅ 48
			
			



X224507			
	#	2	∅ 48
			
			



X224508			
	#	2	∅ 48
			
			



X224509			
	#	2	∅ 48
			
			

X224510			
	#	2	∅ 48
			
			

X224511			
	#	4	∅ 40
			
			

X224512			
	#	4	∅ 40
			
			

X224513			
	#	2	∅ 48
			
			

X224514			
	#	2	∅ 48
			
			

X224515			
	#	2	∅ 57
			
			

X224516			
	#	2	∅ 57
			
			



X224517				
	#	1	∅	60
		441221		

X224518				
	#	1	∅	60
		441221		

X224521				
	#	1	∅	57
		441476		

X224522				
	#	1	∅	57
		441476		

X224527				
	#	1	∅	48
		442036		

X224528				
	#	1	∅	48
		442036		

X224529				
	#	1	∅	52
		441967		

X224530				
	#	1	∅	52
		441967		

X224531				
	#	1	∅	54
		441147		

X224532				
	#	1	∅	54
		441147		

X224533				
	#	1	∅	48
		441162		

X224534				
	#	1	∅	48
		441162		

X224535				
	#	2	∅	48

X224536				
	#	2	∅	48

X224543				
	#	1	∅	48
		441162		

X224544				
	#	1	∅	48
		441162		



X224545				
	#	1	∅	54
	441147			

X224546				
	#	1	∅	54
	441147			

X224547				
	#	1	∅	57
	442030			

X224548				
	#	1	∅	57
	442030			

X224555				
	#	1	∅	57
	442030			

X224556				
	#	1	∅	57
	442030			

X224559				
	#	1	∅	57
	442153			

X224560				
	#	1	∅	57
	442153			

X224563				
	#	1	∅	60
	441849			

X224564				
	#	1	∅	60
	441849			

X224565				
	#	1	∅	60
	441849			

X224566				
	#	1	∅	60
	441849			

X224571				
	#	1	∅	48
	442036			

X224572				
	#	1	∅	48
	442036			

X224573				
	#	1	∅	54
	441825			

X224574				
	#	1	∅	54
	441825			



X224579			
	# 1	∅	57
	441476		

X224580			
	# 1	∅	57
	441476		

X224581			
	# 1	∅	48
	442036		

X224582			
	# 1	∅	48
	442036		

X224591			
	# 1	∅	57
	442030		

X224592			
	# 1	∅	57
	442030		

X224593			
	# 1	∅	66
	442246		

X224594			
	# 1	∅	66
	442246		

X224597			
	# 1	∅	54
	441147		

X224598			
	# 1	∅	54
	441147		

X224601			
	# 1	∅	57
	442030		

X224602			
	# 1	∅	57
	442030		

X224603			
	# 1	∅	57
	441476		

X224604			
	# 1	∅	57
	441476		

X224605			
	# 1	∅	54
	441825		

X224606			
	# 1	∅	54
	441825		



X224607			
	# 2	∅	48
	442319		

X224608			
	# 2	∅	48
	442319		

X224617			
	# 1	∅	57
	442030		

X224618			
	# 1	∅	57
	442030		

X224619			
	# 1	∅	54
	441825		

X224620			
	# 1	∅	54
	441825		

X224625			
	# 1	∅	57
	442030		

X224626			
	# 1	∅	57
	442030		

X224627			
	# 1	∅	60
	442134		

X224628			
	# 1	∅	60
	442134		

X224629			
	# 1	∅	60
	441849		

X224630			
	# 1	∅	60
	441849		



X224631			
	# -	∅	48
	442036		



X224632			
	# -	∅	48
	442036		



X224633			
	# 1	∅	57
	442178		

X224634			
	# 1	∅	57
	442178		









X224635				
	#	1	∅	57
				
	442030			

X224636				
	#	1	∅	57
				
	442030			

X224637				
	#	1	∅	60
				
	442180			



X224638				
	#	1	∅	60
				
	442180			



X224645				
	#	2	∅	42
				
	442181			



X224646				
	#	2	∅	42
				
	442181			

X224647				
	#	1	∅	54
				
	441825			



X224648				
	#	1	∅	54
				
	441825			



X224651				
	#	1	∅	60
				
	441849			



X224652				
	#	1	∅	60
				
	441849			



X224653				
	#	1	∅	57
				
	442030			

X224654				
	#	1	∅	57
				
	442030			



X224655				
	#	1	∅	57
				
	442030			



X224656				
	#	1	∅	57
				
	442030			



X224659				
	#	1	∅	54
				
	441825			



X224660				
	#	1	∅	54
				
	441825			









X224663			
	# 1	∅	60
			
	441849		



X224664			
	# 1	∅	60
			
	441849		

X224665			
	# 1	∅	60
			
	441849		



X224666			
	# 1	∅	60
			
	441849		



X224667			
	# 4	∅	38/42
			
	441939		

X224668			
	# 4	∅	38/42
			
	441939		



X224675			
	# 1	∅	54
			
	441825		



X224676			
	# 1	∅	54
			
	441825		



X224677			
	# 1	∅	66
			
	442242		

X224678			
	# 1	∅	66
			
	442242		



X224679			
	# 2	∅	44
			
	441561		

X224680			
	# 2	∅	44
			
	441561		

X224683			
	# 1	∅	57
			
	442030		

X224684			
	# 1	∅	57
			
	442030		



X224685			
	# 1	∅	60
			
	441849		



X224686			
	# 1	∅	60
			
	441849		



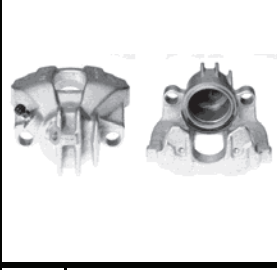



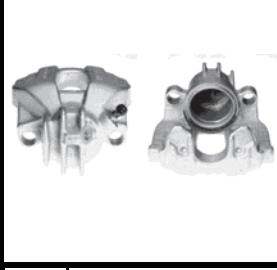

X224687			
	#	1	∅ 60
			
			



X224688			
	#	1	∅ 60
			
			



X224689			
	#	1	∅ 57
			
	442030		



X224690			
	#	1	∅ 57
			
	442030		



X224691			
	#	1	∅ 60
			
	442180		



X224692			
	#	1	∅ 60
			
	442180		



X224693			
	#	1	∅ 57
			
	442030		



X224694			
	#	1	∅ 57
			
	442030		



X224695			
	#	1	∅ 60
			
	442180		



X224696			
	#	1	∅ 60
			
	442180		



X224697			
	#	1	∅ 60
			
	442180		

X224698			
	#	1	∅ 60
			
	442180		

X224699			
	#	1	∅ 57
			
	442030		

X224700			
	#	1	∅ 57
			
	442030		

X224701			
	#	1	∅ 57
			
	442030		

X224702			
	#	1	∅ 57
			
	442030		



X224703			
	# 1	∅	60
	441849		

X224704			
	# 1	∅	60
	441849		

X224707			
	# 1	∅	60
	441849		

X224708			
	# 1	∅	60
	441849		

X224711			
	# 1	∅	54
	441825		

X224712			
	# 1	∅	54
	441825		

X224713			
	# 1	∅	60
	441849		

X224714			
	# 1	∅	60
	441849		

X224715			
	# 1	∅	60
	441849		

X224716			
	# 1	∅	60
	441849		

X224719			
	# 2	∅	54

X224720			
	# 2	∅	54

X224721			
	# 1	∅	60
	442134		

X224722			
	# 1	∅	60
	442134		

X224725			
	# 1	∅	57
	442030		

X224726			
	# 1	∅	57
	442030		



X224727				
	#	1	∅	54
	441825			

X224728				
	#	1	∅	54
	441825			

X224737				
	#	2	∅	42
	441221			

X224738				
	#	2	∅	42
	441221			

X224739				
	#	1	∅	57
	441471			

X224740				
	#	1	∅	57
	441471			

X224743				
	#	1	∅	66
	441622			

X224744				
	#	1	∅	66
	441622			

X224745				
	#	1	∅	57
	442030			

X224746				
	#	1	∅	57
	442030			

X224749				
	#	1	∅	60
	441849			

X224750				
	#	1	∅	60
	441849			

X224751				
	#	1	∅	60
	441849			

X224752				
	#	1	∅	60
	441849			

X224753				
	#	1	∅	57
	442030			

X224754				
	#	1	∅	57
	442030			



X224759				
	#	1	∅	57
	442030			

X224760				
	#	1	∅	57
	442030			

X224763				
	#	1	∅	57
	442030			

X224764				
	#	1	∅	57
	442030			

X224765				
	#	1	∅	60
	441849			

X224766				
	#	1	∅	60
	441849			

X224767				
	#	1	∅	60
	442180			

X224768				
	#	1	∅	60
	442180			

X224769				
	#	1	∅	60
	441849			

X224770				
	#	1	∅	60
	441849			

X224771				
	#	1	∅	60
	441849			

X224772				
	#	1	∅	60
	441849			

X224773				
	#	1	∅	60
	441556			

X224774				
	#	1	∅	60
	441556			

X224775				
	#	2	∅	44
	441561			

X224776				
	#	2	∅	44
	441561			



X224785			
	# 1	∅	57
	442030		

X224786			
	# 1	∅	57
	442030		

X224791			
	# 1	∅	54
	441825		

X224792			
	# 1	∅	54
	441825		

X224793			
	# 1	∅	60
	441343		

X224794			
	# 1	∅	60
	441343		

X224797			
	# 1	∅	57
	442030		

X224798			
	# 1	∅	57
	442030		

X224799			
	# 2	∅	42
	442165		

X224800			
	# 2	∅	42
	442165		

X224803			
	# 1	∅	54
	441825		

X224804			
	# 1	∅	54
	441825		

X224805			
	# 1	∅	57
	442030		

X224806			
	# 1	∅	57
	442030		

X224811			
	# 1	∅	60
	441849		

X224812			
	# 1	∅	60
	441849		



X224813				
	#	2	∅	42

X224814				
	#	2	∅	42

X224817				
	#	1	∅	54
	441825			

X224818				
	#	1	∅	54
	441825			

X224819				
	#	1	∅	57
	442030			

X224820				
	#	1	∅	57
	442030			

X224821				
	#	1	∅	57
	442030			

X224822				
	#	1	∅	57
	442030			

X224823				
	#	2	∅	42
	441562			

X224824				
	#	2	∅	42
	441562			

X224833				
	#	1	∅	57
	441476			

X224834				
	#	1	∅	57
	441476			

X224837				
	#	1	∅	57
	442030			

X224838				
	#	1	∅	57
	442030			

X224847				
	#	1	∅	54
	441770			

X224848				
	#	1	∅	54
	441770			



X224849			
	# 1	∅	60
	441221		

X224850			
	# 1	∅	60
	441221		

X224851			
	# 1	∅	57
	442030		

X224852			
	# 1	∅	57
	442030		

X224853			
	# 1	∅	57
	442030		

X224854			
	# 1	∅	57
	442030		

X224855			
	# 1	∅	54
	441825		

X224856			
	# 1	∅	54
	441825		

X224857			
	# 2	∅	42
	441562		

X224858			
	# 2	∅	42
	441562		

X224863			
	# 1	∅	60

X224864			
	# 1	∅	60

X224875			
	# 2	∅	44
	441561		

X224876			
	# 2	∅	44
	441561		

X224877			
	# 1	∅	48
	442036		

X224878			
	# 1	∅	48
	442036		



X224885				
	#	2	∅	44

X224886				
	#	2	∅	44

X224887				
	#	1	∅	60
	441849			

X224888				
	#	1	∅	60
	441849			

X224889				
	#	1	∅	60

X224890				
	#	1	∅	60

X224903				
	#	1	∅	60

X224904				
	#	1	∅	60

X224907				
	#	1	∅	60

X224908				
	#	1	∅	60

X225001				
	#	1	∅	33
	441212			

X225002				
	#	1	∅	33
	441212			

X225003				
	#	2	∅	38
	441218			

X225004				
	#	2	∅	38
	441218			

X225005				
	#	2	∅	27

X225006				
	#	2	∅	27

X225007				
	#	2	∅	42
	441190			

X225008				
	#	2	∅	42
	441190			

X225009				
	#	2	∅	38
	441188			

X225010				
	#	2	∅	38
	441188			

X225011				
	#	1	∅	33
	441212			

X225012				
	#	1	∅	33
	441212			

X225013				
	#	1	∅	36
	441204			

X225014				
	#	1	∅	36
	441204			

X225015				
	#	2	∅	36
	441658			

X225016				
	#	2	∅	36
	441658			

X225019				
	#	2	∅	42
	441190			

X225020				
	#	2	∅	42
	441190			



X225021				
	#	2	∅	38
	441218			



X225022				
	#	2	∅	38
	441218			



X225023				
	#	2	∅	38
	441648			



X225024				
	#	2	∅	38
	441648			









X225025				
	#	2	∅	35
				
	441817			



X225026				
	#	2	∅	35
				
	441817			

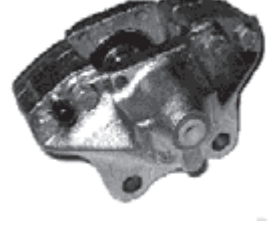

X225027				
	#	2	∅	35
				
	441817			



X225028				
	#	2	∅	35
				
	441817			



X225029				
	#	2	∅	30
				
	441586			



X225030				
	#	2	∅	30
				
	441586			



X225031				
	#	2	∅	33
				
	441193			



X225032				
	#	2	∅	33
				
	441193			

X225033				
	#	2	∅	42
				
	441190			

X225034				
	#	2	∅	42
				
	441190			



X225035				
	#	2	∅	38
				
	441218			

X225036				
	#	2	∅	38
				
	441218			



X225037				
	#	2	∅	40
				
	441689			



X225038				
	#	2	∅	40
				
	441689			



X225039				
	#	2	∅	38
				
	441218			



X225040				
	#	2	∅	38
				
	441218			









X225041			
	# 1	∅	33
			
			



X225042			
	# 1	∅	33
			
			



X225043			
	# 2	∅	33
			
	441193		



X225044			
	# 2	∅	33
			
	441193		



X225045			
	# 2	∅	38
			
	441218		



X225046			
	# 2	∅	38
			
	441218		

X225047			
	# 1	∅	33
			
	441212		



X225048			
	# 1	∅	33
			
	441212		



X225049			
	# 2	∅	38
			
	441218		



X225050			
	# 2	∅	38
			
	441218		

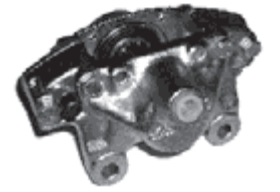

X225051			
	# 2	∅	38
			
			

X225052			
	# 2	∅	38
			
			

X225053			
	# 2	∅	35
			
	441261		

X225054			
	# 2	∅	35
			
	441261		

X225057			
	# 2	∅	40
			
	441689		

X225058			
	# 2	∅	40
			
	441689		



X225059				
	#	2	∅	38
	441218			

X225060				
	#	2	∅	38
	441218			

X225061				
	#	1	∅	38
	441642			

X225062				
	#	1	∅	38
	441642			

X225065				
	#	2	∅	40
	442034			

X225066				
	#	2	∅	40
	442034			

X225067				
	#	2	∅	40
	441689			

X225068				
	#	2	∅	40
	441689			

X225069				
	#	2	∅	35
	441817			

X225070				
	#	2	∅	35
	441817			

X225071				
	#	2	∅	38
	441218			

X225072				
	#	2	∅	38
	441218			



X225073				
	#	2	∅	33
	441193			



X225074				
	#	2	∅	33
	441193			



X225075				
	#	2	∅	40
	442034			

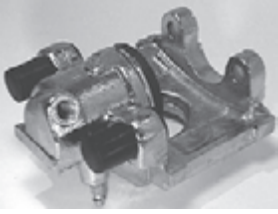

X225076				
	#	2	∅	40
	442034			









X225077			
	# 1	∅	38
			
	442023		



X225078			
	# 1	∅	38
			
	442023		

X225079			
	# 2	∅	35
			
	441817		



X225080			
	# 2	∅	35
			
	441817		



X225081			
	# 1	∅	40
			
	441928		



X225082			
	# 1	∅	40
			
	441928		



X225085			
	# 2	∅	42
			
	441190		

X225086			
	# 2	∅	42
			
	441190		

X225087			
	# 1	∅	33
			
	441521		



X225088			
	# 1	∅	33
			
	441521		



X225091			
	# 2	∅	40
			
	442034		

X225092			
	# 2	∅	40
			
	442034		

X225093			
	# 1	∅	40
			
	442068		

X225094			
	# 1	∅	40
			
	442068		

X225095			
	# 1	∅	38
			
	442023		

X225096			
	# 1	∅	38
			
	442023		









X225097			
	#	1	∅ 35
			
	442087		

X225098			
	#	1	∅ 35
			
	442087		

X225099			
	#	1	∅ 40
			
	441928		

X225100			
	#	1	∅ 40
			
	441928		

X225101			
	#	1	∅ 40
			
	441928		



X225102			
	#	1	∅ 40
			
	441928		



X225103			
	#	1	∅ 35
			
	442087		



X225104			
	#	1	∅ 35
			
	442087		



X225105			
	#	1	∅ 34
			
	441927		



X225106			
	#	1	∅ 34
			
	441927		



X225107			
	#	1	∅ 36
			
	441916		

X225108			
	#	1	∅ 36
			
	441916		

X225113			
	#	2	∅ 40
			
	442034		

X225114			
	#	2	∅ 40
			
	442034		

X225115			
	#	2	∅ 33
			
	441769		

X225116			
	#	2	∅ 33
			
	441769		



X225119				
	#	2	∅	34
	441944			

X225120				
	#	2	∅	34
	441944			

X225121				
	#	2	∅	38
	441218			

X225122				
	#	2	∅	38
	441218			

X225123				
	#	2	∅	42
	441190			

X225124				
	#	2	∅	42
	441190			

X225125				
	#	2	∅	35
	441378			

X225126				
	#	2	∅	35
	441378			

X225127				
	#	2	∅	38
	441218			

X225128				
	#	2	∅	38
	441218			

X225129				
	#	1	∅	36
	442112			

X225130				
	#	1	∅	36
	442112			

X225133				
	#	1	∅	52
	441644			

X225134				
	#	1	∅	52
	441644			

X225137				
	#	2	∅	33
	441193			

X225138				
	#	2	∅	33
	441193			



X225139				
	#	2	∅	42
	441190			

X225140				
	#	2	∅	42
	441190			

X225143				
	#	2	∅	42

X225144				
	#	2	∅	42

X225145				
	#	2	∅	42

X225146				
	#	2	∅	42

X225147				
	#	2	∅	38

X225148				
	#	2	∅	38

X225149				
	#	2	∅	30

X225150				
	#	2	∅	30

X225151				
	#	1	∅	27

X225152				
	#	1	∅	27

X225153				
	#	2	∅	42

X225154				
	#	2	∅	42

X225155				
	#	1	∅	36
	442112			

X225156				
	#	1	∅	36
	442112			



X225157				
	#	2	∅	54
	442236			

X225158				
	#	2	∅	54
	442236			

X225159				
	#	1	∅	33
	441521			

X225160				
	#	1	∅	33
	441521			

X225161				
	#	1	∅	36
	441916			

X225162				
	#	1	∅	36
	441916			

X225163				
	#	2	∅	35
	441817			

X225164				
	#	2	∅	35
	441817			

X225167				
	#	1	∅	40
	441848			

X225168				
	#	1	∅	40
	441848			

X225169				
	#	1	∅	40
	441848			

X225170				
	#	1	∅	40
	441848			



X225171				
	#	1	∅	40
	441928			



X225172				
	#	1	∅	40
	441928			



X225173				
	#	1	∅	38
	441642			

X225174				
	#	1	∅	38
	441642			









X225175			
	# 1	∅	38
			
	441642		

X225176			
	# 1	∅	38
			
	441642		



X225177			
	# 1	∅	34
			
	441927		

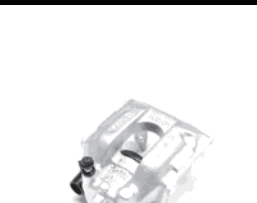

X225178			
	# 1	∅	34
			
	441927		



X225179			
	# 1	∅	40
			
	442068		



X225180			
	# 1	∅	40
			
	442068		



X225183			
	# 1	∅	33
			
	441521		



X225184			
	# 1	∅	33
			
	441521		



X225185			
	# 1	∅	36
			
	441916		

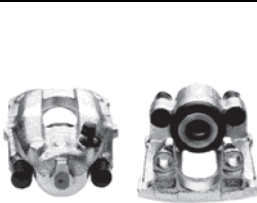

X225186			
	# 1	∅	36
			
	441916		

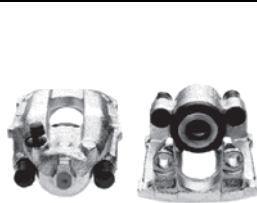

X225187			
	# 2	∅	38
			
	441648		

X225188			
	# 2	∅	38
			
	441648		

X225189			
	# 1	∅	40
			
	442068		

X225190			
	# 1	∅	40
			
	442068		

X225191			
	# 2	∅	38
			
	441218		

X225192			
	# 2	∅	38
			
	441218		



X225193				
	#	2	∅	38

X225194				
	#	2	∅	38

X225195				
	#	2	∅	52

X225196				
	#	2	∅	52

X225199				
	#	2	∅	38

X225200				
	#	2	∅	38

X225201				
	#	2	∅	38

X225202				
	#	2	∅	38

X225203				
	#	2	∅	35

X225204				
	#	2	∅	35

X225205				
	#	2	∅	33

X225206				
	#	2	∅	33

X225207				
	#	4	∅	34

X225208				
	#	4	∅	34

X225209				
	#	1	∅	40
				441928

X225210				
	#	1	∅	40
				441928



X225211			
	#	1	∅ 45
	441966		

X225212			
	#	1	∅ 45
	441966		

X225213			
	#	1	∅ 36

X225214			
	#	1	∅ 36

X225215			
	#	4	∅ 48/57

X225216			
	#	4	∅ 48/57

X225217			
	#	1	∅ 40
	441928		

X225218			
	#	1	∅ 40
	441928		

X225219			
	#	2	∅ 35
	442032		

X225220			
	#	2	∅ 35
	442032		

X225221			
	#	2	∅ 36
	441817		

X225222			
	#	2	∅ 36
	441817		

X225223			
	#	2	∅ 36
	442032		

X225224			
	#	2	∅ 36
	442032		

X225231			
	#	1	∅ 48
	442036		

X225232			
	#	1	∅ 48
	442036		



X225233				
	#	2	∅	42
	441997			

X225234				
	#	2	∅	42
	441997			

X225245				
	#	1	∅	38
	442048			

X225246				
	#	1	∅	38
	442048			

X225247				
	#	1	∅	42
	442133			

X225248				
	#	1	∅	42
	442133			

X225249				
	#	2	∅	36
	442032			

X225250				
	#	2	∅	36
	442032			

X225251				
	#	2	∅	46
	441980			

X225252				
	#	2	∅	46
	441980			

X225253				
	#	1	∅	36
	441916			

X225254				
	#	1	∅	36
	441916			

X225265				
	#	1	∅	42
	442007			



X225266				
	#	1	∅	42
	442007			

X225267				
	#	1	∅	36
	441916			

X225268				
	#	1	∅	36
	441916			





X225269			
	#	1	∅ 38
			
	441642		



X225270			
	#	1	∅ 38
			
	441642		



X225271			
	#	1	∅ 42
			
	442007		



X225272			
	#	1	∅ 42
			
	442007		

X225273			
	#	1	∅ 34
			
	442147		

X225274			
	#	1	∅ 34
			
	442147		

X225275			
	#	2	∅ 35
			
	442032		



X225276			
	#	2	∅ 35
			
	442032		



X225277			
	#	1	∅ 38
			
	442048		

X225278			
	#	1	∅ 38
			
	442048		

X225281			
	#	1	∅ 38
			
	442048		

X225282			
	#	1	∅ 38
			
	442048		

X225283			
	#	1	∅ 42
			
	442007		

X225284			
	#	1	∅ 42
			
	442007		

X225285			
	#	1	∅ 38
			
	442048		

X225286			
	#	1	∅ 38
			
	442048		



X225287			
	# 2	∅ 36	
	442032		

X225288			
	# 2	∅ 36	
	442032		

X225289			
	# 2	∅ 36	
	441658		

X225290			
	# 2	∅ 36	
	441658		

X225291			
	# 2	∅ 38	
	441218		

X225292			
	# 2	∅ 38	
	441218		

X225293			
	# 2	∅ 40	
	442034		

X225294			
	# 2	∅ 40	
	442034		

X225295			
	# 2	∅ 40	
	442034		

X225296			
	# 2	∅ 40	
	442034		

X225301			
	# 1	∅ 36	
	442169		

X225302			
	# 1	∅ 36	
	442169		

X225303			
	# 1	∅ 38	
	442048		

X225304			
	# 1	∅ 38	
	442048		

X225307			
	# 1	∅ 42	
	442166		

X225308			
	# 1	∅ 42	
	442166		



X225309			
	# 1	∅	46
	442190		

X225310			
	# 1	∅	46
	442190		

X225311			
	# 1	∅	42
	442007		

X225312			
	# 1	∅	42
	442007		

X225313			
	# 2	∅	36
	442032		

X225314			
	# 2	∅	36
	442032		

X225315			
	# 1	∅	34
	442147		

X225316			
	# 1	∅	34
	442147		

X225321			
	# 1	∅	44
	442146		

X225322			
	# 1	∅	44
	442146		

X225323			
	# 1	∅	42
	442007		

X225324			
	# 1	∅	42
	442007		

X225325			
	# 1	∅	44
	442146		

X225326			
	# 1	∅	44
	442146		

X225329			
	# 1	∅	34
	441475		

X225330			
	# 1	∅	34
	441475		



X225331				
	#	1	∅	42
	442007			

X225332				
	#	1	∅	42
	442007			

X225335				
	#	1	∅	40
	441848			

X225336				
	#	1	∅	40
	441848			

X225337				
	#	1	∅	40
	441532			

X225338				
	#	1	∅	40
	441532			

X225339				
	#	1	∅	40
	441532			

X225340				
	#	1	∅	40
	441532			

X225345				
	#	1	∅	45
	441613			

X225346				
	#	1	∅	45
	441613			

X225347				
	#	1	∅	40
	441848			

X225348				
	#	1	∅	40
	441848			

X225349				
	#	1	∅	38
	442048			

X225350				
	#	1	∅	38
	442048			

X225351				
	#	1	∅	42
	442007			

X225352				
	#	1	∅	42
	442007			



X225353				
	#	1	∅	44
	442146			

X225354				
	#	1	∅	44
	442146			

X225357				
	#	1	∅	40
	441928			

X225358				
	#	1	∅	40
	441928			

X225359				
	#	1	∅	42
	442166			

X225360				
	#	1	∅	42
	442166			

X225361				
	#	1	∅	40
	441848			

X225362				
	#	1	∅	40
	441848			

X225363				
	#	1	∅	46
	442190			

X225364				
	#	1	∅	46
	442190			

X225365				
	#	1	∅	42
	442166			

X225366				
	#	1	∅	42
	442166			

X225367				
	#	1	∅	42
	442007			



X225368				
	#	1	∅	42
	442007			



X225371				
	#	1	∅	40
	441848			



X225372				
	#	1	∅	40
	441848			



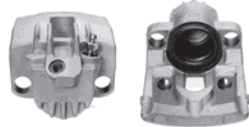

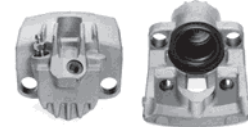

X225373			
	#	1	∅ 38
			
	442048		

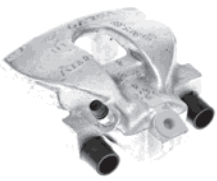

X225374			
	#	1	∅ 38
			
	442048		



X225375			
	#	1	∅ 38
			
	442007		



X225376			
	#	1	∅ 38
			
	442007		

X225381			
	#	1	∅ 40
			
	441848		



X225382			
	#	1	∅ 40
			
	441848		



X225383			
	#	1	∅ 38
			
	441589		



X225384			
	#	1	∅ 38
			
	441589		



X225385			
	#	1	∅ 38
			
	441589		



X225386			
	#	1	∅ 38
			
	441589		



X225387			
	#	1	∅ 40
			
	441848		

X225388			
	#	1	∅ 40
			
	441848		

X225389			
	#	1	∅ 40
			
	441848		

X225390			
	#	1	∅ 40
			
	441848		

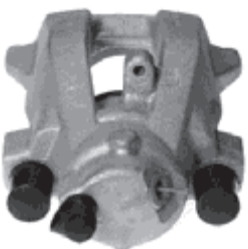
X225391			
	#	1	∅ 42
			
	442007		

X225392			
	#	1	∅ 42
			
	442007		



X225393			
	# 1	∅ 46	
		442190	

X225394			
	# 1	∅ 46	
		442190	

X225395			
	# 2	∅ 42	
		441997	

X225396			
	# 2	∅ 42	
		441997	

X225399			
	# 1	∅ 44	
		442146	

X225400			
	# 1	∅ 44	
		442146	

X225401			
	# 1	∅ 40	
		441532	

X225402			
	# 1	∅ 40	
		441532	

X225403			
	# 1	∅ 40	
		441532	

X225404			
	# 1	∅ 40	
		441532	

X225405			
	# 1	∅ 38	
		441646	

X225406			
	# 1	∅ 38	
		441646	

X225407			
	# 1	∅ 38	
		441646	

X225408			
	# 1	∅ 38	
		441646	

X225409			
	# 1	∅ 34	
		442147	

X225410			
	# 1	∅ 34	
		442147	



X225413				
	#	1	∅	40
	441651			

X225414				
	#	1	∅	40
	441651			

X225415				
	#	1	∅	40
	441651			

X225416				
	#	1	∅	40
	441651			

X225419				
	#	1	∅	42
	442166			

X225420				
	#	1	∅	42
	442166			

X225421				
	#	1	∅	46
	442190			

X225422				
	#	1	∅	46
	442190			

X225423				
	#	1	∅	40
	441651			

X225424				
	#	1	∅	40
	441651			

X225427				
	#	1	∅	38
	442048			

X225428				
	#	1	∅	38
	442048			

X225431				
	#	2	∅	42
	441997			

X225432				
	#	2	∅	42
	441997			

X225433				
	#	1	∅	44
	442146			

X225434				
	#	1	∅	44
	442146			



X225435			
	#	1	∅ 46
	442190		

X225436			
	#	1	∅ 46
	442190		

X225437			
	#	1	∅ 42
	442007		

X225438			
	#	1	∅ 42
	442007		

X225439			
	#	1	∅ 42
	442007		

X225440			
	#	1	∅ 42
	442007		

X225441			
	#	1	∅ 38
	442048		

X225442			
	#	1	∅ 38
	442048		

X225447			
	#	1	∅ 38

X225448			
	#	1	∅ 38

X254001			
	#	1	∅ 45
	441170		

X254002			
	#	1	∅ 45
	441170		

X254003			
	#	1	∅ 48
	441175		



X254004			
	#	1	∅ 48
	441175		

X254007			
	#	1	∅ 48
	441485		

X254008			
	#	1	∅ 48
	441485		









X254009				
	#	1	∅	54
				
	441169			



X254010				
	#	1	∅	54
				
	441169			



X254011				
	#	1	∅	54
				
	441169			



X254012				
	#	1	∅	54
				
	441169			



X254013				
	#	1	∅	48
				
	441175			



X254014				
	#	1	∅	48
				
	441175			



X254015				
	#	1	∅	45
				
	441170			



X254016				
	#	1	∅	45
				
	441170			



X254017				
	#	2	∅	48
				
	441131			



X254018				
	#	2	∅	48
				
	441131			



X254019				
	#	2	∅	40
				
	441182			

X254020				
	#	2	∅	40
				
	441182			

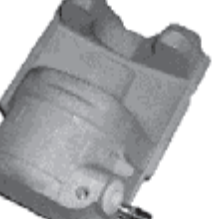
X254021				
	#	1	∅	48
				
				

X254022				
	#	1	∅	48
				
				

X254023				
	#	1	∅	48
				
	441126			

X254024				
	#	1	∅	48
				
	441126			



X254025				
	#	1	∅	50
	441160			

X254026				
	#	1	∅	50
	441160			

X254027				
	#	2	∅	60
	441357			

X254028				
	#	2	∅	60
	441357			

X254029				
	#	2	∅	57
	441222			

X254030				
	#	2	∅	57
	441222			

X254031				
	#	1	∅	48
	441126			

X254032				
	#	1	∅	48
	441126			

X254033				
	#	1	∅	48
	441136			

X254034				
	#	1	∅	48
	441136			

X254035				
	#	1	∅	54
	441800			

X254036				
	#	1	∅	54
	441800			



X254037				
	#	1	∅	54
	441186			

X254038				
	#	1	∅	54
	441186			



X254039				
	#	2	∅	45
	441315			



X254040				
	#	2	∅	45
	441315			









X254041				
	#	1	∅	54
				
	441315			



X254042				
	#	1	∅	54
				
	441169			



X254043				
	#	1	∅	54
				
	441169			

X254044				
	#	1	∅	54
				
	441169			

X254045				
	#	1	∅	48
				
				



X254046				
	#	1	∅	48
				
				



X254047				
	#	2	∅	60
				
	441216			



X254048				
	#	2	∅	60
				
	441216			



X254049				
	#	1	∅	48
				
				



X254050				
	#	1	∅	48
				
				



X254051				
	#	1	∅	45
				
				

X254052				
	#	1	∅	45
				
				



X254053				
	#	2	∅	38
				
	441802			



X254054				
	#	2	∅	38
				
	441802			

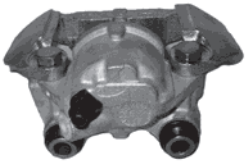

X254055				
	#	2	∅	42
				
	441962			

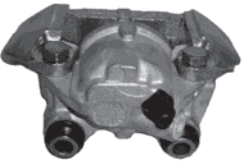

X254056				
	#	2	∅	42
				
	441962			









X254057			
	# 1	∅	48
			
	441175		

X254058			
	# 1	∅	48
			
	441175		

X254059			
	# 2	∅	60
			
	441216		



X254060			
	# 2	∅	60
			
	441216		



X254061			
	# 1	∅	54
			
			



X254062			
	# 1	∅	54
			
			



X254063			
	# 2	∅	42
			
	441180		



X254064			
	# 2	∅	42
			
	441180		



X254065			
	# 1	∅	48
			
	441130		



X254066			
	# 1	∅	48
			
	441130		



X254067			
	# 1	∅	48
			
	441126		

X254068			
	# 1	∅	48
			
	441126		

X254069			
	# 2	∅	40
			
	441182		



X254070			
	# 2	∅	40
			
	441182		



X254071			
	# 1	∅	48
			
	441130		



X254072			
	# 1	∅	48
			
	441130		







X254073				
	#	1	∅	54
				
	441144			

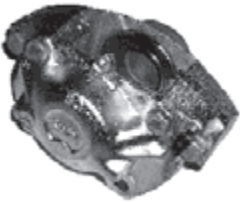

X254074				
	#	1	∅	54
				
	441144			

X254075				
	#	1	∅	48
				
	441126			



X254076				
	#	1	∅	48
				
	441126			



X254077				
	#	2	∅	60
				
	441357			

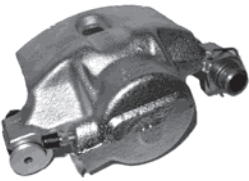

X254078				
	#	2	∅	60
				
	441357			

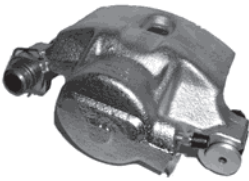

X254079				
	#	2	∅	48
				
	441131			



X254080				
	#	2	∅	48
				
	441131			



X254081				
	#	1	∅	54
				
	441144			



X254082				
	#	1	∅	54
				
	441144			

X254083				
	#	1	∅	48
				
	441126			

X254084				
	#	1	∅	48
				
	441126			



X254085				
	#	1	∅	48
				
	441126			



X254086				
	#	1	∅	48
				
	441126			



X254087				
	#	1	∅	48
				
	441175			



X254088				
	#	1	∅	48
				
	441175			







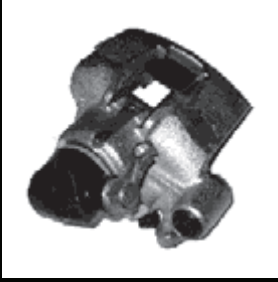

X254089			
	# 1	∅	50
			
	441160		



X254090			
	# 1	∅	50
			
	441160		



X254091			
	# 1	∅	57
			
	441683		



X254092			
	# 1	∅	57
			
	441683		

X254093			
	# 1	∅	48
			
	441126		



X254094			
	# 1	∅	48
			
	441126		



X254095			
	# 1	∅	57
			
	441925		



X254096			
	# 1	∅	57
			
	441925		



X254103			
	# 1	∅	54
			
	441728		

X254104			
	# 1	∅	54
			
	441728		

X254107			
	# 1	∅	54
			
	441728		

X254108			
	# 1	∅	54
			
	441728		

X254111			
	# 2	∅	57
			
			

X254112			
	# 2	∅	57
			
			

X254113			
	# 1	∅	48
			
	441175		

X254114			
	# 1	∅	48
			
	441175		



X254115				
	#	1	∅	57
	441842			

X254116				
	#	1	∅	57
	441842			

X254117				
	#	1	∅	57
	441842			

X254118				
	#	1	∅	57
	441842			

X254119				
	#	1	∅	48
	441485			

X254120				
	#	1	∅	48
	441485			

X254127				
	#	1	∅	48
	441126			

X254128				
	#	1	∅	48
	441126			

X254131				
	#	1	∅	48
	441175			

X254132				
	#	1	∅	48
	441175			

X254133				
	#	2	∅	48
	441152			

X254134				
	#	2	∅	48
	441152			

X254135				
	#	1	∅	54
	441681			

X254136				
	#	1	∅	54
	441681			

X254137				
	#	2	∅	42
	441715			

X254138				
	#	2	∅	42
	441715			



X254139				
	#	2	∅	42
	441715			

X254140				
	#	2	∅	42
	441715			

X254141				
	#	2	∅	52
	441145			

X254142				
	#	2	∅	52
	441145			

X254143				
	#	2	∅	54
	441143			

X254144				
	#	2	∅	54
	441143			

X254145				
	#	1	∅	48
	441965			

X254146				
	#	1	∅	48
	441965			

X254147				
	#	1	∅	45
	441170			

X254148				
	#	1	∅	45
	441170			

X254149				
	#	1	∅	48
	441691			

X254150				
	#	1	∅	48
	441691			

X254151				
	#	1	∅	38
	441129			

X254152				
	#	1	∅	38
	441129			

X254153				
	#	2	∅	48
	441185			

X254154				
	#	2	∅	48
	441185			



X254155				
	#	2	∅	48
	441337			

X254156				
	#	2	∅	48
	441337			

X254157				
	#	1	∅	48
	441485			

X254158				
	#	1	∅	48
	441485			

X254159				
	#	1	∅	60
	441183			

X254160				
	#	1	∅	60
	441183			

X254161				
	#	1	∅	54
	441805			

X254162				
	#	1	∅	54
	441805			

X254163				
	#	1	∅	57
	441842			

X254164				
	#	1	∅	57
	441842			

X254165				
	#	2	∅	48
	441337			

X254166				
	#	2	∅	48
	441337			



X254167				
	#	1	∅	45



X254168				
	#	1	∅	45



X254169				
	#	1	∅	45
	441124			

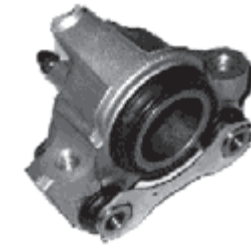

X254170				
	#	1	∅	45
	441124			









X254171			
	# 1	∅	48
			
			



X254172			
	# 1	∅	48
			
			



X254173			
	# 2	∅	40
			
	441182		

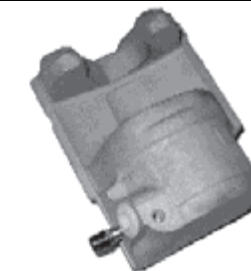

X254174			
	# 2	∅	40
			
	441182		



X254175			
	# 1	∅	48
			
	441130		



X254176			
	# 1	∅	48
			
	441130		



X254177			
	# 1	∅	48
			
	441126		



X254178			
	# 1	∅	48
			
	441126		



X254179			
	# 1	∅	48
			
	441126		



X254180			
	# 1	∅	48
			
	441126		



X254183			
	# 1	∅	48
			
	441130		

X254184			
	# 1	∅	48
			
	441130		



X254187			
	# 1	∅	48
			
	441176		

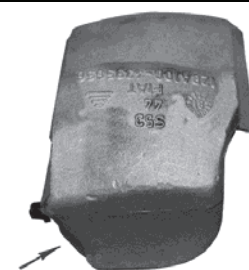

X254188			
	# 1	∅	48
			
			

X254189			
	# 1	∅	48
			
	441126		

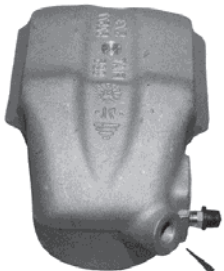

X254190			
	# 1	∅	48
			
	441126		









X254191			
	# 1	∅	48
			
	441126		



X254192			
	# 1	∅	48
			
	441126		



X254193			
	# 1	∅	54
			
	441186		



X254194			
	# 1	∅	54
			
	441186		



X254195			
	# 1	∅	54
			
	441179		

X254196			
	# 1	∅	54
			
	441179		

X254199			
	# 1	∅	48
			
	441126		



X254200			
	# 1	∅	48
			
	441126		



X254201			
	# 2	∅	40
			
	441182		

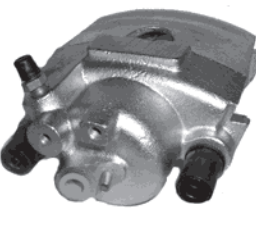

X254202			
	# 2	∅	40
			
	441182		

X254203			
	# 1	∅	48
			
	441792		

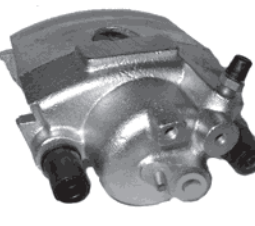
X254204			
	# 1	∅	48
			
	441792		

X254205			
	# 1	∅	48
			
	441791		

X254206			
	# 1	∅	48
			
	441791		

X254207			
	# 1	∅	57
			
	441688		

X254208			
	# 1	∅	57
			
	441688		



X254209				
	#	2	∅	38
	441802			

X254210				
	#	2	∅	38
	441802			

X254211				
	#	2	∅	42
	441962			

X254212				
	#	2	∅	42
	441962			

X254213				
	#	1	∅	48
	441791			

X254214				
	#	1	∅	48
	441791			

X254219				
	#	1	∅	38

X254220				
	#	1	∅	38

X254223				
	#	2	∅	48
	441152			

X254224				
	#	2	∅	48
	441152			

X254229				
	#	1	∅	57
	441683			

X254230				
	#	1	∅	57
	441683			

X254231				
	#	1	∅	60
	442038			

X254232				
	#	1	∅	60
	442038			

X254241				
	#	1	∅	48
	441792			

X254242				
	#	1	∅	48
	441792			



X254251				
	#	2	∅	52
	441145			

X254252				
	#	2	∅	52
	441145			

X255001				
	#	1	∅	45
	442116			

X255002				
	#	1	∅	45
	442116			

X255003				
	#	1	∅	34
	441128			

X255004				
	#	1	∅	34
	441128			

X255005				
	#	2	∅	38
	442105			

X255006				
	#	2	∅	38
	442105			

X255007				
	#	1	∅	30
	441293			

X255008				
	#	1	∅	30
	441293			

X255009				
	#	1	∅	36
	441174			

X255010				
	#	1	∅	36
	441174			

X255011				
	#	1	∅	54
	441169			

X255012				
	#	1	∅	54
	441169			

X255013				
	#	1	∅	36
	441174			

X255014				
	#	1	∅	36
	441174			



X255015			
	# 1	∅ 36	
		441174	

X255016			
	# 1	∅ 36	
		441174	

X255017			
	# 2	∅ 35	
		441261	

X255018			
	# 2	∅ 35	
		441261	

X255019			
	# 2	∅ 38	

X255020			
	# 2	∅ 38	

X255021			
	# 2	∅ 38	
		441217	

X255022			
	# 2	∅ 38	
		441217	

X255023			
	# 2	∅ 46	
		441931	

X255024			
	# 2	∅ 46	
		441931	

X255025			
	# 1	∅ 50	

X255026			
	# 1	∅ 50	

X255027			
	# 2	∅ 35	
		441261	

X255028			
	# 2	∅ 35	
		441261	

X255029			
	# 1	∅ 34	
		441196	

X255030			
	# 1	∅ 34	
		441196	



X255031			
	#	1	∅ 36
	441174		

X255032			
	#	1	∅ 36
	441174		

X255033			
	#	1	∅ 32
	441934		

X255034			
	#	1	∅ 32
	441934		

X255035			
	#	1	∅ 38
	441138		

X255036			
	#	1	∅ 38
	441138		

X255037			
	#	1	∅ 34
	441196		

X255038			
	#	1	∅ 34
	441196		

X255039			
	#	1	∅ 36
	441801		

X255040			
	#	1	∅ 36
	441801		

X255041			
	#	1	∅ 32
	441178		

X255042			
	#	1	∅ 32
	441178		

X255043			
	#	1	∅ 45
	442116		

X255044			
	#	1	∅ 45
	442116		

X255045			
	#	1	∅ 38

X255046			
	#	1	∅ 38



X255047				
	#	1	∅	36
				441174

X255048				
	#	1	∅	36
				441174

X255049				
	#	1	∅	36
				441174

X255050				
	#	1	∅	36
				441174

X255051				
	#	1	∅	30
				441293

X255052				
	#	1	∅	30
				441293

X255053				
	#	1	∅	34
				441128

X255054				
	#	1	∅	34
				441128

X255055				
	#	1	∅	36
				441780

X255056				
	#	1	∅	36
				441780

X255057				
	#	1	∅	50

X255058				
	#	1	∅	50

X255059				
	#	1	∅	38
				441139

X255060				
	#	1	∅	38
				441139



X255061				
	#	-	∅	45



X255062				
	#	-	∅	45









X255063			
	#	1	∅ 32
			
	441178		



X255064			
	#	1	∅ 32
			
	441178		



X255065			
	#	1	∅ 38
			
			



X255066			
	#	1	∅ 38
			
			



X255067			
	#	1	∅ 36
			
	441801		



X255068			
	#	1	∅ 36
			
	441801		



X274003			
	#	1	∅ 54
			
	441806		



X274004			
	#	1	∅ 54
			
	441806		



X274005			
	#	1	∅ 48
			
	441965		



X274006			
	#	1	∅ 48
			
	441965		



X274007			
	#	1	∅ 48
			
	441965		

X274008			
	#	1	∅ 48
			
	441965		

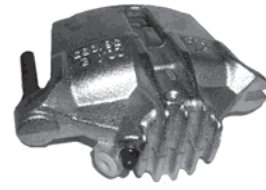
X274009			
	#	1	∅ 48
			
	441965		

X274010			
	#	1	∅ 48
			
	441965		

X274011			
	#	1	∅ 54
			
	441806		

X274012			
	#	1	∅ 54
			
	441806		



X274013				
	#	2	∅	45
	442130			

X274014				
	#	2	∅	45
	442130			

X274015				
	#	1	∅	54
	442026			

X274016				
	#	1	∅	54
	442026			

X274017				
	#	1	∅	57
	442025			

X274018				
	#	1	∅	57
	442025			

X274019				
	#	1	∅	57
	442025			

X274020				
	#	1	∅	57
	442025			

X274021				
	#	1	∅	60
	441957			

X274022				
	#	1	∅	60
	441957			

X274023				
	#	1	∅	54
	442053			

X274024				
	#	1	∅	54
	442053			

X274025				
	#	1	∅	48
	442052			

X274026				
	#	1	∅	48
	442052			

X274027				
	#	1	∅	48
	442052			

X274028				
	#	1	∅	48
	442052			



X274029				
	#	1	∅	54
	442053			

X274030				
	#	1	∅	54
	442053			

X274031				
	#	1	∅	54
	442053			

X274032				
	#	1	∅	54
	442053			

X274033				
	#	1	∅	54
	442053			

X274034				
	#	1	∅	54
	442053			

X274035				
	#	1	∅	57
	442004			

X274036				
	#	1	∅	57
	442004			

X274037				
	#	1	∅	48
	442039			

X274038				
	#	1	∅	48
	442039			

X274039				
	#	1	∅	54
	442053			

X274040				
	#	1	∅	54
	442053			

X274041				
	#	1	∅	51
	442251			

X274042				
	#	1	∅	51
	442251			

X274045				
	#	1	∅	57
	442004			

X274046				
	#	1	∅	57
	442004			



X274047				
	#	2	∅	48
				442057

X274048				
	#	2	∅	48
				442057

X274049				
	#	2	∅	45
				441971

X274050				
	#	2	∅	45
				441971

X274051				
	#	2	∅	45
				441971

X274052				
	#	2	∅	45
				441971

X274053				
	#	1	∅	54
				442053

X274054				
	#	1	∅	54
				442053

X274055				
	#	1	∅	54
				442053

X274056				
	#	1	∅	54
				442053

X274057				
	#	1	∅	48
				442037

X274058				
	#	1	∅	48
				442037

X274059				
	#	1	∅	48
				442052

X274060				
	#	1	∅	48
				442052

X274061				
	#	2	∅	45
				442130

X274062				
	#	2	∅	45
				442130



X274063				
	#	2	∅	48
	442200			

X274064				
	#	2	∅	48
	442200			

X274065				
	#	2	∅	45
	441971			

X274066				
	#	2	∅	45
	441971			

X274067				
	#	1	∅	60
	441517			

X274068				
	#	1	∅	60
	441517			

X274069				
	#	1	∅	57
	442004			

X274070				
	#	1	∅	57
	442004			

X274071				
	#	1	∅	54
	442053			

X274072				
	#	1	∅	54
	442053			

X274073				
	#	1	∅	42
	442129			

X274074				
	#	1	∅	42
	442129			



X274075				
	#	1	∅	54
	442053			



X274076				
	#	1	∅	54
	442053			



X274077				
	#	1	∅	54
	442053			



X274078				
	#	1	∅	54
	442053			









X274079				
	#	1	∅	54
				
	442053			



X274080				
	#	1	∅	54
				
	442053			



X274081				
	#	1	∅	54
				
	441373			



X274082				
	#	1	∅	54
				
	441373			



X274083				
	#	1	∅	48
				
	441487			



X274084				
	#	1	∅	48
				
	441487			



X274085				
	#	2	∅	48
				
	442424			



X274086				
	#	2	∅	48
				
	442424			



X274087				
	#	1	∅	48
				
	442052			



X274088				
	#	1	∅	48
				
	442052			



X274089				
	#	2	∅	48
				
	442318			

X274090				
	#	2	∅	48
				
	442318			

X274091				
	#	1	∅	57
				
	442004			

X274092				
	#	1	∅	57
				
	442004			

X274093				
	#	1	∅	57
				
	442004			

X274094				
	#	1	∅	57
				
	442004			



X274095				
	#	1	∅	54
	442053			

X274096				
	#	1	∅	54
	442053			

X274099				
	#	1	∅	57
	442004			

X274100				
	#	1	∅	57
	442004			

X274101				
	#	1	∅	42
	442129			

X274102				
	#	1	∅	42
	442129			

X274103				
	#	1	∅	57
	442004			

X274104				
	#	1	∅	57
	442004			

X274105				
	#	1	∅	60
	441630			

X274106				
	#	1	∅	60
	441630			

X274107				
	#	1	∅	60
	441630			

X274108				
	#	1	∅	60
	441630			



X274111				
	#	2	∅	48
	441554			



X274112				
	#	2	∅	48
	441554			

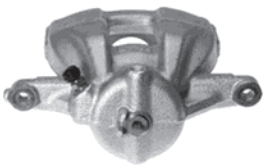

X274113				
	#	1	∅	48
	441965			

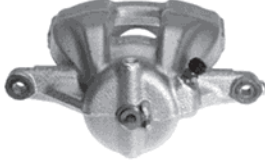

X274114				
	#	1	∅	48
	441965			







X274115				
	#	1	∅	60
				
	441592			

X274116				
	#	1	∅	60
				
	441592			

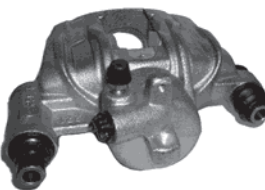
X274117				
	#	1	∅	57
				
	442004			



X274118				
	#	1	∅	57
				
	442004			



X275001				
	#	1	∅	52
				
	441845			

X275002				
	#	1	∅	52
				
	441845			



X275003				
	#	1	∅	34
				
	442070			



X275004				
	#	1	∅	34
				
	442070			



X275005				
	#	1	∅	36
				
	441833			

X275006				
	#	1	∅	36
				
	441833			

X275007				
	#	1	∅	38
				
	442069			

X275008				
	#	1	∅	38
				
	442069			



X275015				
	#	1	∅	38
				
	442003			



X275016				
	#	1	∅	38
				
	442003			

X275017				
	#	1	∅	38
				
	441832			

X275018				
	#	1	∅	38
				
	441832			



X275019			
	#	1	∅ 38
			
	442003		

X275020			
	#	1	∅ 38
			
	442003		



X275021			
	#	1	∅ 33
			
	442019		



X275022			
	#	1	∅ 33
			
	442019		



X275023			
	#	1	∅ 42
			
	441979		

X275024			
	#	1	∅ 42
			
	441979		

X275025			
	#	1	∅ 38
			
	441620		



X275026			
	#	1	∅ 38
			
	441620		



X275027			
	#	1	∅ 38
			
	442003		



X275028			
	#	1	∅ 38
			
	442003		



X275029			
	#	1	∅ 38
			
	442003		

X275030			
	#	1	∅ 38
			
	442003		



X275031			
	#	1	∅ 38
			
	442154		



X275032			
	#	1	∅ 38
			
	442154		

X275033			
	#	1	∅ 38
			
	442154		

X275034			
	#	1	∅ 38
			
	442154		









X275035			
	# 1	∅ 38	
			
	442157		



X275036			
	# 1	∅ 38	
			
	442157		



X275037			
	# 1	∅ 38	
			
	442201		



X275038			
	# 1	∅ 38	
			
	442201		



X275039			
	# 2	∅ 48	
			
	442473		



X275040			
	# 2	∅ 48	
			
	442473		



X275041			
	# 1	∅ 38	
			
	441620		



X275042			
	# 1	∅ 38	
			
	441620		



X275045			
	# 1	∅ 51	
			
	442367		



X275046			
	# 1	∅ 51	
			
	442367		



X275047			
	# 1	∅ 36	
			
	441477		

X275048			
	# 1	∅ 36	
			
	441477		

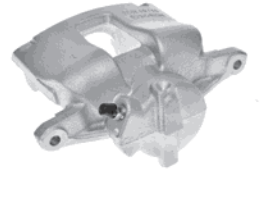
X275049			
	# 1	∅ 38	
			
	442154		

X275050			
	# 1	∅ 38	
			
	442154		

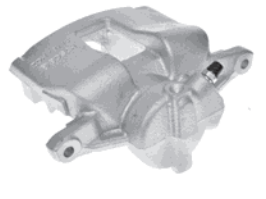
X275051			
	# 1	∅ 48	
			
	442052		

X275052			
	# 1	∅ 48	
			
	442052		



X275053			
	#	- Ø	48
	441585		

X275054			
	#	- Ø	48
	441585		

X275055			
	#	1 Ø	38
	441553		

X275056			
	#	1 Ø	38
	441553		

X275057			
	#	1 Ø	38
	442154		

X275058			
	#	1 Ø	38
	442154		

X275059			
	#	1 Ø	36
	441477		

X275060			
	#	1 Ø	36
	441477		

X275061			
	#	1 Ø	38
	442154		

X275062			
	#	1 Ø	38
	442154		

X275063			
	#	1 Ø	38
	441684		

X275064			
	#	1 Ø	38
	441684		



X275065			
	#	1 Ø	38
	441620		



X275066			
	#	1 Ø	38
	441620		



X275067			
	#	1 Ø	38
	441553		



X275068			
	#	1 Ø	38
	441553		



X275069			
	# 2	∅	45
			
			



X275070			
	# 2	∅	45
			
			



X275071			
	# 1	∅	36
			
	441477		



X275072			
	# 1	∅	36
			
	441477		



X275073			
	# 1	∅	38
			
	441620		



X275074			
	# 1	∅	38
			
	441620		



X284001			
	# 4	∅	42
			
	441869		

X284002			
	# 4	∅	42
			
	441869		



X284003			
	# 4	∅	44
			
	441949		

X284004			
	# 4	∅	44
			
	441949		

X284005			
	# 2	∅	48
			
	441185		

X284006			
	# 2	∅	48
			
	441185		



X284013			
	# 4	∅	40/44
			
	442220		



X284014			
	# 4	∅	40/44
			
	442220		

X284015			
	# 4	∅	38/42
			
	442238		

X284016			
	# 4	∅	38/42
			
	442238		









X284017			
	# 4	∅ 36/40	
			
			



X284018			
	# 4	∅ 36/40	
			
			



X284021			
	# 2	∅ 44	
			
		442215	



X284022			
	# 2	∅ 44	
			
		442215	



X284023			
	# 2	∅ 48	
			
			

X284024			
	# 2	∅ 48	
			
			



X284029			
	# 2	∅ 46/52	
			
		442046	



X284030			
	# 2	∅ 46/52	
			
		442046	



X284033			
	# 4	∅ 42	
			
		441869	

X284034			
	# 4	∅ 42	
			
		441869	

X284037			
	# 2	∅ 42	
			
		442224	

X284038			
	# 2	∅ 42	
			
		442224	

X284039			
	# 2	∅ 60	
			
		441591	

X284040			
	# 2	∅ 60	
			
		441591	

X284041			
	# 2	∅ 44	
			
		442215	

X284042			
	# 2	∅ 44	
			
		442215	



X284043				
	#	2	∅	52
				442265

X284044				
	#	2	∅	52
				442265

X284045				
	#	2	∅	44/48
				442045

X284046				
	#	2	∅	44/48
				442045

X284047				
	#	2	∅	44/48
				442045

X284048				
	#	2	∅	44/48
				442045

X284049				
	#	2	∅	46/52
				442046

X284050				
	#	2	∅	46/52
				442046

X284057				
	#	4	∅	40/44
				442220

X284058				
	#	4	∅	40/44
				442220

X284079				
	#	2	∅	44
				442015

X284080				
	#	2	∅	44
				442015



X284083				
	#	4	∅	40/44
				442220



X284084				
	#	4	∅	40/44
				442220

X284087				
	#	2	∅	52
				441488



X284088				
	#	2	∅	52
				441488









X284089			
	# 6	∅ 0/34/3	
			
	442175		



X284090			
	# 6	∅ 0/34/3	
			
	442175		



X284091			
	# 2	∅ 52	
			
	442265		



X284092			
	# 2	∅ 52	
			
	442265		



X284093			
	# 2	∅ 44/48	
			
	442045		



X284094			
	# 2	∅ 44/48	
			
	442045		



X284095			
	# 2	∅ 46/52	
			
	442046		



X284096			
	# 2	∅ 46/52	
			
	442046		



X284097			
	# 2	∅ 46/52	
			
	442046		



X284098			
	# 2	∅ 46/52	
			
	442046		



X284099			
	# 2	∅ 48	
			
	442339		

X284100			
	# 2	∅ 48	
			
	442339		



X284103			
	# 2	∅ 60	
			
	441591		



X284104			
	# 2	∅ 60	
			
	441591		

X284105			
	# 2	∅ 48	
			
	442339		

X284106			
	# 2	∅ 48	
			
	442339		









X284113			
	# 4	∅	40/44
			
	442220		



X284114			
	# 4	∅	40/44
			
	442220		



X284115			
	# 4	∅	38/42
			
			



X284116			
	# 4	∅	38/42
			
			



X284117			
	# 2	∅	46/52
			
	442046		



X284118			
	# 2	∅	46/52
			
	442046		



X284121			
	# 2	∅	57
			
			

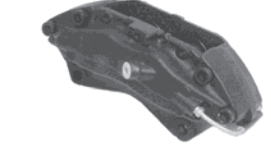

X284122			
	# 2	∅	57
			
			



X284123			
	# 4	∅	46
			
	442453		



X284124			
	# 4	∅	46
			
	442453		

X284125			
	# 4	∅	38/42
			
			

X284126			
	# 4	∅	38/42
			
			



X284127			
	# 4	∅	40
			
	442230		



X284128			
	# 4	∅	40
			
	442230		



X284131			
	# 2	∅	48
			
			



X284132			
	# 2	∅	48
			
			



X284137			
	# 2	∅	44
			
	442215		

X284138			
	# 2	∅	44
			
	442215		

X284141			
	# 4	∅	44
			
	442317		



X284142			
	# 4	∅	44
			
	442317		



X284145			
	# 4	∅	40/44
			
	442220		



X284146			
	# 4	∅	40/44
			
	442220		



X284151			
	# 4	∅	38/42
			
			



X284152			
	# 4	∅	38/42
			
			



X284153			
	# 4	∅	38/42
			
			

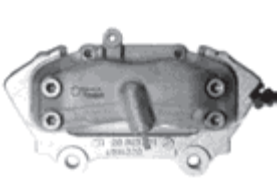

X284154			
	# 4	∅	38/42
			
			

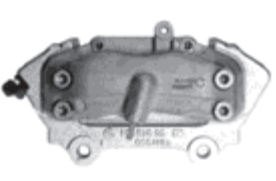

X284155			
	# 4	∅	42
			
			

X284156			
	# 4	∅	42
			
			

X284157			
	# 4	∅	40/44
			
	442220		

X284158			
	# 4	∅	40/44
			
	442220		

X284159			
	# 6	∅	28
			
	441473		

X284160			
	# 6	∅	28
			
	441473		



X284161			
	# 6	∅	36
	441590		

X284162			
	# 6	∅	36
	441590		

X284171			
	# 2	∅	48
	441677		

X284172			
	# 2	∅	48
	441677		

X284181			
	# 2	∅	48
	442339		

X284182			
	# 2	∅	48
	442339		

X284183			
	# 4	∅	38/44
	441564		

X284184			
	# 4	∅	38/44
	441564		

X284185			
	# 4	∅	38/42

X284186			
	# 4	∅	38/42

X284187			
	# 4	∅	40
	442230		

X284188			
	# 4	∅	40
	442230		



X284189			
	# 4	∅	40
	442230		



X284190			
	# 4	∅	40
	442230		

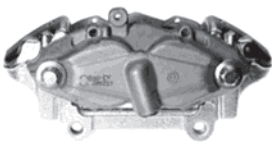

X284195			
	# 4	∅	40/44
	442220		

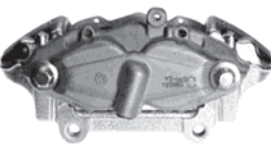

X284196			
	# 4	∅	40/44
	442220		









X284197			
	# 4	∅	44
			
	442317		



X284198			
	# 4	∅	44
			
	442317		

X284199			
	# 4	∅	38/42
			
			



X284200			
	# 4	∅	38/42
			
			

X284201			
	# 4	∅	40/44
			
	442220		

X284202			
	# 4	∅	40/44
			
	442220		

X284203			
	# 4	∅	40/44
			
	442220		

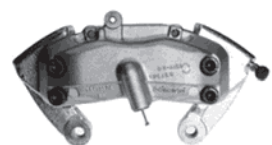

X284204			
	# 4	∅	40/44
			
	442220		



X284205			
	# 4	∅	40/44
			
	442220		

X284206			
	# 4	∅	40/44
			
	442220		

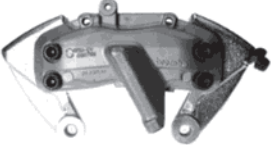
X284219			
	# 4	∅	40
			
			

X284220			
	# 4	∅	40
			
			

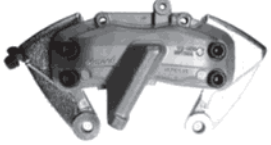

X284221			
	# 4	∅	40/44
			
	442220		



X284222			
	# 4	∅	40/44
			
	442220		

X284223			
	# 4	∅	44
			
	442317		

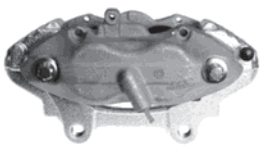
X284224			
	# 4	∅	44
			
	442317		



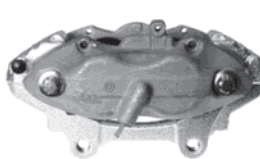





X284225			
	# 4	∅	44
			
	442317		



X284226			
	# 4	∅	44
			
	442317		



X284227			
	# 4	∅	38/44
			
	441564		



X284228			
	# 4	∅	38/44
			
	441564		



X285001			
	# 1	∅	36
			
	441759		

X285002			
	# 1	∅	36
			
	441759		



X285003			
	# 1	∅	36
			
	441759		



X285004			
	# 1	∅	36
			
	441759		

X285005			
	# 1	∅	36
			
	441759		



X285006			
	# 1	∅	36
			
	441759		

X285011			
	# 1	∅	36
			
	441759		

X285012			
	# 1	∅	36
			
	441759		



X285021			
	# 1	∅	52
			
	442216		



X285022			
	# 1	∅	52
			
	442216		



X285029			
	# 2	∅	46
			
	442264		

X285030			
	# 2	∅	46
			
	442264		









X285031			
	# 1	∅	46
			
	442047		



X285032			
	# 1	∅	46
			
	442047		



X285037			
	# 2	∅	44
			
	442215		



X285038			
	# 2	∅	44
			
	442215		



X285039			
	# 2	∅	44
			
	442015		



X285040			
	# 2	∅	44
			
	442015		



X285041			
	# 2	∅	40
			
	442221		



X285042			
	# 2	∅	40
			
	442221		



X285045			
	# 2	∅	46
			
	442264		

X285046			
	# 2	∅	46
			
	442264		



X285047			
	# 1	∅	46
			
	441486		

X285048			
	# 1	∅	46
			
	441486		

X285049			
	# 2	∅	48
			
			

X285050			
	# 2	∅	48
			
			

X285051			
	# 1	∅	60
			
	441490		

X285052			
	# 1	∅	60
			
	441490		



X285061			
	# 2	∅	44

X285062			
	# 2	∅	44

X285063			
	# 4	∅	28/30
	442177		

X285064			
	# 4	∅	28/30
	442177		

X285069			
	# 1	∅	48
	445342		

X285070			
	# 1	∅	48
	445342		

X285071			
	# 4	∅	28/30
	442177		

X285072			
	# 4	∅	28/30
	442177		

X285073			
	# 4	∅	30

X285074			
	# 4	∅	30

X285081			
	# 1	∅	60

X285082			
	# 1	∅	60



X285095			
	# 4	∅	28/32



X285096			
	# 4	∅	28/32



X285097			
	# 4	∅	28/30
	442177		



X285098			
	# 4	∅	28/30
	442177		







X314007				
	#	2	∅	45
				
	441161			

X314008				
	#	2	∅	45
				
	441161			

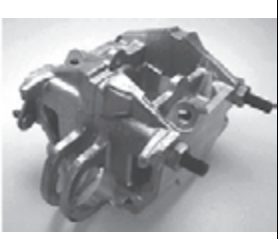
X314011				
	#	2	∅	45
				
	441146			

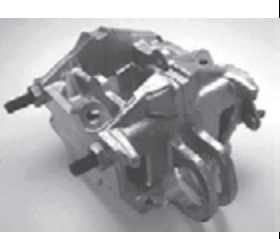

X314012				
	#	2	∅	45
				
	441146			



X314013				
	#	2	∅	45
				
	441141			



X314014				
	#	2	∅	45
				
	441141			



X314015				
	#	2	∅	42
				
	441140			

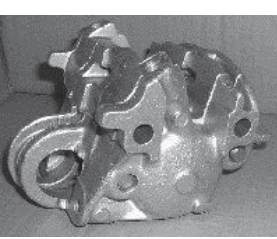

X314016				
	#	2	∅	42
				
	441140			

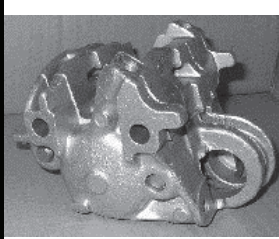

X314017				
	#	2	∅	60
				
				



X314018				
	#	2	∅	60
				
				



X314019				
	#	2	∅	42
				
	441140			

X314020				
	#	2	∅	42
				
	441140			

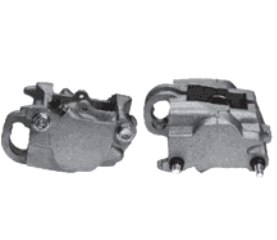

X314021				
	#	2	∅	45
				
	441141			

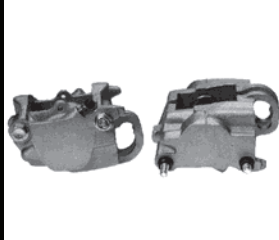

X314022				
	#	2	∅	45
				
	441141			



X314023				
	#	2	∅	45
				
				

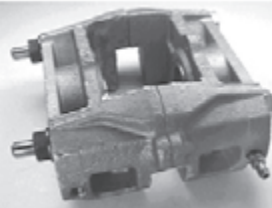

X314024				
	#	2	∅	45
				
				









X315001				
	#	2	∅	40
				
				

X315002				
	#	2	∅	40
				
				

X315003				
	#	2	∅	30
				
	441142			



X315004				
	#	2	∅	30
				
	441142			

X315005				
	#	2	∅	30
				
	441466			



X315006				
	#	2	∅	30
				
	441466			



X315009				
	#	2	∅	33
				
	441466			



X315010				
	#	2	∅	33
				
	441466			



X315011				
	#	2	∅	40
				
	441469			

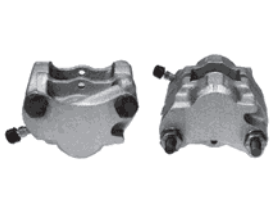

X315012				
	#	2	∅	40
				
	441469			

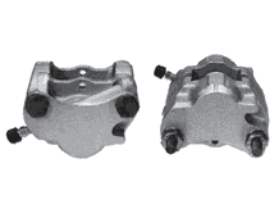

X315013				
	#	2	∅	42
				
	441469			

X315014				
	#	2	∅	42
				
	441140			

X315015				
	#	2	∅	30
				
	441142			

X315016				
	#	2	∅	30
				
	441142			

X315017				
	#	2	∅	36
				
	441938			

X315018				
	#	2	∅	36
				
	441938			



X315019				
	#	2	∅	30
	441151			

X315020				
	#	2	∅	30
	441151			

X315023				
	#	2	∅	32
	442031			

X315024				
	#	2	∅	32
	442031			

X324001				
	#	1	∅	54
	442142			

X324002				
	#	1	∅	54
	442142			

X324003				
	#	1	∅	48
	442149			

X324004				
	#	1	∅	48
	442149			

X324005				
	#	1	∅	48
	442150			

X324006				
	#	1	∅	48
	442150			

X324007				
	#	1	∅	52
	442161			

X324008				
	#	1	∅	52
	442161			



X324009				
	#	1	∅	52
	442074			



X324010				
	#	1	∅	52
	442074			



X324011				
	#	1	∅	57
	442145			



X324012				
	#	1	∅	57
	442145			









X324013				
	#	1	∅	48
				
	442149			



X324014				
	#	1	∅	48
				
	442149			



X324015				
	#	1	∅	48
				
	442149			



X324016				
	#	1	∅	48
				
	442149			



X324017				
	#	1	∅	57
				
	442145			

X324018				
	#	1	∅	57
				
	442145			



X324019				
	#	1	∅	52
				
	442074			



X324020				
	#	1	∅	52
				
	442074			



X324021				
	#	1	∅	54
				
	441656			



X324022				
	#	1	∅	54
				
	441656			



X325001				
	#	1	∅	32
				
	441708			

X325002				
	#	1	∅	32
				
	441708			



X325003				
	#	1	∅	32
				
	441708			



X325004				
	#	1	∅	32
				
	441708			



X325005				
	#	1	∅	32
				
	442139			



X325006				
	#	1	∅	32
				
	442139			









X325007			
	# 1	∅	35
			
	442141		



X325008			
	# 1	∅	35
			
	442141		



X325009			
	# 1	∅	35
			
	442140		



X325010			
	# 1	∅	35
			
	442140		



X344001			
	# 2	∅	46
			
	442029		

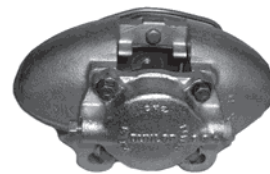

X344002			
	# 2	∅	46
			
	442029		

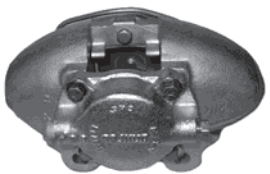

X344005			
	# 2	∅	54
			
			



X344006			
	# 2	∅	54
			
			



X344007			
	# 2	∅	54
			
			



X344008			
	# 2	∅	54
			
			



X344027			
	# 2	∅	54
			
			

X344028			
	# 2	∅	54
			
			

X345003			
	# 2	∅	38
			
			

X345004			
	# 2	∅	38
			
			

X374001			
	# 1	∅	54
			
	441195		

X374002			
	# 1	∅	54
			
	441195		



X374003			
	# 1	∅ 48	
	441958		

X374004			
	# 1	∅ 48	
	441958		

X374005			
	# 1	∅ 48	
	441958		

X374006			
	# 1	∅ 48	
	441958		

X374007			
	# 1	∅ 48	
	441164		

X374008			
	# 1	∅ 48	
	441164		

X374009			
	# 1	∅ 54	
	441173		

X374010			
	# 1	∅ 54	
	441173		

X374011			
	# 2	∅ 38/48	
	441154		

X374012			
	# 2	∅ 38/48	
	441154		

X374013			
	# 2	∅ 38/48	
	441154		

X374014			
	# 2	∅ 38/48	
	441154		



X374015			
	# 1	∅ 48	
	441663		



X374016			
	# 1	∅ 48	
	441663		



X374017			
	# 1	∅ 48	
	441663		



X374018			
	# 1	∅ 48	
	441663		







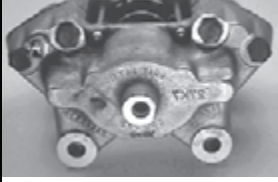

X374019			
	# 4	∅	36
			
	441207		



X374020			
	# 4	∅	36
			
	441207		

X374023			
	# 2	∅	48
			
	441131		



X374024			
	# 2	∅	48
			
	441131		



X374025			
	# 1	∅	48
			
	441164		



X374026			
	# 1	∅	48
			
	441164		



X374027			
	# 1	∅	45
			
	441187		



X374028			
	# 1	∅	45
			
	441187		



X374029			
	# 1	∅	48
			
	441164		



X374030			
	# 1	∅	48
			
	441164		

X374031			
	# 1	∅	54
			
	441195		

X374032			
	# 1	∅	54
			
	441195		

X374033			
	# 3	∅	38/54
			
	442126		

X374034			
	# 3	∅	38/54
			
	442126		

X374035			
	# 1	∅	54
			
	441195		

X374036			
	# 1	∅	54
			
	441195		



X374037			
	# 1	∅	54
	441195		

X374038			
	# 1	∅	54
	441195		

X374039			
	# 2	∅	54
	441143		

X374040			
	# 2	∅	54
	441143		

X374041			
	# 2	∅	40/45
	441996		

X374042			
	# 2	∅	40/45
	441996		

X374043			
	# 2	∅	54
	441143		

X374044			
	# 2	∅	54
	441143		

X374045			
	# 2	∅	48
	441937		

X374046			
	# 2	∅	48
	441937		

X374047			
	# 1	∅	60
	441181		

X374048			
	# 1	∅	60
	441181		

X374051			
	# 2	∅	44

X374052			
	# 2	∅	44

X374053			
	# 2	∅	40
	441689		

X374054			
	# 2	∅	40
	441689		



X374055				
	#	2	∅	54

X374056				
	#	2	∅	54

X374057				
	#	2	∅	48

X374058				
	#	2	∅	48

X374059				
	#	2	∅	48
	441131			

X374060				
	#	2	∅	48
	441131			

X374063				
	#	2	∅	44

X374064				
	#	2	∅	44

X374065				
	#	2	∅	54

X374066				
	#	2	∅	54

X374069				
	#	1	∅	54
	441195			

X374070				
	#	1	∅	54
	441195			

X374071				
	#	2	∅	51

X374072				
	#	2	∅	51

X374073				
	#	2	∅	44
	441166			

X374074				
	#	2	∅	44
	441166			



X374075				
	#	2	∅	54
	441628			

X374076				
	#	2	∅	54
	441628			

X374077				
	#	2	∅	48
	441131			

X374078				
	#	2	∅	48
	441131			

X374079				
	#	1	∅	48
	441663			

X374080				
	#	1	∅	48
	441663			

X374081				
	#	1	∅	48
	441663			

X374082				
	#	1	∅	48
	441663			

X374083				
	#	1	∅	54
	441195			

X374084				
	#	1	∅	54
	441195			

X374085				
	#	1	∅	54
	441195			

X374086				
	#	1	∅	54
	441195			

X374091				
	#	2	∅	54

X374092				
	#	2	∅	54

X374093				
	#	4	∅	36
	441207			

X374094				
	#	4	∅	36
	441207			



X374095			
	# 1	∅	48
			441663

X374096			
	# 1	∅	48
			441663

X374097			
	# 2	∅	48
			441131

X374098			
	# 2	∅	48
			441131

X374101			
	# 1	∅	54
			441195

X374102			
	# 1	∅	54
			441195

X374103			
	# 4	∅	38
			441184

X374104			
	# 4	∅	38
			441184

X374105			
	# 2	∅	48

X374106			
	# 2	∅	48

X374107			
	# 1	∅	45
			441187

X374108			
	# 1	∅	45
			441187



X374109			
	# 2	∅	40
			441494



X374110			
	# 2	∅	40
			441494



X374111			
	# 2	∅	40
			441494

X374112			
	# 2	∅	40
			441494









X374113			
	# 4	∅	38
			
	441184		



X374114			
	# 4	∅	38
			
	441184		



X374115			
	# 1	∅	48
			
	441663		



X374116			
	# 1	∅	48
			
	441663		



X374117			
	# 1	∅	48
			
	441151		



X374118			
	# 1	∅	48
			
	441151		



X374119			
	# 1	∅	54
			
	441195		



X374120			
	# 1	∅	54
			
	441195		

X374123			
	# 2	∅	54
			
	441143		

X374124			
	# 2	∅	54
			
	441143		

X374125			
	# 2	∅	48
			
	441131		

X374126			
	# 2	∅	48
			
	441131		

X374131			
	# 1	∅	54
			
	441195		

X374132			
	# 1	∅	54
			
	441195		

X374133			
	# 1	∅	54
			
	441195		

X374134			
	# 1	∅	54
			
	441195		



X374137				
	#	1	∅	54

X374138				
	#	1	∅	54

X374143				
	#	1	∅	57
				441700

X374144				
	#	1	∅	57
				441700

X374145				
	#	1	∅	54
				441525

X374146				
	#	1	∅	54
				441525

X374147				
	#	1	∅	60
				441181

X374148				
	#	1	∅	60
				441181

X374151				
	#	1	∅	54
				441195

X374152				
	#	1	∅	54
				441195

X374155				
	#	1	∅	48
				441158

X374156				
	#	1	∅	48
				441158



X374157				
	#	1	∅	48
				441663

X374158				
	#	1	∅	48
				441663



X374159				
	#	2	∅	43/48
				441203



X374160				
	#	2	∅	43/48
				441203





X374161				
	#	1	∅	48
				
	441663			

X374162				
	#	1	∅	48
				
	441663			

X374165				
	#	1	∅	54
				
	441525			



X374166				
	#	1	∅	54
				
	441525			



X374167				
	#	1	∅	54
				
	441891			



X374168				
	#	1	∅	54
				
	441891			



X374169				
	#	1	∅	54
				
	441195			



X374170				
	#	1	∅	54
				
	441195			



X374171				
	#	1	∅	60
				
	441181			



X374172				
	#	1	∅	60
				
	441181			



X374173				
	#	4	∅	48
				
	441744			

X374174				
	#	4	∅	48
				
	441744			



X374177				
	#	4	∅	38
				
	441184			



X374178				
	#	4	∅	38
				
	441184			

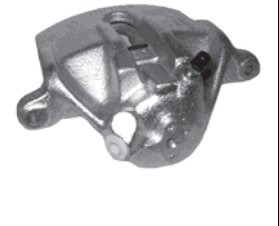

X374179				
	#	1	∅	57
				
	441649			

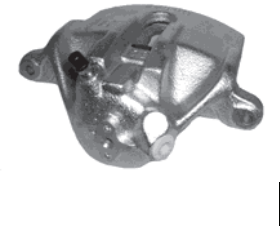

X374180				
	#	1	∅	57
				
	441649			



X374187			
	# 1	∅	54
			
	441195		

X374188			
	# 1	∅	54
			
	441195		

X374191			
	# 1	∅	54
			
	441195		



X374192			
	# 1	∅	54
			
	441195		



X374193			
	# 2	∅	40/45
			
	441787		



X374194			
	# 2	∅	40/45
			
	441787		



X374195			
	# 1	∅	54
			
	441195		



X374196			
	# 1	∅	54
			
	441195		



X374197			
	# 1	∅	54
			
	441195		



X374198			
	# 1	∅	54
			
	441195		



X374199			
	# 1	∅	54
			
	441195		

X374200			
	# 1	∅	54
			
	441195		



X374201			
	# 1	∅	57
			
	441742		

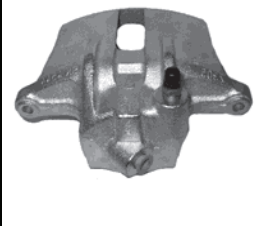

X374202			
	# 1	∅	57
			
	441742		

X374203			
	# 1	∅	54
			
	441195		

X374204			
	# 1	∅	54
			
	441195		



X374205			
	# 1	∅	54
			
	441195		



X374206			
	# 1	∅	54
			
	441195		

X374207			
	# 1	∅	54
			
	441525		



X374208			
	# 1	∅	54
			
	441525		

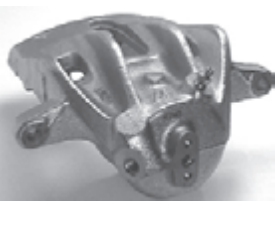

X374209			
	# 1	∅	54
			
	441525		



X374210			
	# 1	∅	54
			
	441525		



X374211			
	# 1	∅	57
			
	441649		

X374212			
	# 1	∅	57
			
	441649		

X374215			
	# 1	∅	54
			
	441891		



X374216			
	# 1	∅	54
			
	441891		



X374217			
	# 4	∅	48
			
	441744		

X374218			
	# 4	∅	48
			
	441744		



X374223			
	# 2	∅	40/48
			
	441734		



X374224			
	# 2	∅	40/48
			
	441734		



X374225			
	# 2	∅	40/48
			
	441734		



X374226			
	# 2	∅	40/48
			
	441734		









X374227			
	# 2	∅	40/48
			
	441734		



X374228			
	# 2	∅	40/48
			
	441734		



X374229			
	# 2	∅	40/48
			
	441734		

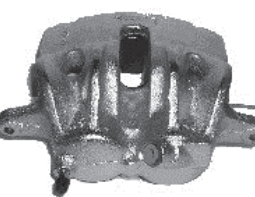

X374230			
	# 2	∅	40/48
			
	441734		

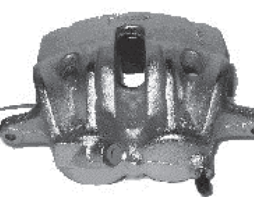

X374231			
	# 2	∅	45/48
			
	441733		



X374232			
	# 2	∅	45/48
			
	441733		



X374233			
	# 2	∅	45/48
			
	441733		



X374234			
	# 2	∅	45/48
			
	441733		



X374235			
	# 1	∅	57
			
	441649		

X374236			
	# 1	∅	57
			
	441649		

X374237			
	# 1	∅	57
			
	441742		

X374238			
	# 1	∅	57
			
	441742		

X374255			
	# 1	∅	54
			
	441195		

X374256			
	# 1	∅	54
			
	441195		



X374257			
	# 1	∅	54
			
	441195		



X374258			
	# 1	∅	54
			
	441195		









X374259			
	# 4	∅ 40/44	
			
	441946		

X374260			
	# 4	∅ 40/44	
			
	441946		

X374261			
	# 1	∅ 48	
			
	441663		



X374262			
	# 1	∅ 48	
			
	441663		

X374263			
	# 1	∅ 54	
			
	442103		



X374264			
	# 1	∅ 54	
			
	442103		



X374265			
	# 1	∅ 54	
			
	441195		



X374266			
	# 1	∅ 54	
			
	441195		



X374267			
	# 1	∅ 54	
			
	441195		



X374268			
	# 1	∅ 54	
			
	441195		



X374269			
	# 1	∅ 48	
			
	441195		

X374270			
	# 1	∅ 48	
			
	441195		

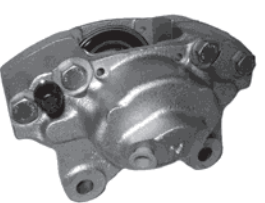
X374271			
	# 1	∅ 48	
			
			

X374272			
	# 1	∅ 48	
			
			

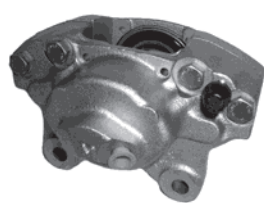
X374275			
	# 2	∅ 48	
			
	441131		

X374276			
	# 2	∅ 48	
			
	441131		



X374277			
	# 1	∅	48
	441663		

X374278			
	# 1	∅	48
	441663		

X374279			
	# 1	∅	48
	441465		

X374280			
	# 1	∅	48
	441465		

X374281			
	# 1	∅	57
	441700		

X374282			
	# 1	∅	57
	441700		

X374283			
	# 2	∅	48
	441131		

X374284			
	# 2	∅	48
	441131		

X374285			
	# 1	∅	48
	441282		

X374286			
	# 1	∅	48
	441282		

X374287			
	# 1	∅	48
	441282		

X374288			
	# 1	∅	48
	441282		

X374289			
	# 1	∅	48
	441282		

X374290			
	# 1	∅	48
	441282		

X374291			
	# 1	∅	54
	441195		

X374292			
	# 1	∅	54
	441195		



X374293			
	# 1	∅	57
	441649		

X374294			
	# 1	∅	57
	441649		

X374299			
	# 2	∅	54
	441839		

X374300			
	# 2	∅	54
	441839		

X374303			
	# 2	∅	48
	441143		

X374304			
	# 2	∅	48
	441131		

X374309			
	# 2	∅	54
	441191		

X374310			
	# 2	∅	54
	441191		

X374311			
	# 2	∅	48
	441131		

X374312			
	# 2	∅	48
	441131		

X374313			
	# 2	∅	48
	441209		

X374314			
	# 2	∅	48
	441209		



X374315			
	# 2	∅	54
	441143		



X374316			
	# 2	∅	54
	441143		



X374317			
	# 2	∅	54



X374318			
	# 2	∅	54



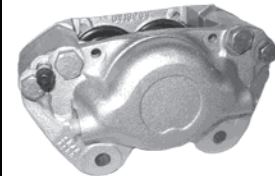



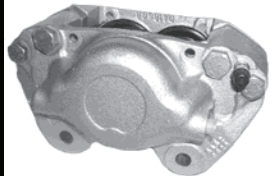

X374319			
	# 2	∅	48
			
			

X374320			
	# 2	∅	48
			
			



X374321			
	# 3	∅	40/57
			
			441457



X374322			
	# 3	∅	40/57
			
			441457



X374323			
	# 2	∅	48
			
			

X374324			
	# 2	∅	48
			
			

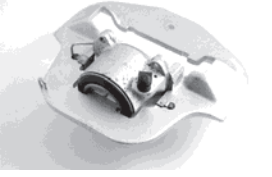

X374327			
	# 2	∅	48
			
			

X374328			
	# 2	∅	48
			
			

X374333			
	# 2	∅	54
			
			441143



X374334			
	# 2	∅	54
			
			441143



X374337			
	# 2	∅	44
			
			

X374338			
	# 2	∅	44
			
			

X374339			
	# 2	∅	54
			
			441143

X374340			
	# 2	∅	54
			
			441143

X374341			
	# 2	∅	48
			
			

X374342			
	# 2	∅	48
			
			



X374343				
	#	1	∅	54
	441195			

X374344				
	#	1	∅	54
	441195			

X374349				
	#	2	∅	54
	441143			

X374350				
	#	2	∅	54
	441143			

X374351				
	#	2	∅	54
	441143			

X374352				
	#	2	∅	54
	441143			

X374353				
	#	1	∅	54
	441195			

X374354				
	#	1	∅	54
	441195			

X374359				
	#	1	∅	54
	441195			

X374360				
	#	1	∅	54
	441195			

X374361				
	#	2	∅	40/45
	441996			

X374362				
	#	2	∅	40/45
	441996			

X374363				
	#	2	∅	60
	441919			

X374364				
	#	2	∅	60
	441919			

X374365				
	#	1	∅	48
	441663			

X374366				
	#	1	∅	48
	441663			



X374367				
	#	1	∅	54
	441195			

X374368				
	#	1	∅	54
	441195			

X374369				
	#	1	∅	60
	441181			

X374370				
	#	1	∅	60
	441181			

X374371				
	#	1	∅	57
	441638			

X374372				
	#	1	∅	57
	441638			

X374373				
	#	1	∅	57
	441638			

X374374				
	#	1	∅	57
	441638			

X374375				
	#	1	∅	60
	441181			

X374376				
	#	1	∅	60
	441181			

X374377				
	#	1	∅	54
	441195			

X374378				
	#	1	∅	54
	441195			

X374379				
	#	1	∅	57
	441773			

X374380				
	#	1	∅	57
	441773			

X374381				
	#	1	∅	57
	441773			

X374382				
	#	1	∅	57
	441773			



X374383				
	#	1	∅	54
	441195			

X374384				
	#	1	∅	54
	441195			

X374385				
	#	2	∅	43
	441789			

X374386				
	#	2	∅	43
	441789			

X374391				
	#	1	∅	54
	441525			

X374392				
	#	1	∅	54
	441525			

X374393				
	#	2	∅	43
	441665			

X374394				
	#	2	∅	43
	441665			

X374395				
	#	1	∅	68
	441155			

X374396				
	#	1	∅	68
	441155			

X374397				
	#	1	∅	54
	441195			

X374398				
	#	1	∅	54
	441195			



X374399				
	#	1	∅	54
	441891			



X374400				
	#	1	∅	54
	441891			



X374401				
	#	1	∅	54
	441891			

X374402				
	#	1	∅	54
	441891			









X374403			
	# 1	∅	54
			
	441725		



X374404			
	# 1	∅	54
			
	441725		



X374405			
	# 1	∅	54
			
	441725		



X374406			
	# 1	∅	54
			
	441725		



X374407			
	# 2	∅	43
			
	441789		



X374408			
	# 2	∅	43
			
	441789		

X374409			
	# 1	∅	54
			
	441195		



X374410			
	# 1	∅	54
			
	441195		



X374411			
	# 1	∅	57
			
	441649		



X374412			
	# 1	∅	57
			
	441649		



X374413			
	# 2	∅	54
			
	441628		

X374414			
	# 2	∅	54
			
	441628		



X374415			
	# 1	∅	57
			
	441700		

X374416			
	# 1	∅	57
			
	441700		



X374417			
	# 1	∅	57
			
	441700		



X374418			
	# 1	∅	57
			
	441700		









X374419			
	#	1	∅ 54
			
	441891		

X374420			
	#	1	∅ 54
			
	441891		

X374421			
	#	4	∅ 48
			
	441744		



X374422			
	#	4	∅ 48
			
	441744		



X374423			
	#	2	∅ 43
			
	441665		



X374424			
	#	2	∅ 43
			
	441665		



X374425			
	#	1	∅ 54
			
	441195		

X374426			
	#	1	∅ 54
			
	441195		

X374427			
	#	1	∅ 54
			
	441195		



X374428			
	#	1	∅ 54
			
	441195		



X374431			
	#	1	∅ 54
			
	441992		

X374432			
	#	1	∅ 54
			
	441992		



X374433			
	#	1	∅ 54
			
	441992		



X374434			
	#	1	∅ 54
			
	441992		

X374435			
	#	1	∅ 54
			
	441195		



X374436			
	#	1	∅ 54
			
	441195		









X374437			
	# 3	∅ 34/48	
			
	441458		



X374438			
	# 3	∅ 34/48	
			
	441458		



X374439			
	# 2	∅ 48	
			
	442065		

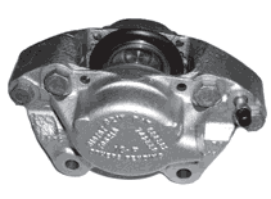

X374440			
	# 2	∅ 48	
			
	442065		

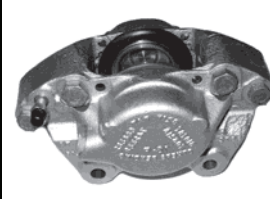

X374441			
	# 4	∅ 34/43	
			
			



X374442			
	# 4	∅ 34/43	
			
			



X374445			
	# 2	∅ 54	
			
	441143		



X374446			
	# 2	∅ 54	
			
	441143		



X374447			
	# 1	∅ 54	
			
	441891		



X374448			
	# 1	∅ 54	
			
	441891		



X374449			
	# 2	∅ 43	
			
	441665		

X374450			
	# 2	∅ 43	
			
	441665		

X374451			
	# 2	∅ 54	
			
			

X374452			
	# 2	∅ 54	
			
			

X374453			
	# 2	∅ 40/45	
			
	442152		

X374454			
	# 2	∅ 40/45	
			
	442152		



X374457				
	#	2	∅	54

X374458				
	#	2	∅	54

X374459				
	#	2	∅	54

X374460				
	#	2	∅	54

X374461				
	#	3	∅	40/57

X374462				
	#	3	∅	40/57

X374463				
	#	1	∅	51
	441959			

X374464				
	#	1	∅	51
	441959			

X374465				
	#	1	∅	48
	441465			

X374466				
	#	1	∅	48
	441465			

X374467				
	#	3	∅	43/60



X374468				
	#	3	∅	43/60

X374469				
	#	1	∅	54
	441195			



X374470				
	#	1	∅	54
	441195			



X374471				
	#	1	∅	48
	441465			



X374472				
	#	1	∅	48
	441465			



X374481			
	# 1	∅	48
			
	441151		

X374482			
	# 1	∅	48
			
	441151		

X374491			
	# 1	∅	54
			
	441195		

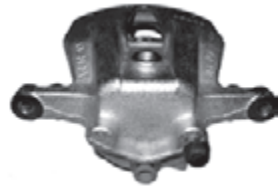

X374492			
	# 1	∅	54
			
	441195		



X374503			
	# 1	∅	54
			
	442062		



X374504			
	# 1	∅	54
			
	442062		



X374507			
	# 2	∅	40/45
			
	441996		



X374508			
	# 2	∅	40/45
			
	441996		

X374517			
	# 1	∅	48
			
	442051		



X374518			
	# 1	∅	48
			
	442051		



X374519			
	# 1	∅	48
			
	442051		

X374520			
	# 1	∅	48
			
	442051		

X374521			
	# 1	∅	54
			
	442073		

X374522			
	# 1	∅	54
			
	442073		

X374527			
	# 1	∅	54
			
	441195		

X374528			
	# 1	∅	54
			
	441195		



X374535				
	#	1	∅	57
	441700			

X374536				
	#	1	∅	57
	441700			

X374537				
	#	1	∅	57
	442072			

X374538				
	#	1	∅	57
	442072			

X374569				
	#	1	∅	57
	442144			

X374570				
	#	1	∅	57
	442144			

X374573				
	#	1	∅	48
	442049			

X374574				
	#	1	∅	48
	442049			

X374575				
	#	1	∅	54
	442050			

X374576				
	#	1	∅	54
	442050			

X374577				
	#	1	∅	54
	442073			

X374578				
	#	1	∅	54
	442073			

X374583				
	#	1	∅	57
	442072			

X374584				
	#	1	∅	57
	442072			

X374589				
	#	1	∅	60
	442137			

X374590				
	#	1	∅	60
	442137			



X374591				
	#	1	∅	57
	441470			

X374592				
	#	1	∅	57
	441470			

X374595				
	#	1	∅	54
	441725			

X374596				
	#	1	∅	54
	441725			

X374597				
	#	1	∅	57
	441773			

X374598				
	#	1	∅	57
	441773			

X374599				
	#	2	∅	40/45
	442152			

X374600				
	#	2	∅	40/45
	442152			

X374603				
	#	1	∅	48
	441282			

X374604				
	#	1	∅	48
	441282			

X374605				
	#	1	∅	57
	441773			

X374606				
	#	1	∅	57
	441773			

X374607				
	#	1	∅	57
	441773			

X374608				
	#	1	∅	57
	441773			

X374609				
	#	2	∅	43
	441693			

X374610				
	#	2	∅	43
	441693			



X374615				
	#	1	∅	54
	442073			

X374616				
	#	1	∅	54
	442073			

X374617				
	#	1	∅	57
	441773			

X374618				
	#	1	∅	57
	441773			

X374619				
	#	1	∅	54
	441725			

X374620				
	#	1	∅	54
	441725			

X374621				
	#	1	∅	57
	442061			

X374622				
	#	1	∅	57
	442061			

X374623				
	#	1	∅	57
	442061			

X374624				
	#	1	∅	57
	442061			

X374625				
	#	1	∅	54
	441195			

X374626				
	#	1	∅	54
	441195			



X374627				
	#	2	∅	48
	441195			



X374628				
	#	2	∅	48
	441195			



X374631				
	#	1	∅	54
	441725			



X374632				
	#	1	∅	54
	441725			









X374633			
	# 1	∅	54
			
	441725		



X374634			
	# 1	∅	54
			
	441725		



X374635			
	# 1	∅	57
			
	441773		

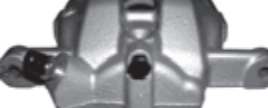

X374636			
	# 1	∅	57
			
	441773		

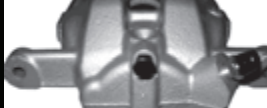

X374637			
	# 1	∅	48
			
	442049		



X374638			
	# 1	∅	48
			
	442049		



X374639			
	# 1	∅	54
			
	442050		



X374640			
	# 1	∅	54
			
	442050		



X374645			
	# 1	∅	60
			
	442137		



X374646			
	# 1	∅	60
			
	442137		



X374647			
	# 2	∅	45
			
	442136		

X374648			
	# 2	∅	45
			
	442136		

X374649			
	# 1	∅	54
			
	441725		

X374650			
	# 1	∅	54
			
	441725		



X374651			
	# 2	∅	43
			
	441789		



X374652			
	# 2	∅	43
			
	441789		









X374653			
	# 1	∅	57
			
	441732		



X374654			
	# 1	∅	57
			
	441732		



X374657			
	# 1	∅	57
			
	441732		

X374658			
	# 1	∅	57
			
	441732		

X374661			
	# 2	∅	45/58
			
	441733		



X374662			
	# 2	∅	45/58
			
	441733		

X374663			
	# 2	∅	45/48
			
	441733		



X374664			
	# 2	∅	45/48
			
	441733		



X374665			
	# 2	∅	38/45
			
	442194		



X374666			
	# 2	∅	38/45
			
	442194		



X374667			
	# 1	∅	54
			
	441725		

X374668			
	# 1	∅	54
			
	441725		



X374669			
	# 1	∅	57
			
			



X374670			
	# 1	∅	57
			
			



X374671			
	# 1	∅	54
			
	441725		



X374672			
	# 1	∅	54
			
	441725		





X374675			
	# 1	∅	57
			
	441615		

X374676			
	# 1	∅	57
			
	441615		



X374681			
	# 1	∅	54
			
	442050		



X374682			
	# 1	∅	54
			
	442050		

X374691			
	# 2	∅	42
			
	441612		



X374692			
	# 2	∅	42
			
	441612		



X374695			
	# 1	∅	66
			
	441674		



X374696			
	# 1	∅	66
			
	441674		



X374699			
	# 2	∅	40/45
			
	442152		



X374700			
	# 2	∅	40/45
			
	442152		



X374701			
	# 4	∅	43
			
	441190		

X374702			
	# 4	∅	43
			
	441190		



X374705			
	# 1	∅	54
			
			



X374706			
	# 1	∅	54
			
			



X374707			
	# 1	∅	54
			
	441725		



X374708			
	# 1	∅	54
			
	441725		









X374711				
	#	1	∅	66
				
	442289			



X374712				
	#	1	∅	66
				
	442289			



X374713				
	#	1	∅	54
				
	441655			



X374714				
	#	1	∅	54
				
	441655			



X374715				
	#	1	∅	57
				
	441773			



X374716				
	#	1	∅	57
				
	441773			



X374719				
	#	1	∅	57
				
	441773			

X374720				
	#	1	∅	57
				
	441773			

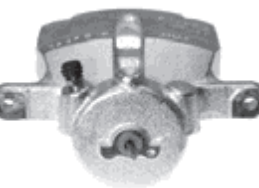

X374725				
	#	1	∅	60
				
	441610			



X374726				
	#	1	∅	60
				
	441610			

X374727				
	#	1	∅	57
				
	441732			

X374728				
	#	1	∅	57
				
	441732			



X374729				
	#	1	∅	66
				
	441674			



X374730				
	#	1	∅	66
				
	441674			

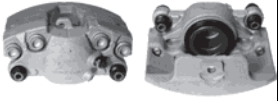

X374731				
	#	1	∅	66
				
	441674			

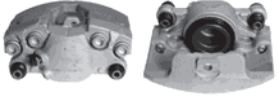

X374732				
	#	1	∅	66
				
	441674			



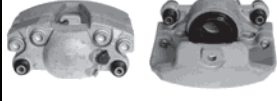



X374733				
	#	1	∅	60
				
	441619			

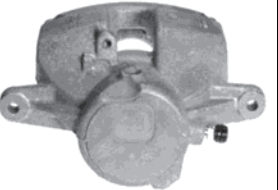

X374734				
	#	1	∅	60
				
	441619			

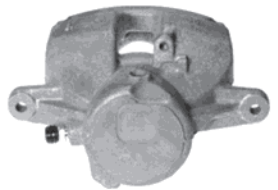

X374735				
	#	1	∅	60
				
	441619			

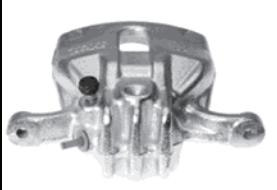

X374736				
	#	1	∅	60
				
	441619			



X374739				
	#	1	∅	60
				
	441616			

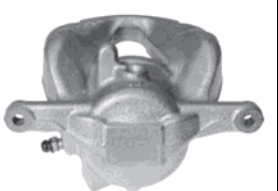

X374740				
	#	1	∅	60
				
	441616			



X374747				
	#	1	∅	57
				
				



X374748				
	#	1	∅	57
				
				

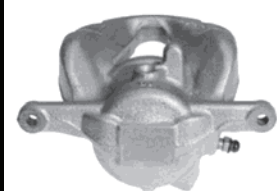

X374749				
	#	1	∅	60
				
	441616			



X374750				
	#	1	∅	60
				
	441616			



X374751				
	#	1	∅	60
				
	441616			

X374752				
	#	1	∅	60
				
	441616			

X374753				
	#	1	∅	60
				
	441616			

X374754				
	#	1	∅	60
				
	441616			

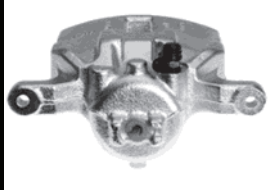
X374755				
	#	1	∅	54
				
	442433			

X374756				
	#	1	∅	54
				
	442433			



X374757				
	#	2	∅	43

X374758				
	#	2	∅	43

X375001				
	#	2	∅	36
	441660			

X375002				
	#	2	∅	36
	441660			

X375003				
	#	1	∅	36
	441167			

X375004				
	#	1	∅	36
	441167			

X375005				
	#	1	∅	38
	441205			

X375006				
	#	1	∅	38
	441205			

X375007				
	#	2	∅	38
	442105			

X375008				
	#	2	∅	38
	442105			

X375009				
	#	2	∅	38
	441218			

X375010				
	#	2	∅	38
	441218			



X375011				
	#	1	∅	43
	441220			



X375012				
	#	1	∅	43
	441220			



X375013				
	#	2	∅	27



X375014				
	#	2	∅	27



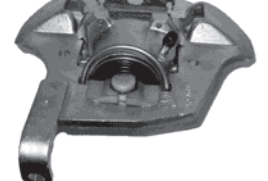





X375015				
	#	2	∅	43
				
	441157			

X375016				
	#	2	∅	43
				
	441157			

X375017				
	#	2	∅	43
				
	441157			

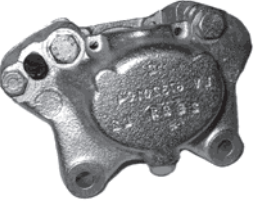

X375018				
	#	2	∅	43
				
	441157			

X375019				
	#	2	∅	38
				
	441218			

X375020				
	#	2	∅	38
				
	441218			



X375021				
	#	1	∅	36
				
	441167			

X375022				
	#	1	∅	36
				
	441167			

X375023				
	#	1	∅	43
				
	442008			

X375024				
	#	1	∅	43
				
	442008			



X375025				
	#	1	∅	36
				
	441167			

X375026				
	#	1	∅	36
				
	441167			



X375027				
	#	1	∅	36
				
	441167			



X375028				
	#	1	∅	36
				
	441167			

X375029				
	#	1	∅	38
				
	441929			

X375030				
	#	1	∅	38
				
	441929			









X375031			
	#	1	∅ 38
			
	441205		

X375032			
	#	1	∅ 38
			
	441205		

X375033			
	#	1	∅ 34
			
	441464		



X375034			
	#	1	∅ 34
			
	441464		



X375035			
	#	1	∅ 36
			
	441167		

X375036			
	#	1	∅ 36
			
	441167		

X375041			
	#	1	∅ 38
			
	441205		



X375042			
	#	1	∅ 38
			
	441205		



X375045			
	#	1	∅ 38
			
	441205		



X375046			
	#	1	∅ 38
			
	441205		



X375047			
	#	1	∅ 38
			
	441905		

X375048			
	#	1	∅ 38
			
	441905		



X375049			
	#	1	∅ 38
			
	441905		



X375050			
	#	1	∅ 38
			
	441205		

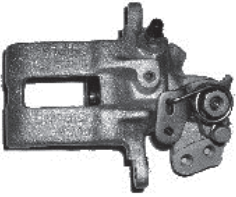

X375051			
	#	1	∅ 38
			
	441905		

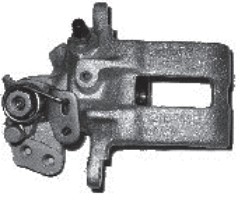

X375052			
	#	1	∅ 38
			
	441905		









X375053			
	#	1	∅ 38
			
	441856		

X375054			
	#	1	∅ 38
			
	441856		

X375059			
	#	1	∅ 34
			
	441464		



X375060			
	#	1	∅ 34
			
	441464		



X375061			
	#	1	∅ 36
			
			

X375062			
	#	1	∅ 36
			
			

X375063			
	#	1	∅ 38
			
	441905		



X375064			
	#	1	∅ 38
			
	441905		



X375065			
	#	1	∅ 40
			
	441905		

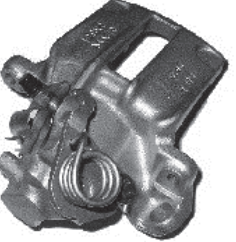

X375066			
	#	1	∅ 40
			
	441905		



X375067			
	#	1	∅ 43
			
	441220		

X375068			
	#	1	∅ 43
			
	441220		

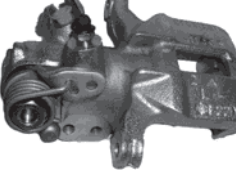
X375079			
	#	1	∅ 43
			
	441220		

X375080			
	#	1	∅ 43
			
	441220		

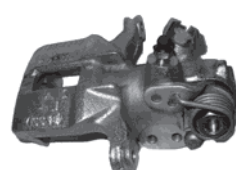

X375081			
	#	1	∅ 30
			
	441893		



X375082			
	#	1	∅ 30
			
	441893		



X375083			
	# 1	∅	34
			
	441940		



X375084			
	# 1	∅	34
			
	441940		



X375085			
	# 1	∅	38
			
	441905		



X375086			
	# 1	∅	38
			
	441905		



X375087			
	# 1	∅	38
			
	441905		

X375088			
	# 1	∅	38
			
	441905		



X375089			
	# 1	∅	34
			
	441859		

X375090			
	# 1	∅	34
			
	441859		



X375091			
	# 1	∅	34
			
	441755		

X375092			
	# 1	∅	34
			
	441755		



X375095			
	# 1	∅	34
			
	442209		

X375096			
	# 1	∅	34
			
	442209		

X375097			
	# 2	∅	43
			
	441157		

X375098			
	# 2	∅	43
			
	441157		



X375099			
	# 2	∅	43
			
	441157		



X375100			
	# 2	∅	43
			
	441157		



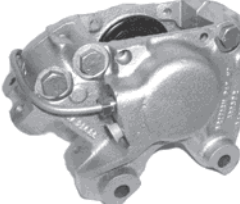



X375101			
	# 1	∅	30
			
	441194		



X375102			
	# 1	∅	30
			
	441194		



X375107			
	# 2	∅	43
			
	441896		

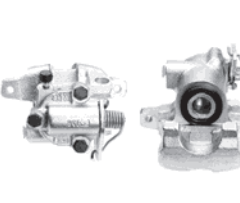

X375108			
	# 2	∅	43
			
	441896		

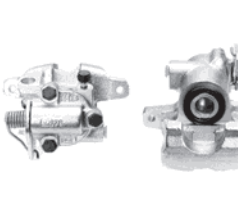

X375111			
	# 1	∅	-
			
			

X375112			
	# 1	∅	-
			
			

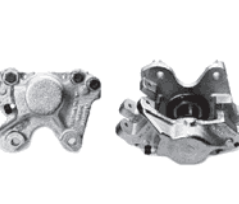
X375115			
	# 1	∅	36
			
			

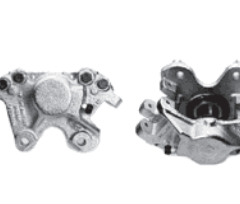

X375116			
	# 1	∅	36
			
			



X375117			
	# 2	∅	43
			
	441896		



X375118			
	# 2	∅	43
			
	441896		



X375121			
	# 1	∅	30
			
	441771		

X375122			
	# 1	∅	30
			
	441771		



X375123			
	# 1	∅	38
			
	441905		



X375124			
	# 1	∅	38
			
	441905		

X375125			
	# 1	∅	36
			
	441167		

X375126			
	# 1	∅	36
			
	441167		









X375129			
	# 1	∅ 38	
			
	441205		



X375130			
	# 1	∅ 38	
			
	441205		



X375131			
	# 1	∅ 43	
			
	442008		

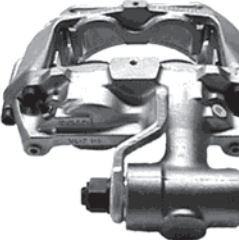

X375132			
	# 1	∅ 43	
			
	442008		



X375133			
	# 1	∅ 38	
			
	441905		



X375134			
	# 1	∅ 38	
			
	441905		

X375135			
	# 2	∅ 60	
			
	441811		



X375136			
	# 2	∅ 60	
			
	441811		



X375137			
	# 2	∅ 68	
			
			



X375138			
	# 2	∅ 68	
			
			

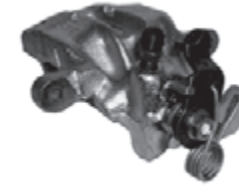

X375139			
	# 1	∅ 43	
			
	442008		

X375140			
	# 1	∅ 43	
			
	442008		



X375141			
	# 1	∅ 38	
			
	441905		



X375142			
	# 1	∅ 38	
			
	441905		



X375143			
	# 1	∅ 38	
			
	441915		



X375144			
	# 1	∅ 38	
			
	441915		









X375145			
	# 1	∅	38
			
	441915		

X375146			
	# 1	∅	38
			
	441915		

X375147			
	# 1	∅	38
			
	441905		



X375148			
	# 1	∅	38
			
	441905		



X375149			
	# 1	∅	34
			
	441859		



X375150			
	# 1	∅	34
			
	441859		



X375151			
	# 1	∅	38
			
	441915		



X375152			
	# 1	∅	38
			
	441915		



X375153			
	# 1	∅	38
			
	441915		

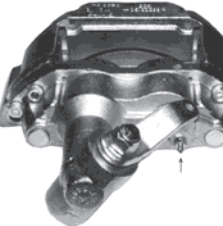

X375154			
	# 1	∅	38
			
	441915		

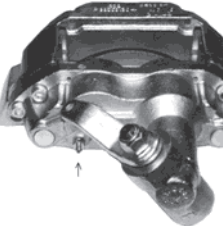

X375155			
	# 1	∅	34
			
	441940		

X375156			
	# 1	∅	34
			
	441940		

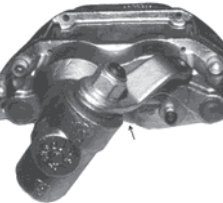
X375157			
	# 2	∅	58
			
			

X375158			
	# 2	∅	58
			
			

X375159			
	# 2	∅	68
			
			

X375160			
	# 2	∅	68
			
			









X375161			
	# 1	∅ 36	
			
	441167		



X375162			
	# 1	∅ 36	
			
	441167		



X375165			
	# 1	∅ 38	
			
	441915		

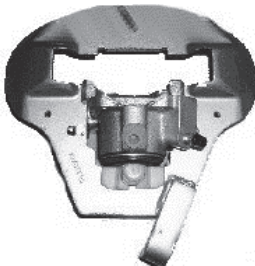

X375166			
	# 1	∅ 38	
			
	441915		

X375167			
	# 1	∅ 45	
			
	441712		

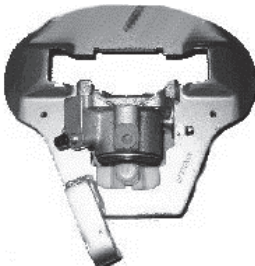

X375168			
	# 1	∅ 45	
			
	441712		

X375169			
	# 2	∅ 43	
			
			



X375170			
	# 2	∅ 43	
			
			



X375173			
	# 1	∅ 38	
			
	441915		



X375174			
	# 1	∅ 38	
			
	441915		



X375177			
	# 4	∅ 40/48	
			
			

X375178			
	# 4	∅ 40/48	
			
			

X375179			
	# 2	∅ 34	
			
			

X375180			
	# 2	∅ 34	
			
			

X375181			
	# 2	∅ 60	
			
	442010		

X375182			
	# 2	∅ 60	
			
	442010		



X375183			
	# 4	∅ 40/48	

X375184			
	# 4	∅ 40/48	

X375189			
	# 1	∅ 43	

X375190			
	# 1	∅ 43	

X375191			
	# 1	∅ 41	
		442090	

X375192			
	# 1	∅ 41	
		442090	

X375193			
	# 1	∅ 41	
		442090	

X375194			
	# 1	∅ 41	
		442090	

X375197			
	# 1	∅ 41	
		442090	

X375198			
	# 1	∅ 41	
		442090	

X375203			
	# 1	∅ 38	
		441915	

X375204			
	# 1	∅ 38	
		441915	

X375213			
	# 1	∅ 43	
		442321	

X375214			
	# 1	∅ 43	
		442321	

X375215			
	# 1	∅ 38	
		441915	

X375216			
	# 1	∅ 38	
		441915	



X375217				
	#	1	∅	34
	441940			

X375218				
	#	1	∅	34
	441940			

X375221				
	#	2	∅	60
	442010			

X375222				
	#	2	∅	60
	442010			

X375231				
	#	1	∅	38
	441856			

X375232				
	#	1	∅	38
	441856			

X375233				
	#	1	∅	38
	441915			

X375234				
	#	1	∅	38
	441915			

X375237				
	#	1	∅	38
	441915			

X375238				
	#	1	∅	38
	441915			

X375239				
	#	1	∅	38
	442084			

X375240				
	#	1	∅	38
	442084			

X375241				
	#	1	∅	34
	442089			

X375242				
	#	1	∅	34
	442089			

X375245				
	#	1	∅	38
	441915			

X375246				
	#	1	∅	38
	441915			



X375247			
	#	1	∅ 38
	441915		

X375248			
	#	1	∅ 38
	441915		

X375251			
	#	1	∅ 38
	441915		

X375252			
	#	1	∅ 38
	441915		

X375253			
	#	1	∅ 34
	442006		

X375254			
	#	1	∅ 34
	442006		

X375255			
	#	1	∅ 38
	441915		

X375256			
	#	1	∅ 38
	441915		

X375257			
	#	1	∅ 36
	442027		

X375258			
	#	1	∅ 36
	442027		

X375259			
	#	1	∅ 41
	442090		

X375260			
	#	1	∅ 41
	442090		



X375265			
	#	1	∅ 34
	442089		

X375266			
	#	1	∅ 34
	442089		



X375267			
	#	1	∅ 38
	441915		

X375268			
	#	1	∅ 38
	441915		







X375271			
	#	1	∅ 34
			
	442006		

X375272			
	#	1	∅ 34
			
	442006		

X375273			
	#	1	∅ 38
			
	442170		



X375274			
	#	1	∅ 38
			
	442170		



X375275			
	#	1	∅ 38
			
	441915		

X375276			
	#	1	∅ 38
			
	441915		

X375281			
	#	1	∅ 34
			
	441940		



X375282			
	#	1	∅ 34
			
	441940		

X375289			
	#	1	∅ 34
			
	441940		



X375290			
	#	1	∅ 34
			
	441940		

X375291			
	#	1	∅ 38
			
	441915		

X375292			
	#	1	∅ 38
			
	441915		



X375293			
	#	1	∅ 38
			
	441915		



X375294			
	#	1	∅ 38
			
	441915		

X375295			
	#	1	∅ 38
			
	441915		

X375296			
	#	1	∅ 38
			
	441915		









X375299			
	# 1	∅ 34	
			
	442089		

X375300			
	# 1	∅ 34	
			
	442089		

X375301			
	# 1	∅ 34	
			
	442089		



X375302			
	# 1	∅ 34	
			
	442089		

X375303			
	# 1	∅ 36	
			
	442027		

X375304			
	# 1	∅ 36	
			
	442027		

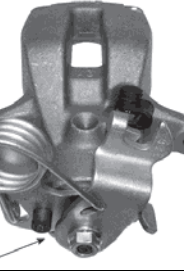

X375305			
	# 1	∅ 38	
			
	442084		



X375306			
	# 1	∅ 38	
			
	442084		



X375309			
	# 1	∅ 43	
			
	442255		



X375310			
	# 1	∅ 43	
			
	442255		



X375313			
	# 1	∅ 41	
			
	442090		

X375314			
	# 1	∅ 41	
			
	442090		

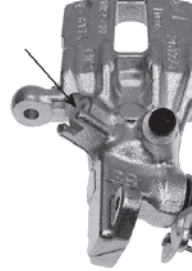
X375315			
	# 1	∅ 41	
			
	442090		

X375316			
	# 1	∅ 41	
			
	442090		

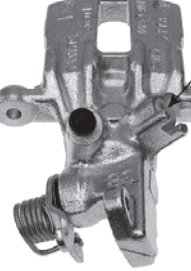
X375321			
	# 1	∅ 38	
			
	441741		

X375322			
	# 1	∅ 38	
			
	441741		



X375325				
	#	1	∅	40
	442239			

X375326				
	#	1	∅	40
	442239			

X375329				
	#	1	∅	41
	442090			

X375330				
	#	1	∅	41
	442090			

X375331				
	#	1	∅	45
	441484			

X375332				
	#	1	∅	45
	441484			

X375333				
	#	1	∅	38
	441915			

X375334				
	#	1	∅	38
	441915			

X375337				
	#	1	∅	34
	441940			

X375338				
	#	1	∅	34
	441940			

X375339				
	#	1	∅	43
	442255			

X375340				
	#	1	∅	43
	442255			



X375341				
	#	1	∅	41
	442090			



X375342				
	#	1	∅	41
	442090			



X375343				
	#	1	∅	34
	441940			



X375344				
	#	1	∅	34
	441940			





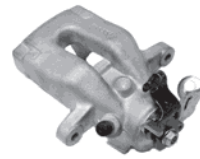

X375345			
	#	1	∅ 34
			
	442210		



X375346			
	#	1	∅ 34
			
	442210		



X375347			
	#	1	∅ 38
			
	441915		



X375348			
	#	1	∅ 38
			
	441915		



X375349			
	#	1	∅ 38
			
	441915		

X375350			
	#	1	∅ 38
			
	441915		



X375351			
	#	1	∅ 28
			
	442237		



X375352			
	#	1	∅ 28
			
	442237		



X375353			
	#	1	∅ 38
			
	441915		



X375354			
	#	1	∅ 38
			
	441915		



X375355			
	#	1	∅ 38
			
	441915		

X375356			
	#	1	∅ 38
			
	441915		

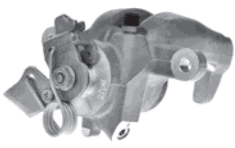

X375357			
	#	1	∅ 38
			
	441223		



X375358			
	#	1	∅ 38
			
	441223		



X375359			
	#	1	∅ 38
			
	441915		



X375360			
	#	1	∅ 38
			
	441915		



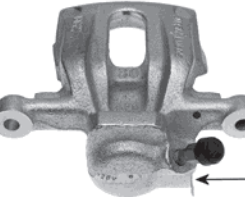

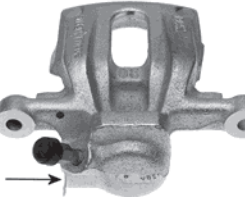

X375361			
	# 1	∅ 38	
			
	441915		

X375362			
	# 1	∅ 38	
			
	441915		

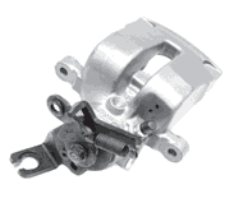
X375363			
	# 1	∅ 30	
			
	441474		



X375364			
	# 1	∅ 30	
			
	441474		



X375365			
	# 1	∅ 38	
			
	441915		



X375366			
	# 1	∅ 38	
			
	441915		



X375367			
	# 1	∅ 41	
			
	442090		



X375368			
	# 1	∅ 41	
			
	442090		



X375369			
	# 1	∅ 34	
			
	442006		

X375370			
	# 1	∅ 34	
			
	442006		



X375371			
	# 1	∅ 38	
			
	441915		

X375372			
	# 1	∅ 38	
			
	441915		

X375377			
	# 1	∅ 38	
			
	441915		

X375378			
	# 1	∅ 38	
			
	441915		

X375379			
	# 1	∅ 41	
			
	442090		

X375380			
	# 1	∅ 41	
			
	442090		



X375381				
	#	1	∅	30
	441474			

X375382				
	#	1	∅	30
	441474			

X375383				
	#	1	∅	36
	441478			

X375384				
	#	1	∅	36
	441478			

X375385				
	#	1	∅	34
	441940			

X375386				
	#	1	∅	34
	441940			

X375389				
	#	1	∅	41
	442090			

X375390				
	#	1	∅	41
	442090			

X375391				
	#	1	∅	43
	442255			

X375392				
	#	1	∅	43
	442255			

X375393				
	#	1	∅	34
	441695			

X375394				
	#	1	∅	34
	441695			



X375395				
	#	1	∅	38
	441915			



X375396				
	#	1	∅	38
	441915			



X375397				
	#	1	∅	38
	441915			

X375398				
	#	1	∅	38
	441915			

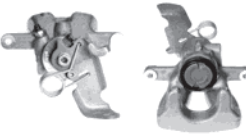







X375399				
	#	1	∅	41
				
	442090			

X375400				
	#	1	∅	41
				
	442090			

X375401				
	#	1	∅	43
				
	442321			



X375402				
	#	1	∅	43
				
	442321			



X375403				
	#	1	∅	38
				
	441915			

X375404				
	#	1	∅	38
				
	441915			

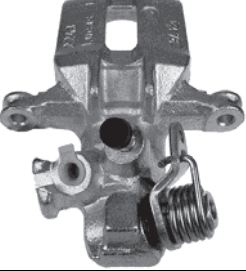
X375405				
	#	1	∅	41
				
	442090			

X375406				
	#	1	∅	41
				
	442090			

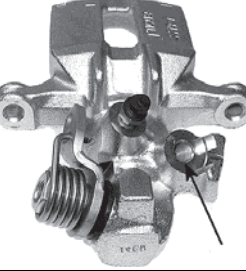
X375409				
	#	1	∅	34
				
	442209			



X375410				
	#	1	∅	34
				
	442209			



X375411				
	#	1	∅	36
				
	442027			

X375412				
	#	1	∅	36
				
	442027			

X375413				
	#	1	∅	38
				
	441915			

X375414				
	#	1	∅	38
				
	441915			

X375415				
	#	1	∅	43
				
				

X375416				
	#	1	∅	43
				
				



X375423				
	#	1	∅	41
		442090		

X375424				
	#	1	∅	41
		442090		

X375425				
	#	1	∅	41
		442090		

X375426				
	#	1	∅	41
		442090		

X375427				
	#	1	∅	41
		442090		

X375428				
	#	1	∅	41
		442090		

X375429				
	#	1	∅	41
		442090		

X375430				
	#	1	∅	41
		442090		

X375431				
	#	1	∅	41
		442090		

X375432				
	#	1	∅	41
		442090		

X375435				
	#	1	∅	48

X375436				
	#	1	∅	48



X375437				
	#	1	∅	38
		441493		



X375438				
	#	1	∅	38
		441493		



X375439				
	#	1	∅	38
		441915		



X375440				
	#	1	∅	38
		441915		



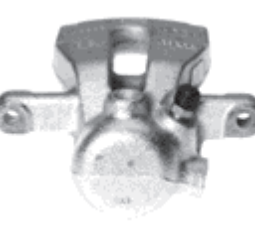



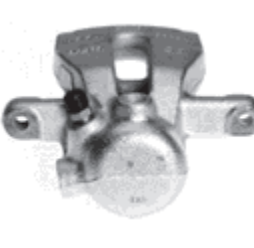

X375445			
	# 1	∅ 34	
			
	441940		



X375446			
	# 1	∅ 34	
			
	441940		



X375447			
	# 1	∅ 38	
			
	441223		

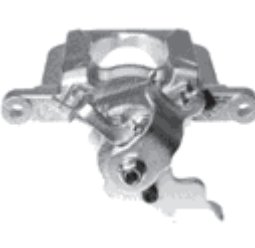

X375448			
	# 1	∅ 38	
			
	441223		

X375449			
	# 1	∅ 34	
			
	442006		

X375450			
	# 1	∅ 34	
			
	442006		



X375451			
	# 1	∅ 43	
			
	442321		



X375452			
	# 1	∅ 43	
			
	442321		



X375453			
	# 1	∅ 38	
			
	441493		



X375454			
	# 1	∅ 38	
			
	441493		



X375455			
	# 1	∅ 38	
			
	441493		

X375456			
	# 1	∅ 38	
			
	441493		



X375457			
	# 1	∅ 38	
			
	441915		



X375458			
	# 1	∅ 38	
			
	441915		



X375459			
	# 1	∅ 38	
			
	441915		



X375460			
	# 1	∅ 38	
			
	441915		







X375463			
	#	1	∅ 45
			
	441484		



X375464			
	#	1	∅ 45
			
	441484		



X375467			
	#	1	∅ 43
			
			



X375468			
	#	1	∅ 43
			
			



X375477			
	#	1	∅ 38
			
	441915		



X375478			
	#	1	∅ 38
			
	441915		



X375507			
	#	1	∅ 41
			
	442090		



X375508			
	#	1	∅ 41
			
	442090		

X377001			
	#	1	∅ 38
			
	441551		



X377001E			
	#	1	∅ 38
			
	441551		

X377002			
	#	1	∅ 38
			
	441551		

X377002E			
	#	1	∅ 38
			
	441551		

X377003			
	#	1	∅ 38
			
	441567		

X377003E			
	#	1	∅ 38
			
	441567		



X377004			
	#	1	∅ 38
			
	441567		

X377004E			
	#	1	∅ 38
			
	441567		





X377005				
	#	1	∅	41
				
	441551			

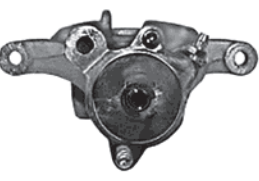

X377005E				
	#	1	∅	41
				
	441551			

X377006				
	#	1	∅	41
				
	441551			



X377006E				
	#	1	∅	41
				
	441551			

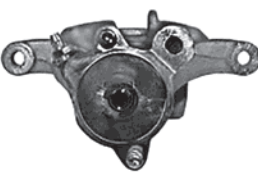

X377007				
	#	1	∅	41
				
	441551			



X377007E				
	#	1	∅	41
				
	441551			

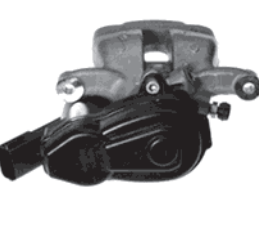

X377008				
	#	1	∅	41
				
	441551			



X377008E				
	#	1	∅	41
				
	441551			

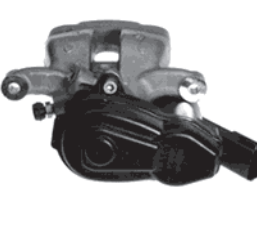

X377009				
	#	1	∅	38
				
	441567			



X377009E				
	#	1	∅	38
				
				

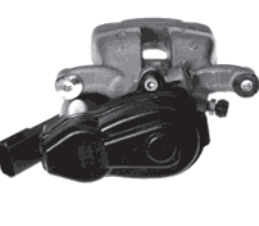

X377010				
	#	1	∅	38
				
	441567			

X377010E				
	#	1	∅	38
				
				



X377011				
	#	1	∅	34
				
				

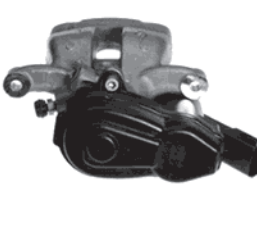

X377011E				
	#	1	∅	34
				
				

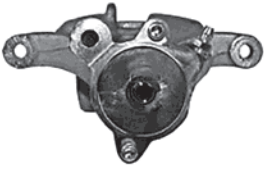

X377012				
	#	1	∅	34
				
				

X377012E				
	#	1	∅	34
				
				

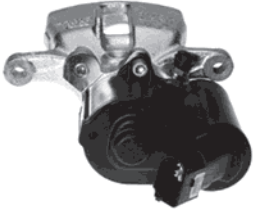

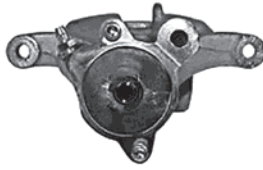

X377013				
	#	1	∅	41
				
	441551			

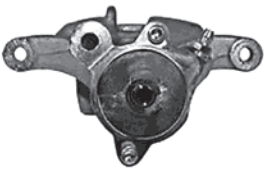

X377013E				
	#	1	∅	41
				
	441551			

X377014				
	#	1	∅	41
				
	441551			

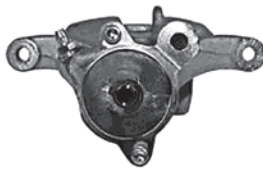

X377014E				
	#	1	∅	41
				
	441551			

X377015				
	#	1	∅	43
				
	441552			



X377015E				
	#	1	∅	43
				
	441552			

X377016				
	#	1	∅	43
				
	441552			



X377016E				
	#	1	∅	43
				
	441552			

X377017				
	#	1	∅	43
				
	441552			

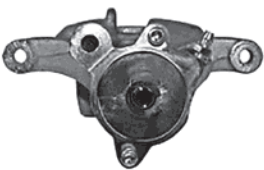

X377017E				
	#	1	∅	43
				
	441552			

X377018				
	#	1	∅	43
				
	441552			

X377018E				
	#	1	∅	43
				
	441552			

X377019				
	#	1	∅	43
				
	441552			

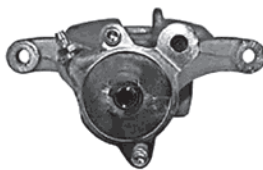
X377019E				
	#	1	∅	43
				
	441552			

X377020				
	#	1	∅	43
				
	441552			

X377020E				
	#	1	∅	43
				
	441552			



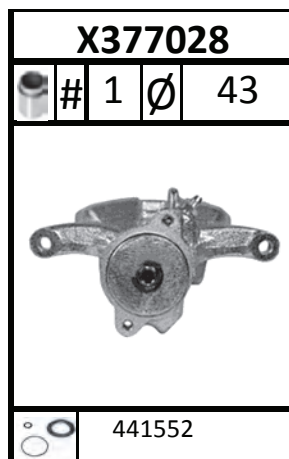
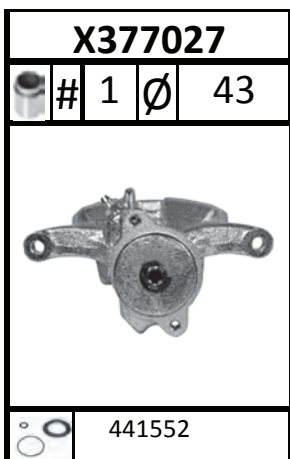
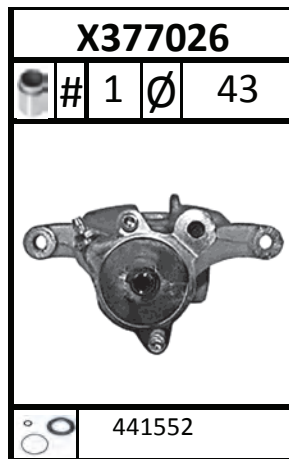
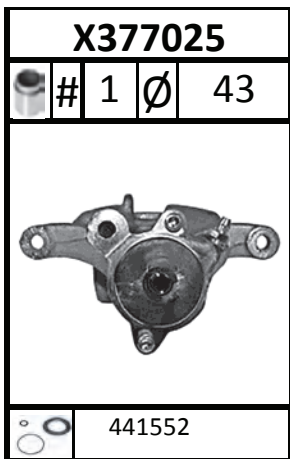
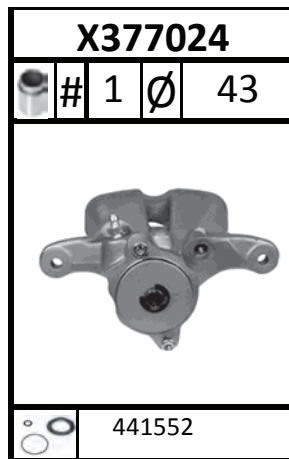
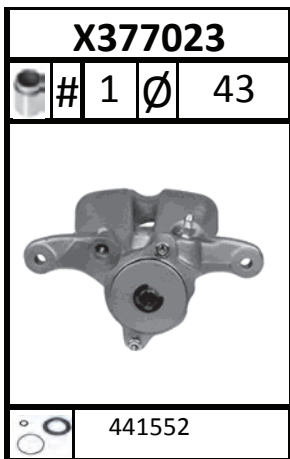
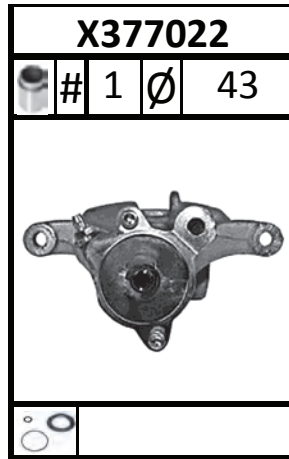
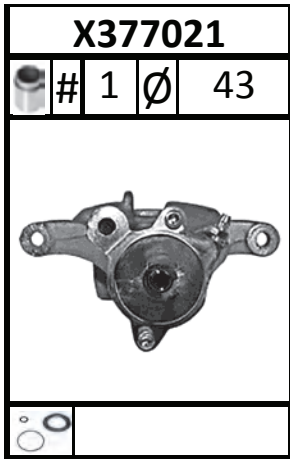

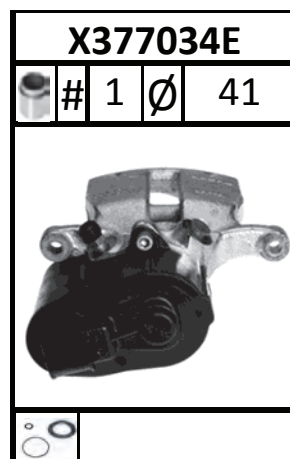
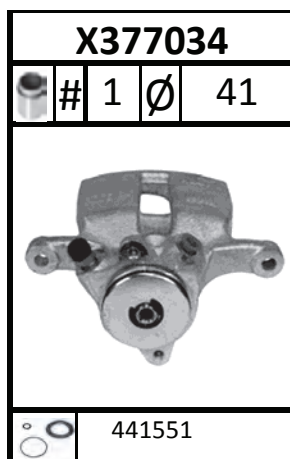
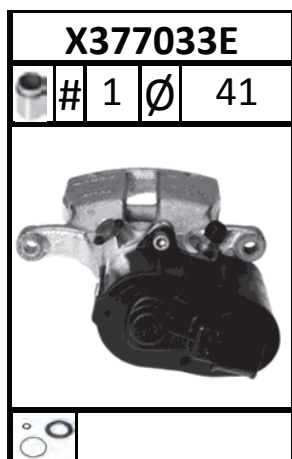
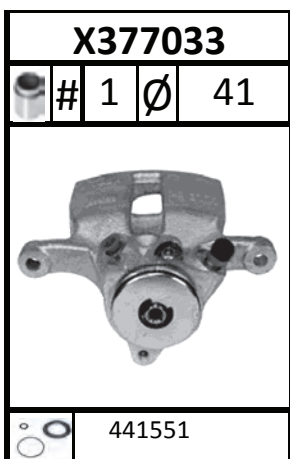
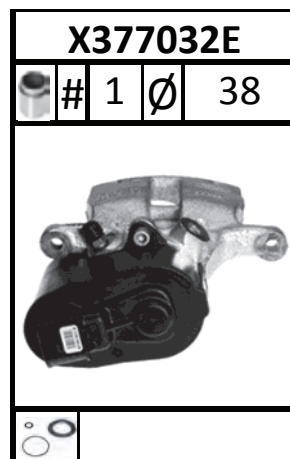
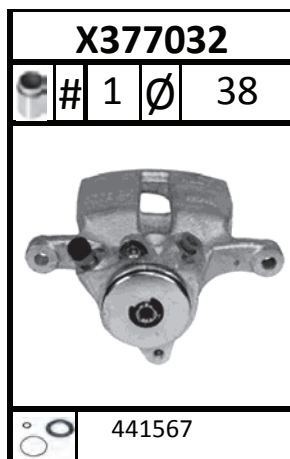
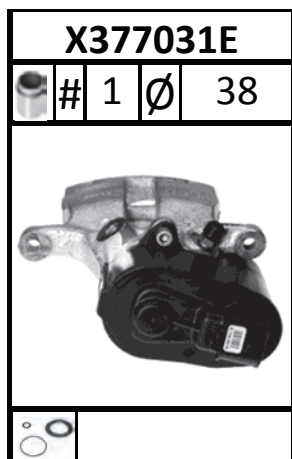
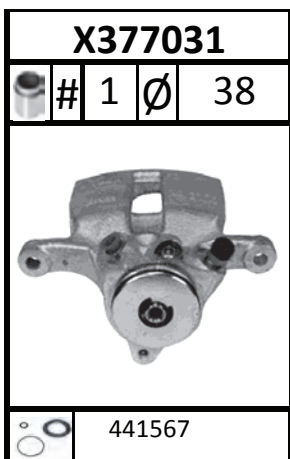
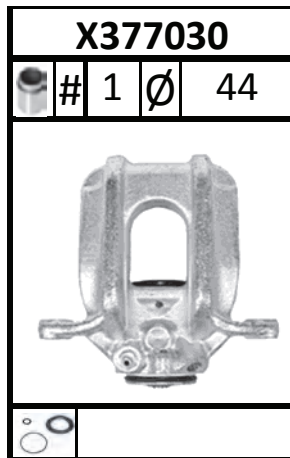
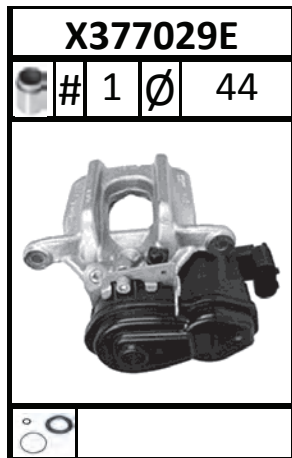
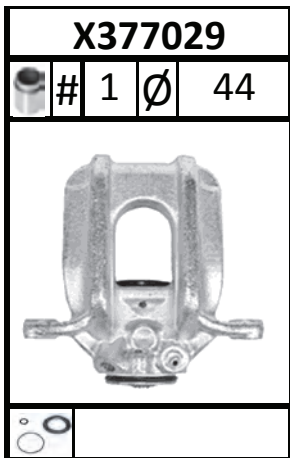

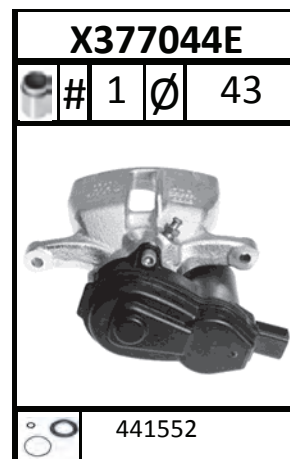
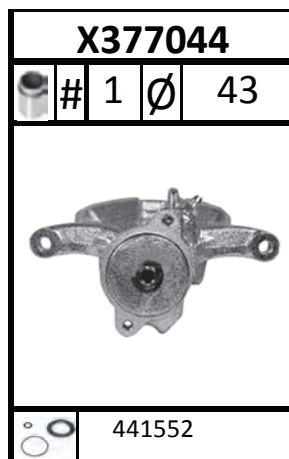
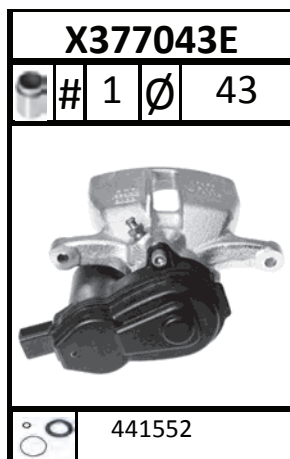
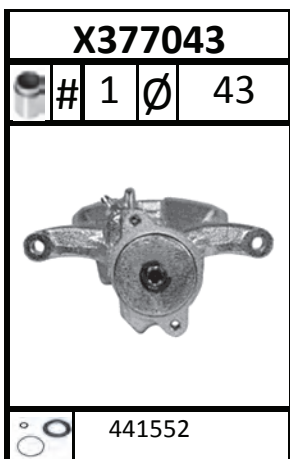
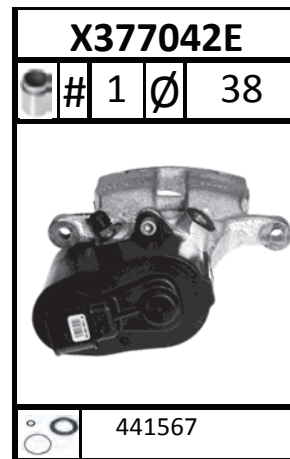
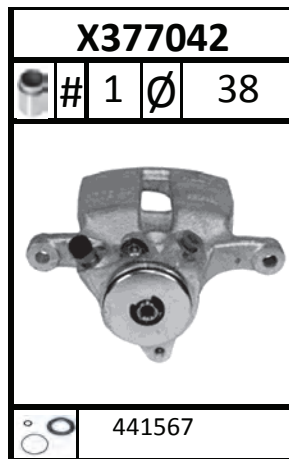
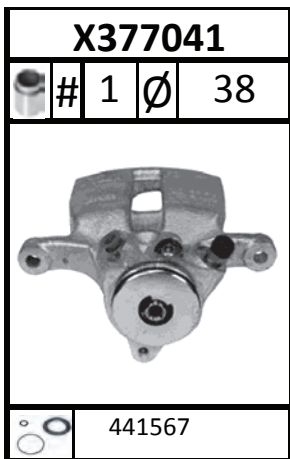
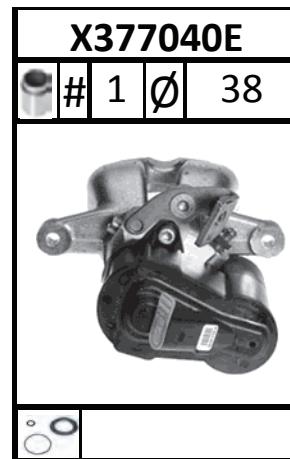
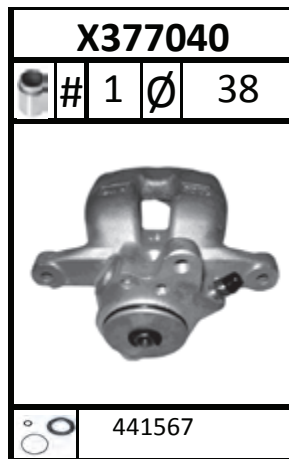
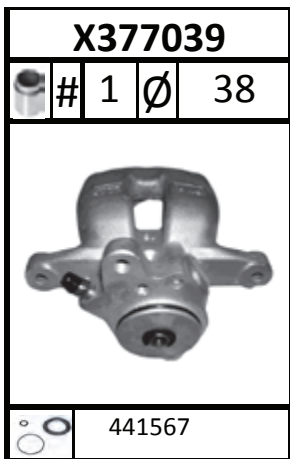
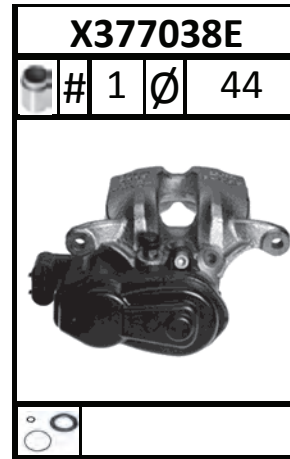
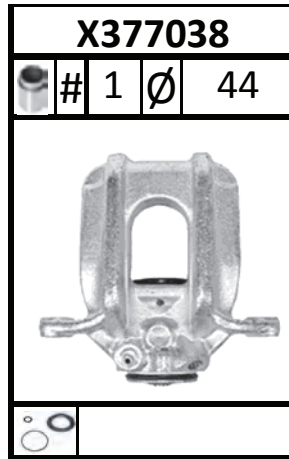
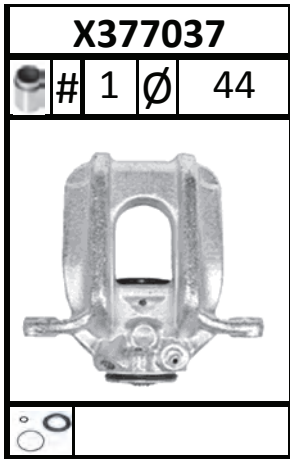

X377045			
	# 1	∅	43
	441552		

X377045E			
	# 1	∅	43
	441552		

X377046			
	# 1	∅	43
	441552		

X377046E			
	# 1	∅	43
	441552		

X377047			
	# 1	∅	43

X377047E			
	# 1	∅	43
	441552		

X377048			
	# 1	∅	43

X377048E			
	# 1	∅	43
	441552		

X377049E			
	# 1	∅	43
	441552		

X377050E			
	# 1	∅	43
	441552		

X384001			
	# 1	∅	57
	441606		

X384002			
	# 1	∅	57
	441606		



X384003			
	# 1	∅	57
	441606		



X384004			
	# 1	∅	57
	441606		



X404001			
	# 1	∅	60
	441794		



X404002			
	# 1	∅	60
	441794		









X404003				
	#	1	∅	60
				
	441794			



X404004				
	#	1	∅	60
				
	441794			



X404005				
	#	1	∅	60
				
	441794			



X404006				
	#	1	∅	60
				
	441794			



X404007				
	#	1	∅	60
				
				



X404008				
	#	1	∅	60
				
	441794			



X404009				
	#	1	∅	60
				
	441794			



X404010				
	#	1	∅	60
				
				



X404011				
	#	1	∅	54
				
	442299			



X404012				
	#	1	∅	54
				
	442299			



X404013				
	#	1	∅	54
				
	442252			

X404014				
	#	1	∅	54
				
	442252			

X404015				
	#	1	∅	60
				
	441618			

X404016				
	#	1	∅	60
				
	441618			

X405001				
	#	1	∅	36
				
	442241			

X405002				
	#	1	∅	36
				
	442241			



X405003				
	#	1	∅	44
	442179			

X405004				
	#	1	∅	44
	442179			

X414001				
	#	1	∅	57

X414002				
	#	1	∅	57

X414003				
	#	1	∅	57
	441491			

X414004				
	#	1	∅	57
	441491			

X414005				
	#	1	∅	51
	441879			

X414006				
	#	1	∅	51
	441879			

X414007				
	#	1	∅	57
	442081			

X414008				
	#	1	∅	57
	442081			

X415001				
	#	1	∅	34
	441935			

X415002				
	#	1	∅	34
	441935			



X434001				
	#	1	∅	48
	441164			



X434002				
	#	1	∅	48
	441164			



X434003				
	#	2	∅	48
	441131			



X434004				
	#	2	∅	48
	441131			



X434005			
	# 3	∅	30
			
	441202		

X434006			
	# 3	∅	30
			
	441202		



X464001			
	# 4	∅	36
			
	441197		



X464002			
	# 4	∅	36
			
	441197		



X464003			
	# 4	∅	41
			
	441463		

X464004			
	# 4	∅	41
			
	441463		

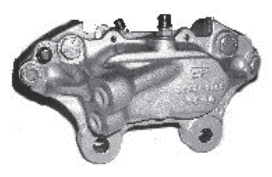

X464005			
	# 4	∅	36
			
	441197		

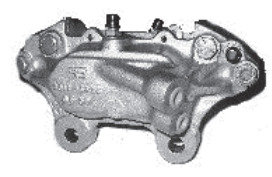

X464006			
	# 4	∅	36
			
	441197		

X464007			
	# 4	∅	38
			
			



X464008			
	# 4	∅	38
			
			

X464009			
	# 1	∅	51
			
	441718		

X464010			
	# 1	∅	51
			
	441718		

X464011			
	# 4	∅	41
			
	441463		

X464012			
	# 4	∅	41
			
	441463		

X464013			
	# 4	∅	41
			
	441463		

X464014			
	# 4	∅	41
			
	441463		



X464015				
	#	4	∅	41

X464016				
	#	4	∅	41

X464017				
	#	2	∅	57
	441201			

X464018				
	#	2	∅	57
	441201			

X464019				
	#	2	∅	57
	441201			

X464020				
	#	2	∅	57
	441201			

X464021				
	#	4	∅	41
	441463			

X464022				
	#	4	∅	41
	441463			

X464025				
	#	2	∅	51
	441132			

X464026				
	#	2	∅	51
	441132			

X464029				
	#	2	∅	57

X464030				
	#	2	∅	57

X464031				
	#	4	∅	41

X464032				
	#	4	∅	41

X464033				
	#	4	∅	41

X464034				
	#	4	∅	41



X464035				
	#	4	∅	41
	441463			

X464036				
	#	4	∅	41
	441463			

X464037				
	#	2	∅	54
	441445			

X464038				
	#	2	∅	54
	441445			

X464039				
	#	4	∅	41
	441463			

X464040				
	#	4	∅	41
	441463			

X464043				
	#	4	∅	41
	441463			

X464044				
	#	4	∅	41
	441463			

X464045				
	#	4	∅	41
	441463			

X464046				
	#	4	∅	41
	441463			

X464047				
	#	4	∅	46
	441640			

X464048				
	#	4	∅	46
	441640			

X464059				
	#	4	∅	46
	441640			

X464060				
	#	4	∅	46
	441640			

X464061				
	#	4	∅	41

X464062				
	#	4	∅	41



X464063				
	#	2	∅	51

X464064				
	#	2	∅	51

X464065				
	#	2	∅	44
		441134		

X464066				
	#	2	∅	44
		441134		

X464067				
	#	2	∅	57
		441201		

X464068				
	#	2	∅	57
		441201		

X464069				
	#	2	∅	51
		441132		

X464070				
	#	2	∅	51
		441132		

X464085				
	#	2	∅	54

X464086				
	#	2	∅	54

X464089				
	#	4	∅	41
		441463		

X464090				
	#	4	∅	41
		441463		



X464091				
	#	4	∅	41
		441463		



X464092				
	#	4	∅	41
		441463		

X464095				
	#	4	∅	46
		441640		

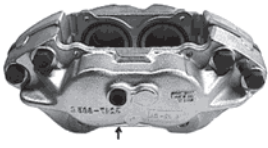
X464096				
	#	4	∅	46
		441640		



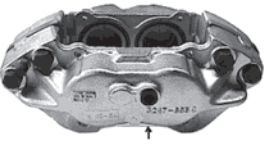





X464097				
	#	4	∅	46
				
	441640			



X464098				
	#	4	∅	46
				
	441640			

X464099				
	#	4	∅	41
				
	441463			

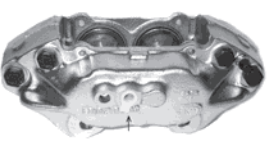

X464100				
	#	4	∅	41
				
	441463			



X464101				
	#	4	∅	46
				
	441640			



X464102				
	#	4	∅	46
				
	441640			



X465001				
	#	2	∅	41
				
	441199			

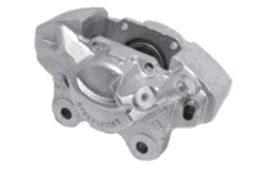

X465002				
	#	2	∅	41
				
	441199			

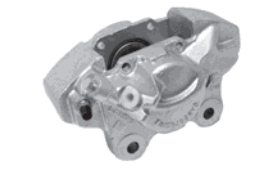

X465003				
	#	2	∅	41
				
	441199			



X465004				
	#	2	∅	41
				
	441199			



X465005				
	#	2	∅	46
				
	441822			

X465006				
	#	2	∅	46
				
	441822			

X465007				
	#	2	∅	41
				
	441199			

X465008				
	#	2	∅	41
				
	441199			

X465009				
	#	2	∅	46
				
	441822			

X465010				
	#	2	∅	46
				
	441822			



X475001				
	#	1	∅	34
	441637			

X475002				
	#	1	∅	34
	441637			

X484001				
	#	1	∅	54
	441738			

X484002				
	#	1	∅	54
	441738			

X484003				
	#	1	∅	51
	441740			

X484004				
	#	1	∅	51
	441740			

X484005				
	#	1	∅	54
	441737			

X484006				
	#	1	∅	54
	441737			

X484007				
	#	1	∅	54
	441737			

X484008				
	#	1	∅	54
	441737			

X484009				
	#	1	∅	57
	441700			

X484010				
	#	1	∅	57
	441700			



X484011				
	#	1	∅	57
	441700			



X484012				
	#	1	∅	57
	441700			

X484013				
	#	1	∅	60
	441803			

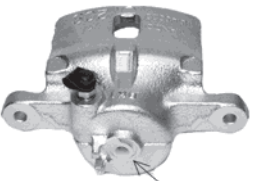
X484014				
	#	1	∅	60
	441803			



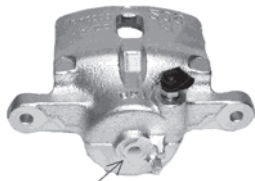





X484015				
	#	1	∅	51
				
	441781			



X484016				
	#	1	∅	51
				
	441781			



X484017				
	#	1	∅	57
				
	441700			



X484018				
	#	1	∅	57
				
	441700			



X484023				
	#	2	∅	43
				
	442214			

X484024				
	#	2	∅	43
				
	442214			

X484025				
	#	1	∅	54
				
	441737			



X484026				
	#	1	∅	54
				
	441737			



X484029				
	#	1	∅	57
				
	441700			



X484030				
	#	1	∅	57
				
	441700			



X484031				
	#	1	∅	57
				
	441700			

X484032				
	#	1	∅	57
				
	441700			

X484033				
	#	2	∅	43
				
	442214			

X484034				
	#	2	∅	43
				
	442214			

X484039				
	#	1	∅	57
				
	441700			

X484040				
	#	1	∅	57
				
	441700			



X484041				
	#	1	∅	57
				441700

X484042				
	#	1	∅	57
				441700

X484043				
	#	1	∅	57
				442145

X484044				
	#	1	∅	57
				442145

X484045				
	#	1	∅	50,8
				441781

X484046				
	#	1	∅	50,8
				441781

X484047				
	#	1	∅	57
				442145

X484048				
	#	1	∅	57
				442145

X484049				
	#	1	∅	60
				442229

X484050				
	#	1	∅	60
				442229

X484051				
	#	2	∅	45
				441483

X484052				
	#	2	∅	45
				441483



X484053				
	#	2	∅	45
				441483



X484054				
	#	2	∅	45
				441483



X484055				
	#	1	∅	54
				442322



X484056				
	#	1	∅	54
				442322









X484057			
	# 1	∅	60
			
	441611		



X484058			
	# 1	∅	60
			
	441611		



X484059			
	# 1	∅	60
			
	441611		



X484060			
	# 1	∅	60
			
	441611		



X484061			
	# 1	∅	50,8
			
	441624		



X484062			
	# 1	∅	50,8
			
	441624		



X484063			
	# 1	∅	54
			
	442322		



X484064			
	# 1	∅	54
			
	442322		



X484065			
	# 2	∅	43
			
	442214		

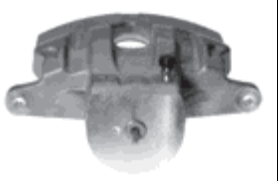

X484066			
	# 2	∅	43
			
	442214		

X484069			
	# 2	∅	43
			
	442214		

X484070			
	# 2	∅	43
			
	442214		



X484071			
	# 1	∅	60
			
	442229		



X484072			
	# 1	∅	60
			
	442229		

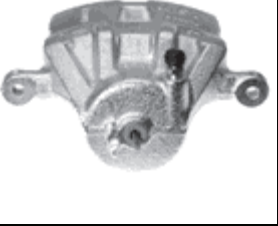

X484073			
	# 1	∅	63,5
			
			

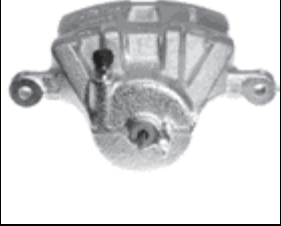

X484074			
	# 1	∅	63,5
			
			







X484075			
	# 1	∅	60
			
	442229		

X484076			
	# 1	∅	60
			
	442229		

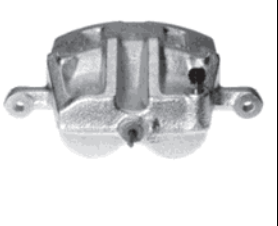
X484077			
	# 2	∅	48
			
			

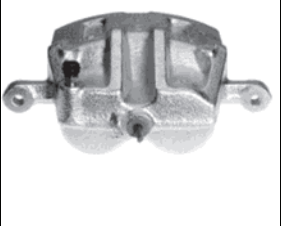

X484078			
	# 2	∅	48
			
			



X484079			
	# 2	∅	43
			
	442432		

X484080			
	# 2	∅	43
			
	442432		

X485001			
	# 1	∅	38
			
	441782		



X485002			
	# 1	∅	38
			
	441782		



X485003			
	# 1	∅	34
			
	445329		



X485004			
	# 1	∅	34
			
	445329		



X485005			
	# 1	∅	34
			
	445329		

X485006			
	# 1	∅	34
			
	445329		



X485007			
	# 1	∅	34
			
	442011		



X485008			
	# 1	∅	34
			
	442011		



X485009			
	# 1	∅	43
			
	442067		



X485010			
	# 1	∅	43
			
	442067		



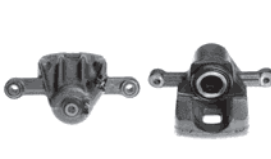



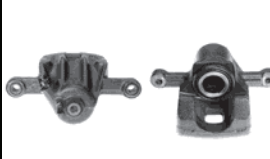

X485011			
	#	1	∅ 38
			
	442066		

X485012			
	#	1	∅ 38
			
	442066		



X485013			
	#	1	∅ 34
			
	442011		



X485014			
	#	1	∅ 34
			
	442011		



X485015			
	#	1	∅ 34
			
	441636		

X485016			
	#	1	∅ 34
			
	441636		



X485017			
	#	1	∅ 43
			
	442067		



X485018			
	#	1	∅ 43
			
	442067		



X485019			
	#	1	∅ 40
			
	441533		



X485020			
	#	1	∅ 40
			
	441533		



X485021			
	#	1	∅ 43
			
	442067		

X485022			
	#	1	∅ 43
			
	442067		

X485023			
	#	1	∅ 34
			
	442011		

X485024			
	#	1	∅ 34
			
	442011		

X485025			
	#	1	∅ 34
			
	442011		

X485026			
	#	1	∅ 34
			
	442011		



X485027				
	#	1	∅	30
	441627			

X485028				
	#	1	∅	30
	441627			

X485029				
	#	1	∅	45
	441629			

X485030				
	#	1	∅	45
	441629			

X485031				
	#	1	∅	34
	441636			

X485032				
	#	1	∅	34
	441636			

X485035				
	#	1	∅	43
	441576			

X485036				
	#	1	∅	43
	441576			

X485037				
	#	1	∅	45
	441629			

X485038				
	#	1	∅	45
	441629			

X485041				
	#	1	∅	34
	441566			

X485042				
	#	1	∅	34
	441566			



X485043				
	#	1	∅	30
	441474			



X485044				
	#	1	∅	30
	441474			



X485045				
	#	1	∅	43
	441576			



X485046				
	#	1	∅	43
	441576			







X487001E			
	# 1	∅ 38	
			
			

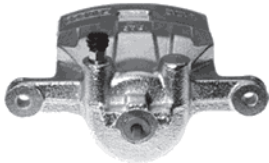

X487002E			
	# 1	∅ 38	
			
			

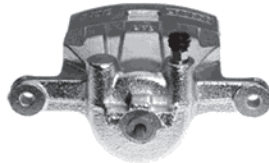

X494003			
	# 1	∅ 57	
			
		442448	



X494004			
	# 1	∅ 57	
			
		442448	



X494005			
	# 1	∅ 54	
			
		441655	

X494006			
	# 1	∅ 54	
			
		441655	

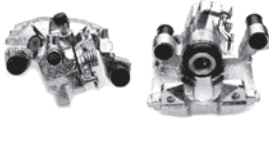
X495001			
	# 1	∅ 43	
			
		442390	

X495002			
	# 1	∅ 43	
			
		442390	

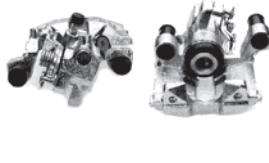
X525001			
	# 1	∅ 30	
			
		441885	

X525002			
	# 1	∅ 30	
			
		441885	



X525003			
	# 1	∅ 41	
			
		441694	

X525004			
	# 1	∅ 41	
			
		441694	

X525005			
	# 1	∅ 41	
			
		441909	

X525006			
	# 1	∅ 41	
			
		441909	

X525007			
	# 1	∅ 30	
			
		441550	

X525008			
	# 1	∅ 30	
			
		441550	



X525009			
	#	1	∅ 30
	441550		

X525010			
	#	1	∅ 30
	441550		

X525011			
	#	1	∅ 32
	441948		

X525012			
	#	1	∅ 32
	441948		

X525013			
	#	1	∅ 30
	441550		

X525014			
	#	1	∅ 30
	441550		

X525015			
	#	1	∅ 32
	441948		

X525016			
	#	1	∅ 32
	441948		

X525017			
	#	1	∅ 30
	441550		

X525018			
	#	1	∅ 30
	441550		

X525019			
	#	1	∅ 30
	441550		

X525020			
	#	1	∅ 30
	441550		

X525021			
	#	1	∅ 35

X525022			
	#	1	∅ 35

X554001			
	#	1	∅ 54

X554002			
	#	1	∅ 54



X554005			
	# 2	∅	54

X554006			
	# 2	∅	54

X554009			
	# 1	∅	57
	441700		

X554010			
	# 1	∅	57
	441700		

X554011			
	# 1	∅	48
	441536		

X554012			
	# 1	∅	48
	441536		

X554013			
	# 1	∅	48
	441673		

X554014			
	# 1	∅	48
	441673		

X554015			
	# 2	∅	42
	441890		

X554016			
	# 2	∅	42
	441890		

X554023			
	# 1	∅	48
	441673		

X554024			
	# 1	∅	48
	441673		

X554025			
	# 1	∅	48

X554026			
	# 1	∅	48

X554027			
	# 2	∅	40
	442108		

X554028			
	# 2	∅	40
	442108		



X554029				
	#	2	∅	43

X554030				
	#	2	∅	43

X554031				
	#	1	∅	57
	441700			

X554032				
	#	1	∅	57
	441700			

X554033				
	#	1	∅	68
	441155			

X554034				
	#	1	∅	68
	441155			

X554035				
	#	2	∅	43
	441890			

X554036				
	#	2	∅	43
	441890			

X554039				
	#	1	∅	54
	441737			

X554040				
	#	1	∅	54
	441737			

X554041				
	#	1	∅	54
	441737			

X554042				
	#	1	∅	54
	441737			



X554043				
	#	1	∅	68
	441155			



X554044				
	#	1	∅	68
	441155			

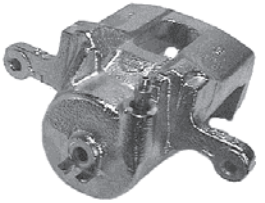

X554045				
	#	1	∅	68
	441155			

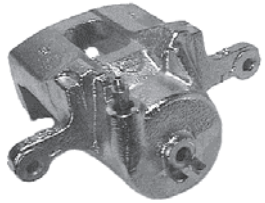

X554046				
	#	1	∅	68
	441155			









X554047			
	# 1	∅	60
			
	441168		



X554048			
	# 1	∅	60
			
	441168		



X554049			
	# 2	∅	48
			
	442058		



X554050			
	# 2	∅	48
			
	442058		



X554051			
	# 2	∅	46
			
	442131		



X554052			
	# 2	∅	46
			
	442131		



X554053			
	# 2	∅	46
			
	442131		



X554054			
	# 2	∅	46
			
	442131		



X554055			
	# 2	∅	45
			
	441482		



X554056			
	# 2	∅	45
			
	441482		

X554057			
	# 2	∅	45
			
	441482		



X554058			
	# 2	∅	45
			
	441482		



X554059			
	# 1	∅	57
			
	441662		

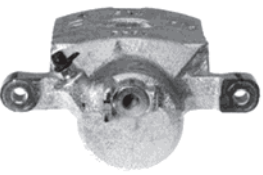

X554060			
	# 1	∅	57
			
	441662		

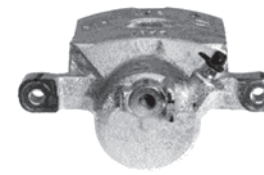

X554061			
	# 1	∅	57
			
	441700		

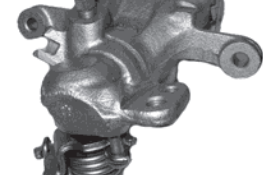

X554062			
	# 1	∅	57
			
	441700		

X554063				
	#	1	∅	51
				
	441672			



X554064				
	#	1	∅	51
				
	441672			



X555003				
	#	1	∅	34
				
	441636			

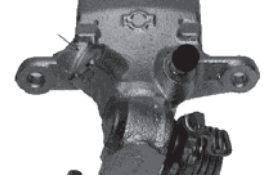

X555004				
	#	1	∅	34
				
	441636			



X555007				
	#	1	∅	38
				
	441856			



X555008				
	#	1	∅	38
				
	441856			



X555009				
	#	1	∅	30
				
	441771			



X555010				
	#	1	∅	30
				
	441771			



X555011				
	#	1	∅	34
				
	445329			

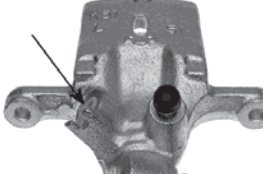

X555012				
	#	1	∅	34
				
	445329			



X555013				
	#	1	∅	34
				
	441636			

X555014				
	#	1	∅	34
				
	441636			

X555015				
	#	1	∅	34
				
	445329			

X555016				
	#	1	∅	34
				
	445329			

X555019				
	#	1	∅	48
				
	442059			

X555020				
	#	1	∅	48
				
	442059			



X555021				
	#	1	∅	38
	441856			

X555022				
	#	1	∅	38
	441856			

X555023				
	#	1	∅	38
	441223			

X555024				
	#	1	∅	38
	441223			

X584001				
	#	1	∅	51
	441894			

X584002				
	#	1	∅	51
	441894			

X584003				
	#	1	∅	54
	441982			

X584004				
	#	1	∅	54
	441982			

X584005				
	#	1	∅	57
	441742			

X584006				
	#	1	∅	57
	441742			

X584007				
	#	1	∅	51

X584008				
	#	1	∅	51

X584009				
	#	1	∅	57
	441638			



X584010				
	#	1	∅	57
	441638			

X584011				
	#	1	∅	51
	441894			

X584012				
	#	1	∅	51
	441894			









X584013				
	#	1	∅	51
				
				



X584014				
	#	1	∅	51
				
				

X584019				
	#	1	∅	48
				
				



X584020				
	#	1	∅	48
				
				



X584021				
	#	1	∅	51
				
	441894			



X584022				
	#	1	∅	51
				
	441894			



X584023				
	#	1	∅	51
				
	441850			



X584024				
	#	1	∅	51
				
	441850			



X584025				
	#	1	∅	54
				
	441903			



X584026				
	#	1	∅	54
				
	441903			



X584027				
	#	2	∅	38/42
				
	441898			

X584028				
	#	2	∅	38/42
				
	441898			

X584029				
	#	1	∅	57
				
	441638			

X584030				
	#	1	∅	57
				
	441638			

X584033				
	#	1	∅	57
				
	441638			

X584034				
	#	1	∅	57
				
	441638			



X584035				
	#	1	∅	51
	441719			

X584036				
	#	1	∅	51
	441719			

X584037				
	#	1	∅	57
	441638			

X584038				
	#	1	∅	57
	441638			

X584039				
	#	1	∅	54
	441903			

X584040				
	#	1	∅	54
	441903			

X584041				
	#	1	∅	51
	441850			

X584042				
	#	1	∅	51
	441850			

X584043				
	#	1	∅	54
	442132			

X584044				
	#	1	∅	54
	442132			

X584045				
	#	2	∅	38/42
	441898			

X584046				
	#	2	∅	38/42
	441898			



X584047				
	#	1	∅	54
	441903			



X584048				
	#	1	∅	54
	441903			



X584051				
	#	1	∅	57
	441638			



X584052				
	#	1	∅	57
	441638			







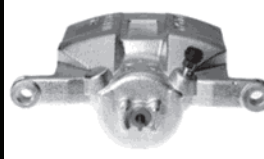

X584053			
	#	1	∅ 54
			
			



X584054			
	#	1	∅ 54
			
			



X584057			
	#	1	∅ 54
			
			



X584058			
	#	1	∅ 54
			
			



X584059			
	#	1	∅ 54
			
			



X584060			
	#	1	∅ 54
			
			

X584061			
	#	1	∅ 54
			
			



X584062			
	#	1	∅ 54
			
			



X585001			
	#	1	∅ 30
			
	441893		



X585002			
	#	1	∅ 30
			
	441893		



X585003			
	#	1	∅ 30
			
	441893		

X585004			
	#	1	∅ 30
			
	441893		



X585009			
	#	1	∅ 30
			
			

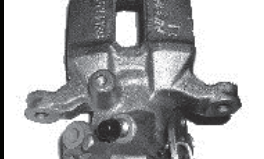

X585010			
	#	1	∅ 30
			
			



X585011			
	#	1	∅ 34
			
	442209		



X585012			
	#	1	∅ 34
			
	442209		







X585015			
	#	1	∅ 38
			
	441895		

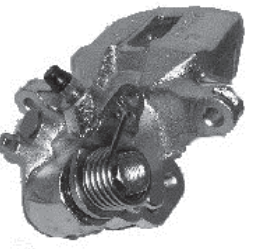

X585016			
	#	1	∅ 38
			
	441895		

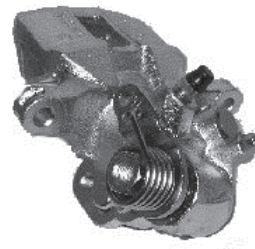

X585017			
	#	1	∅ 38
			
	442182		



X585018			
	#	1	∅ 38
			
	442182		

X585019			
	#	1	∅ 30
			
	441893		

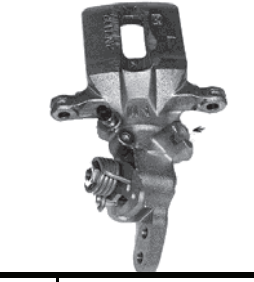
X585020			
	#	1	∅ 30
			
	441893		

X585021			
	#	1	∅ 34
			
	442209		



X585022			
	#	1	∅ 34
			
	442209		



X585023			
	#	1	∅ 34
			
	442209		

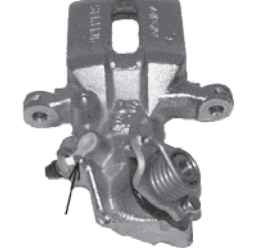

X585024			
	#	1	∅ 34
			
	442209		

X585025			
	#	1	∅ 38
			
	442182		

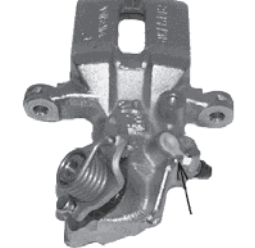
X585026			
	#	1	∅ 38
			
	442182		

X585027			
	#	1	∅ 34
			
	442209		

X585028			
	#	1	∅ 34
			
	442209		

X585031			
	#	1	∅ 34
			
	442209		

X585032			
	#	1	∅ 34
			
	442209		



X585033				
	#	1	∅	34
	442209			

X585034				
	#	1	∅	34
	442209			

X585035				
	#	1	∅	34
	442209			

X585036				
	#	1	∅	34
	442209			

X585037				
	#	1	∅	40

X585038				
	#	1	∅	40

X585039				
	#	1	∅	38
	441895			

X585040				
	#	1	∅	38
	441895			

X585041				
	#	1	∅	38
	442182			

X585042				
	#	1	∅	38
	442182			

X585043				
	#	1	∅	34
	442209			

X585044				
	#	1	∅	34
	442209			



X585045				
	#	1	∅	30
	441893			



X585046				
	#	1	∅	30
	441893			



X585047				
	#	1	∅	38
	441895			



X585048				
	#	1	∅	38
	441895			









X585049			
	# 1	∅ 38	
			
	441527		

X585050			
	# 1	∅ 38	
			
	441527		

X585051			
	# 1	∅ 38	
			
			



X585052			
	# 1	∅ 38	
			
			



X585053			
	# 1	∅ 40	
			
	441679		

X585054			
	# 1	∅ 40	
			
	441679		



X594001			
	# 1	∅ 60	
			
			

X594002			
	# 1	∅ 60	
			
			

X594003			
	# 1	∅ 60,32	
			
	442325		

X594004			
	# 1	∅ 60,32	
			
	442325		



X594011			
	# 2	∅ 42	
			
	442351		

X594012			
	# 2	∅ 42	
			
	442351		

X595001			
	# 1	∅ 40	
			
			

X595002			
	# 1	∅ 40	
			
			

X604001			
	# 4	∅ 34	
			
	441860		

X604002			
	# 4	∅ 34	
			
	441860		



X614001				
	#	4	∅	44
	441680			

X614002				
	#	4	∅	44
	441680			

X614003				
	#	4	∅	44
	441680			

X614004				
	#	4	∅	44
	441680			

X614005				
	#	4	∅	44
	441680			

X614006				
	#	4	∅	44
	441680			

X614009				
	#	2	∅	44
	441712			

X614010				
	#	2	∅	44
	441712			

X614011				
	#	4	∅	44
	441680			

X614012				
	#	4	∅	44
	441680			

X614013				
	#	4	∅	44
	441680			

X614014				
	#	4	∅	44
	441680			



X614019				
	#	4	∅	50



X614020				
	#	4	∅	50

X615001				
	#	2	∅	44
	441888			

X615002				
	#	2	∅	44
	441888			









X634001			
	#	1	∅ 57
			
	442082		

X634002			
	#	1	∅ 57
			
	442082		

X634003			
	#	1	∅ 57
			
	442082		



X634004			
	#	1	∅ 57
			
	442082		



X634005			
	#	1	∅ 57
			
	442082		

X634006			
	#	1	∅ 57
			
	442082		

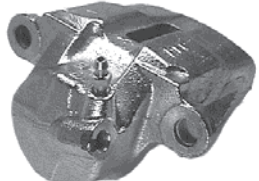

X634007			
	#	1	∅ 57
			
	442082		

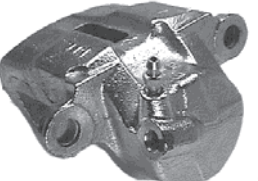
X634008			
	#	1	∅ 57
			
	442082		

X644001			
	#	1	∅ 54
			
			



X644002			
	#	1	∅ 54
			
			



X644003			
	#	1	∅ 51
			
	441907		

X644004			
	#	1	∅ 51
			
	441907		

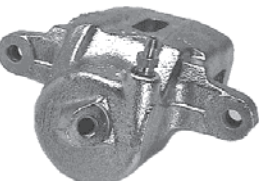

X644007			
	#	1	∅ 54
			
	441231		



X644008			
	#	1	∅ 54
			
	441231		

X644009			
	#	1	∅ 51
			
			

X644010			
	#	1	∅ 51
			
			









X644011			
	# 1	∅	51
			
	441897		



X644012			
	# 1	∅	51
			
	441897		



X644015			
	# 2	∅	54
			
	441696		



X644016			
	# 2	∅	54
			
	441696		



X644017			
	# 1	∅	60
			
			

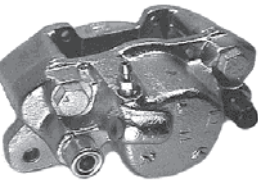

X644018			
	# 1	∅	60
			
			

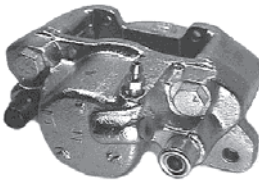

X644019			
	# 1	∅	57
			
	441704		



X644020			
	# 1	∅	57
			
	441704		



X644021			
	# 1	∅	48
			
	441598		



X644022			
	# 1	∅	48
			
	441598		

X644023			
	# 2	∅	48
			
	441131		

X644024			
	# 2	∅	48
			
	441131		



X644025			
	# 1	∅	54
			
	441231		



X644026			
	# 1	∅	54
			
	441231		

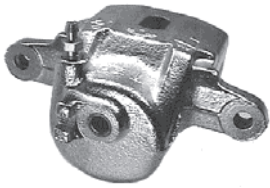

X644029			
	# 1	∅	51
			
			



X644030			
	# 1	∅	51
			
			



X644031				
	#	1	∅	51
				
				



X644032				
	#	1	∅	51
				
				



X644033				
	#	1	∅	51
				
	441772			



X644034				
	#	1	∅	51
				
	441772			



X644035				
	#	1	∅	51
				
				

X644036				
	#	1	∅	51
				
				

X644037				
	#	1	∅	51
				
				

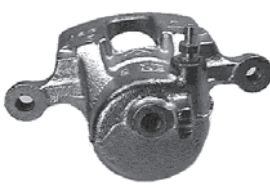

X644038				
	#	1	∅	51
				
				



X644041				
	#	1	∅	51
				
				



X644042				
	#	1	∅	51
				
				

X644045				
	#	1	∅	60
				
				

X644046				
	#	1	∅	60
				
				

X644047				
	#	1	∅	60
				
	441884			

X644048				
	#	1	∅	60
				
	441884			

X644051				
	#	1	∅	57
				
				

X644052				
	#	1	∅	57
				
				



X644053			
	# 4	∅ 34/43	
			
	441851		



X644054			
	# 4	∅ 34/43	
			
	441851		



X644055			
	# 4	∅ 43	
			
	441190		

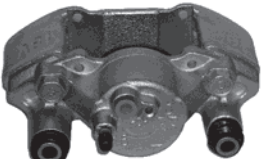

X644056			
	# 4	∅ 43	
			
	441190		

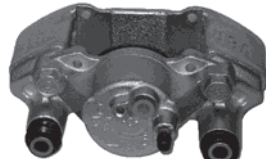

X644057			
	# 4	∅ 34/43	
			
	441851		

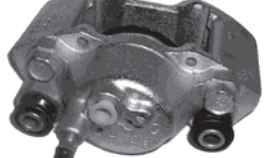

X644058			
	# 4	∅ 34/43	
			
	441851		

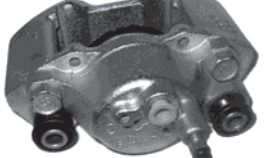

X644059			
	# 1	∅ 54	
			
	441538		

X644060			
	# 1	∅ 54	
			
	441538		

X644065			
	# 1	∅ 48	
			
	441828		



X644066			
	# 1	∅ 48	
			
	441828		



X644067			
	# 1	∅ 51	
			
	441879		

X644068			
	# 1	∅ 51	
			
	441879		



X644069			
	# 4	∅ 36	
			
	442085		



X644070			
	# 4	∅ 36	
			
	442085		



X644071			
	# 1	∅ 54	
			
	441538		



X644072			
	# 1	∅ 54	
			
	441538		







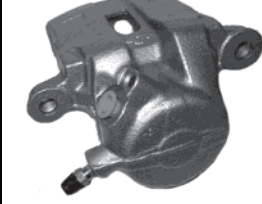

X644073			
	# 1	∅	57
			
			



X644074			
	# 1	∅	57
			
			



X644075			
	# 1	∅	51
			
	442012		



X644076			
	# 1	∅	51
			
	442012		



X644077			
	# 2	∅	48
			
			

X644078			
	# 2	∅	48
			
			



X644081			
	# 2	∅	54
			
	441696		



X644082			
	# 2	∅	54
			
	441696		

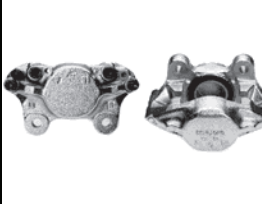

X644083			
	# 2	∅	54
			
			

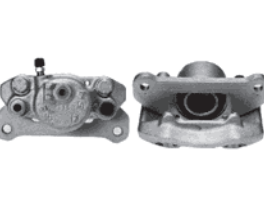

X644084			
	# 2	∅	54
			
			

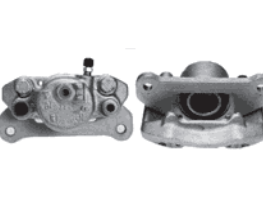

X644085			
	# 2	∅	54
			
	441696		

X644086			
	# 2	∅	54
			
	441696		

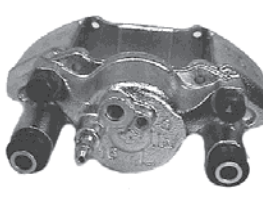
X644087			
	# 1	∅	51
			
			

X644088			
	# 1	∅	51
			
			

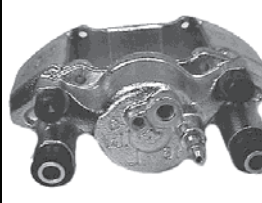
X644091			
	# 1	∅	54
			
	441961		

X644092			
	# 1	∅	54
			
	441961		



X644093				
	#	1	∅	54

X644094				
	#	1	∅	54

X644095				
	#	1	∅	60

X644096				
	#	1	∅	60

X644097				
	#	1	∅	57

X644098				
	#	1	∅	57

X644099				
	#	1	∅	54
	441852			

X644100				
	#	1	∅	54
	441852			

X644101				
	#	4	∅	40/43

X644102				
	#	4	∅	40/43

X644103				
	#	1	∅	51
	441854			

X644104				
	#	1	∅	51
	441854			



X644105				
	#	1	∅	51
	441854			

X644106				
	#	1	∅	51
	441854			



X644107				
	#	1	∅	54
	441852			



X644108				
	#	1	∅	54
	441852			







X644109				
	#	4	∅	40
				
	441855			



X644110				
	#	4	∅	40
				
	441855			



X644113				
	#	4	∅	40
				
	441855			

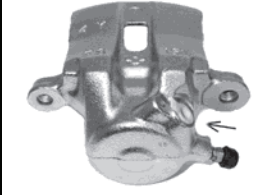

X644114				
	#	4	∅	40
				
	441855			

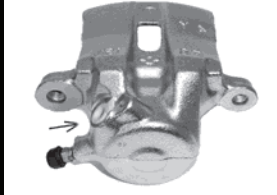

X644115				
	#	1	∅	54
				
	441942			



X644116				
	#	1	∅	54
				
	441942			

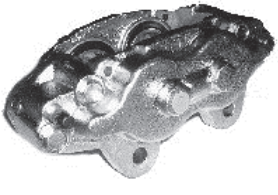

X644117				
	#	1	∅	51
				
	442012			



X644118				
	#	1	∅	51
				
	442012			

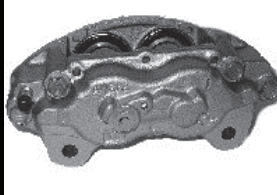

X644123				
	#	4	∅	45
				
	442117			



X644124				
	#	4	∅	45
				
	442117			



X644125				
	#	4	∅	45
				
	442117			

X644126				
	#	4	∅	45
				
	442117			

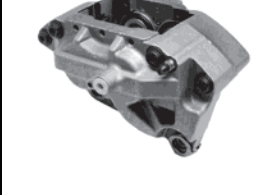
X644127				
	#	4	∅	45
				
	442117			

X644128				
	#	4	∅	45
				
	442117			

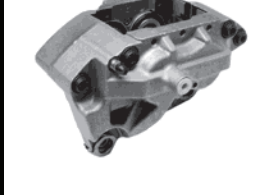
X644129				
	#	4	∅	43
				
	441190			

X644130				
	#	4	∅	43
				
	441190			



X644135				
	#	1	∅	57
	441880			

X644136				
	#	1	∅	57
	441880			

X644137				
	#	1	∅	57

X644138				
	#	1	∅	57

X644139				
	#	1	∅	68

X644140				
	#	1	∅	68

X644141				
	#	1	∅	57
	442009			

X644142				
	#	1	∅	57
	442009			

X644143				
	#	1	∅	60
	442193			

X644144				
	#	1	∅	60
	442193			

X644149				
	#	1	∅	57
	442197			

X644150				
	#	1	∅	57
	442197			



X644151				
	#	2	∅	45
	442118			



X644152				
	#	2	∅	45
	442118			



X644153				
	#	4	∅	45/51
	442119			

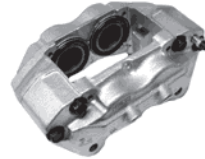

X644154				
	#	4	∅	45/51
	442119			



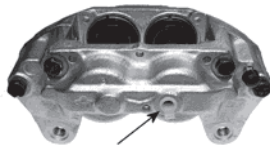

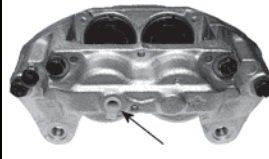

X644155				
	#	4	∅	45
				
	442117			

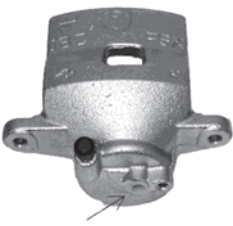

X644156				
	#	4	∅	45
				
	442117			

X644157				
	#	4	∅	40
				
	441855			

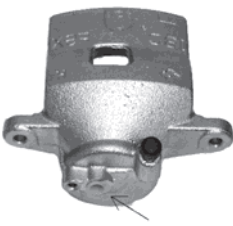

X644158				
	#	4	∅	40
				
	441855			



X644159				
	#	1	∅	54
				
	442076			



X644160				
	#	1	∅	54
				
	442076			



X644161				
	#	1	∅	54
				
	442352			



X644162				
	#	1	∅	54
				
	442352			



X644163				
	#	4	∅	45
				
	442455			



X644164				
	#	4	∅	45
				
	442455			



X644177				
	#	2	∅	45
				
	442118			

X644178				
	#	2	∅	45
				
	442118			

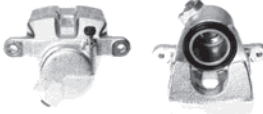

X644183				
	#	1	∅	54
				
	442076			



X644184				
	#	1	∅	54
				
	442076			



X644185				
	#	1	∅	54
				
	442076			

X644186				
	#	1	∅	54
				
	442076			





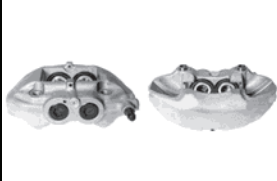



X644187			
	# 1	∅	57
			
	441557		



X644188			
	# 1	∅	57
			
	441557		



X644189			
	# 4	∅	43
			
	442256		

X644190			
	# 4	∅	43
			
	442256		

X644197			
	# 4	∅	43
			
	441190		



X644198			
	# 4	∅	43
			
	441190		



X644199			
	# 1	∅	48
			
	441518		

X644200			
	# 1	∅	48
			
	441518		



X644205			
	# 4	∅	51
			
	441558		



X644206			
	# 4	∅	51
			
	441558		

X644207			
	# 2	∅	43
			
	441481		

X644208			
	# 2	∅	43
			
	441481		



X644209			
	# 1	∅	54
			
	442189		



X644210			
	# 1	∅	54
			
	442189		

X644213			
	# 1	∅	60
			
	441699		

X644214			
	# 1	∅	60
			
	441699		









X644217				
	#	4	∅	45
				
	442117			



X644218				
	#	4	∅	45
				
	442117			

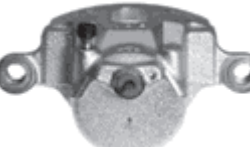

X644219				
	#	4	∅	48
				
	441657			



X644220				
	#	4	∅	48
				
	441657			



X644221				
	#	1	∅	60
				
	441884			



X644222				
	#	1	∅	60
				
	441884			



X644223				
	#	1	∅	60
				
	441884			



X644224				
	#	1	∅	60
				
	441884			



X644227				
	#	2	∅	43
				
				



X644228				
	#	2	∅	43
				
				



X645001				
	#	2	∅	43
				
	442198			

X645002				
	#	2	∅	43
				
	442198			



X645005				
	#	2	∅	38
				
	441587			

X645006				
	#	2	∅	38
				
	441587			



X645007				
	#	1	∅	40
				
	441242			



X645008				
	#	1	∅	40
				
	441242			



X645009				
	#	1	∅	48
				
	441868			



X645010				
	#	1	∅	48
				
	441868			



X645011				
	#	2	∅	38
				
	441587			



X645012				
	#	2	∅	38
				
	441587			



X645013				
	#	1	∅	43
				
				



X645014				
	#	1	∅	43
				
				

X645015				
	#	1	∅	48
				
	442202			



X645016				
	#	1	∅	48
				
	442202			



X645017				
	#	1	∅	32
				
	441950			



X645018				
	#	1	∅	32
				
	441950			



X645019				
	#	1	∅	43
				
	442247			

X645020				
	#	1	∅	43
				
	442247			



X645023				
	#	1	∅	30
				
	441951			



X645024				
	#	1	∅	30
				
	441951			

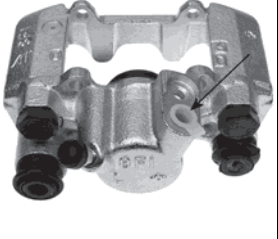

X645025				
	#	1	∅	32
				
	441950			

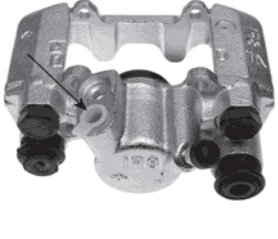

X645026				
	#	1	∅	32
				
	441950			









X645027			
	# 1	∅	34
			
	442261		

X645028			
	# 1	∅	34
			
	442261		

X645029			
	# 1	∅	36
			
	442359		



X645030			
	# 1	∅	36
			
	442359		



X645031			
	# 1	∅	48
			
	441868		



X645032			
	# 1	∅	48
			
	441868		

X645033			
	# 1	∅	48
			
	442202		



X645034			
	# 1	∅	48
			
	442202		



X645035			
	# 1	∅	30
			
	441951		



X645036			
	# 1	∅	30
			
	441951		



X645037			
	# 2	∅	43
			
	442259		

X645038			
	# 2	∅	43
			
	442259		



X645047			
	# 1	∅	45
			
	441555		



X645048			
	# 1	∅	45
			
	441555		



X645051			
	# 1	∅	48
			
	441868		



X645052			
	# 1	∅	48
			
	441868		







X674001			
	# 1	∅	51
			
	441959		

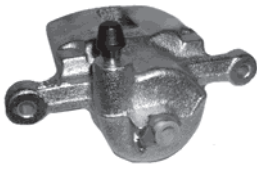

X674002			
	# 1	∅	51
			
	441959		

X674003			
	# 1	∅	48
			
	441777		

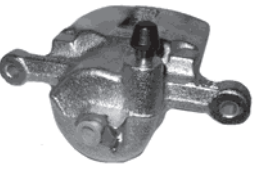
X674004			
	# 1	∅	48
			
	441777		



X674005			
	# 1	∅	48
			
	441536		



X674006			
	# 1	∅	48
			
	441536		

X674007			
	# 2	∅	48
			
			



X674008			
	# 2	∅	48
			
			



X674009			
	# 2	∅	48
			
			

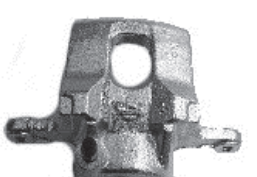

X674010			
	# 2	∅	48
			
			

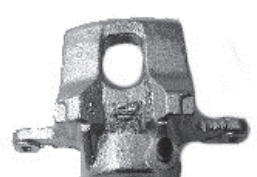

X674011			
	# 1	∅	48
			
	441536		

X674012			
	# 1	∅	48
			
	441536		

X674013			
	# 1	∅	60
			
	441168		

X674014			
	# 1	∅	60
			
	441168		

X674015			
	# 1	∅	45
			
	441582		

X674016			
	# 1	∅	45
			
	441582		



X674017				
	#	2	∅	51

X674018				
	#	2	∅	51

X674019				
	#	1	∅	51
	441959			

X674020				
	#	1	∅	51
	441959			

X674021				
	#	2	∅	48

X674022				
	#	2	∅	48

X674023				
	#	2	∅	48

X674024				
	#	2	∅	48

X674025				
	#	2	∅	48

X674026				
	#	2	∅	48

X674037				
	#	1	∅	51
	441959			

X674038				
	#	1	∅	51
	441959			



X674047				
	#	1	∅	51



X674048				
	#	1	∅	51

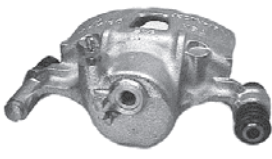

X674049				
	#	1	∅	57

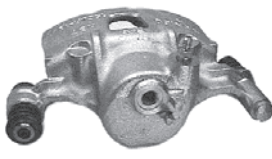

X674050				
	#	1	∅	57



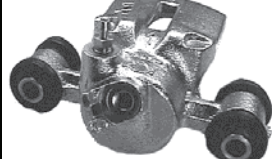





X674053				
	#	1	∅	51
				
	441740			



X674054				
	#	1	∅	51
				
	441740			

X674057				
	#	1	∅	45
				
	441582			



X674058				
	#	1	∅	45
				
	441582			



X674059				
	#	1	∅	51
				
	441781			

X674060				
	#	1	∅	51
				
	441781			

X674061				
	#	1	∅	48
				
	441923			



X674062				
	#	1	∅	48
				
	441923			

X674063				
	#	1	∅	57
				
	441862			



X674064				
	#	1	∅	57
				
	441862			



X674065				
	#	1	∅	48
				
				

X674066				
	#	1	∅	48
				
				



X674067				
	#	1	∅	54
				
	441737			



X674068				
	#	1	∅	54
				
	441737			

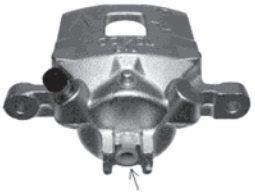

X674069				
	#	1	∅	48
				
	441536			

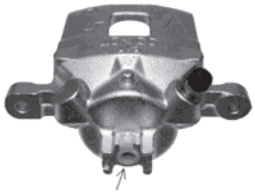

X674070				
	#	1	∅	48
				
	441536			









X674071				
	#	1	∅	51
				
	441781			



X674072				
	#	1	∅	51
				
	441781			



X674075				
	#	1	∅	54
				
	442098			



X674076				
	#	1	∅	54
				
	442098			



X674077				
	#	2	∅	43
				
	442212			



X674078				
	#	2	∅	43
				
	442212			



X674079				
	#	2	∅	43
				
	441890			



X674080				
	#	2	∅	43
				
	441890			



X674081				
	#	2	∅	43
				
	442212			



X674082				
	#	2	∅	43
				
	442212			



X674083				
	#	1	∅	60
				
	441631			

X674084				
	#	1	∅	60
				
	441631			

X674087				
	#	2	∅	43
				
	441625			

X674088				
	#	2	∅	43
				
	441625			

X674089				
	#	1	∅	60
				
	441634			

X674090				
	#	1	∅	60
				
	441634			



X674091			
	# 2	∅	43
	442212		

X674092			
	# 2	∅	43
	442212		

X674095			
	# 1	∅	57
	441700		

X674096			
	# 1	∅	57
	441700		

X675001			
	# 1	∅	30
	441978		

X675002			
	# 1	∅	30
	441978		

X675003			
	# 1	∅	43

X675004			
	# 1	∅	43

X675007			
	# 1	∅	38

X675008			
	# 1	∅	38

X675009			
	# 1	∅	34

X675010			
	# 1	∅	34



X675017			
	# 1	∅	30



X675018			
	# 1	∅	30

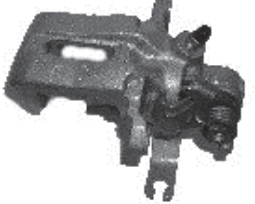

X675019			
	# 1	∅	38

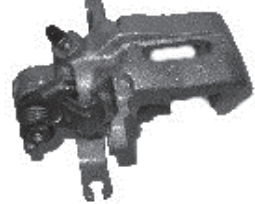

X675020			
	# 1	∅	38



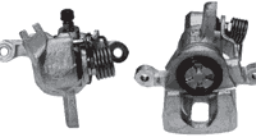

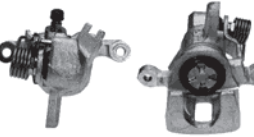

X675023				
	#	1	∅	43
				
				

X675024				
	#	1	∅	43
				
				

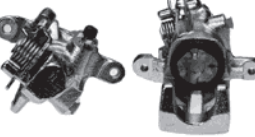
X675025				
	#	1	∅	34
				
				

X675026				
	#	1	∅	34
				
				

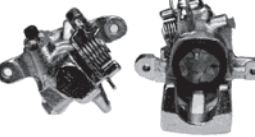
X675027				
	#	1	∅	43
				
	442113			



X675028				
	#	1	∅	43
				
	442113			



X675029				
	#	1	∅	30
				
	441531			



X675030				
	#	1	∅	30
				
	441531			



X675031				
	#	1	∅	38
				
				

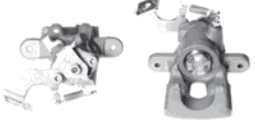

X675032				
	#	1	∅	38
				
				

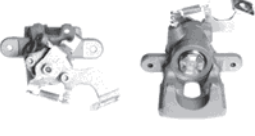

X675037				
	#	1	∅	34
				
	441636			

X675038				
	#	1	∅	34
				
	441636			



X675039				
	#	1	∅	34
				
				



X675040				
	#	1	∅	34
				
				



X675043				
	#	1	∅	43
				
	442113			

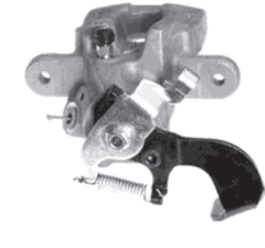

X675044				
	#	1	∅	43
				
	442113			



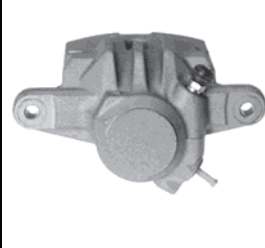

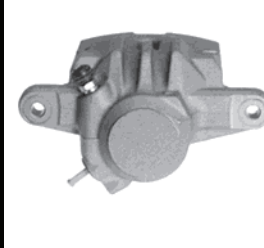

X675045			
	# 1	∅ 38	
			
	441548		

X675046			
	# 1	∅ 38	
			
	441548		

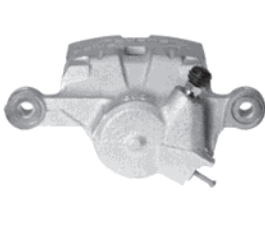
X675047			
	# 1	∅ 38	
			
			

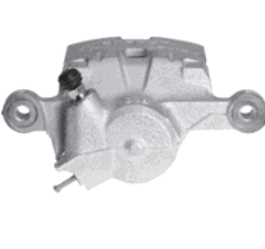

X675048			
	# 1	∅ 38	
			
			



X675049			
	# 1	∅ 38	
			
			



X675050			
	# 1	∅ 38	
			
			



X704001			
	# 1	∅ 51	
			
	441604		



X704002			
	# 1	∅ 51	
			
	441604		

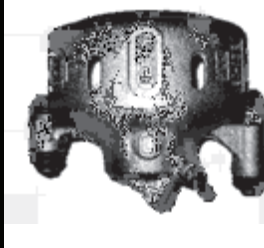

X704005			
	# 1	∅ 48	
			
	441768		



X704006			
	# 1	∅ 48	
			
	441768		

X704007			
	# 1	∅ 51	
			
	441604		

X704008			
	# 1	∅ 51	
			
	441604		

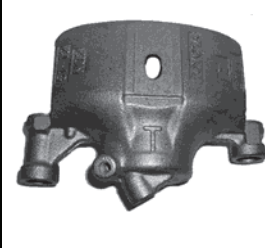

X704009			
	# 1	∅ 48	
			
	441768		



X704010			
	# 1	∅ 48	
			
	441768		

X704011			
	# 1	∅ 51	
			
	441604		

X704012			
	# 1	∅ 51	
			
	441604		









X704013				
	#	1	∅	54
				
	441844			



X704014				
	#	1	∅	54
				
	441844			

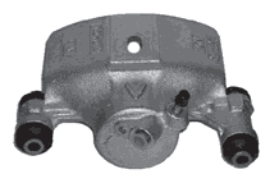

X704015				
	#	1	∅	57
				
	441866			



X704016				
	#	1	∅	57
				
	441866			



X704021				
	#	1	∅	51
				
	441604			



X704022				
	#	1	∅	51
				
	441604			



X704023				
	#	1	∅	51
				
	441604			



X704024				
	#	1	∅	51
				
	441604			



X704025				
	#	1	∅	54
				
	441942			

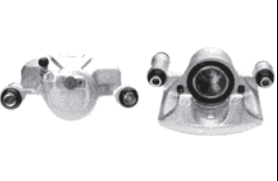

X704026				
	#	1	∅	54
				
	441942			



X704029				
	#	1	∅	51
				
	441604			

X704030				
	#	1	∅	51
				
	441604			

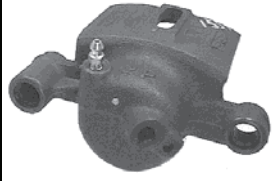

X704031				
	#	1	∅	57
				
	441866			



X704032				
	#	1	∅	57
				
	441866			



X704033				
	#	1	∅	48
				
	442121			



X704034				
	#	1	∅	48
				
	442121			









X704035				
	#	1	∅	51
				
	441604			



X704036				
	#	1	∅	51
				
	441604			



X704037				
	#	1	∅	48
				
	441597			

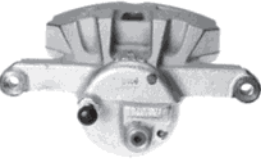

X704038				
	#	1	∅	48
				
	441597			



X704041				
	#	1	∅	48
				
				

X704042				
	#	1	∅	48
				
				

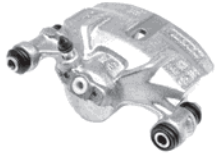

X704043				
	#	1	∅	63,5
				
	442398			

X704044				
	#	1	∅	63,5
				
	442398			



X705001				
	#	1	∅	43
				
	441970			

X705002				
	#	1	∅	43
				
	441970			



X705005				
	#	1	∅	43
				
	441969			

X705006				
	#	1	∅	43
				
	441969			



X734001				
	#	1	∅	48
				
	441791			



X734002				
	#	1	∅	48
				
	441791			



X734003				
	#	1	∅	48
				
	441792			



X734004				
	#	1	∅	48
				
	441792			







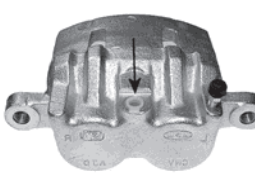

X734007			
	# 1	∅	48
			
	441791		



X734008			
	# 1	∅	48
			
	441791		



X774001			
	# 2	∅	46
			
	442192		



X774002			
	# 2	∅	46
			
	442192		



X774003			
	# 2	∅	46
			
	442043		



X774004			
	# 2	∅	46
			
	442043		



X774005			
	# 1	∅	54
			
	442225		

X774006			
	# 1	∅	54
			
	442225		



X774007			
	# 1	∅	66
			
	442242		



X774008			
	# 1	∅	66
			
	442242		



X774009			
	# 2	∅	46
			
	442192		

X774010			
	# 2	∅	46
			
	442192		



X774011			
	# 1	∅	51
			
	442167		



X774012			
	# 1	∅	51
			
	442167		



X774013			
	# 1	∅	60
			
	441884		



X774014			
	# 1	∅	60
			
	441884		









X774015				
	#	2	∅	46
				
	442192			

X774016				
	#	2	∅	46
				
	442192			

X774017				
	#	2	∅	51
				
	441565			



X774018				
	#	2	∅	51
				
	441565			



X774021				
	#	1	∅	54
				
	442187			



X774022				
	#	1	∅	54
				
	442187			



X774023				
	#	1	∅	57
				
	441570			



X774024				
	#	1	∅	57
				
	441570			



X774025				
	#	1	∅	60
				
	442460			

X774026				
	#	1	∅	60
				
	442460			

X774027				
	#	1	∅	57
				
	442250			

X774028				
	#	1	∅	57
				
	442250			



X774029				
	#	1	∅	60
				
	441682			



X774030				
	#	1	∅	60
				
	441682			



X774031				
	#	1	∅	54
				
	442187			



X774032				
	#	1	∅	54
				
	442187			









X774033			
	# 2	∅	46
			
			



X774034			
	# 2	∅	46
			
			



X774035			
	# 1	∅	60
			
	441682		



X774036			
	# 1	∅	60
			
	441682		



X774037			
	# 1	∅	60
			
	441682		



X774038			
	# 1	∅	60
			
	441682		



X774039			
	# 1	∅	57
			
	441570		



X774040			
	# 1	∅	57
			
	441570		



X774041			
	# 1	∅	57
			
	441570		

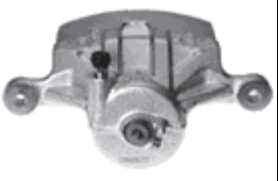

X774042			
	# 1	∅	57
			
	441570		



X774043			
	# 1	∅	60
			
	441682		

X774044			
	# 1	∅	60
			
	441682		



X774045			
	# 1	∅	57
			
	441570		



X774046			
	# 1	∅	57
			
	441570		



X774047			
	# 2	∅	46
			
	441569		

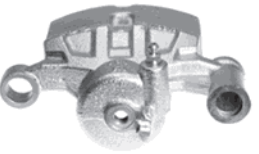

X774048			
	# 2	∅	46
			
	441569		



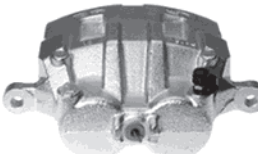





X774049			
	# 1	∅	51
			
	441692		



X774050			
	# 1	∅	51
			
	441692		



X774051			
	# 2	∅	48
			
	441686		

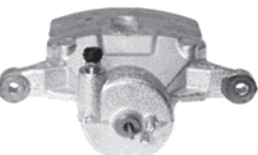

X774052			
	# 2	∅	48
			
	441686		



X774053			
	# 1	∅	57
			
	441570		



X774054			
	# 1	∅	57
			
	441570		

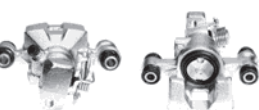

X774055			
	# 1	∅	57
			
	441570		

X774056			
	# 1	∅	57
			
	441570		

X775001			
	# 1	∅	38
			
	442249		



X775002			
	# 1	∅	38
			
	442249		

X775003			
	# 1	∅	43
			
	442042		

X775004			
	# 1	∅	43
			
	442042		

X775005			
	# 1	∅	34
			
	442172		

X775006			
	# 1	∅	34
			
	442172		



X775007			
	# 1	∅	30
			
	442226		



X775008			
	# 1	∅	30
			
	442226		









X775009			
	#	1	∅ 34
			
	442172		



X775010			
	#	1	∅ 34
			
	442172		



X775011			
	#	1	∅ 34
			
	441588		



X775012			
	#	1	∅ 34
			
	441588		



X775013			
	#	1	∅ 38
			
	441563		

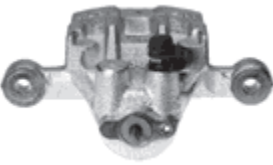

X775014			
	#	1	∅ 38
			
	441563		

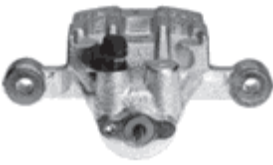

X775015			
	#	1	∅ 34
			
	441588		



X775016			
	#	1	∅ 34
			
	441588		



X775017			
	#	1	∅ 34
			
	441588		

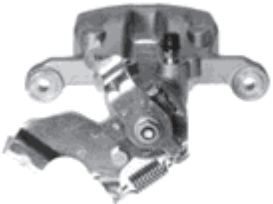

X775018			
	#	1	∅ 34
			
	441588		

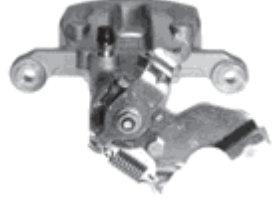

X775019			
	#	1	∅ 43
			
	441635		

X775020			
	#	1	∅ 43
			
	441635		

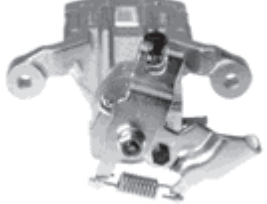
X775021			
	#	1	∅ 34
			
	441637		

X775022			
	#	1	∅ 34
			
	441637		

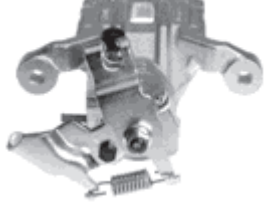
X775023			
	#	1	∅ 34
			
	441637		

X775024			
	#	1	∅ 34
			
	441637		



X775025				
	#	1	∅	43
	441549			

X775026				
	#	1	∅	43
	441549			

X775027				
	#	1	∅	34
	441588			

X775028				
	#	1	∅	34
	441588			

X775029				
	#	1	∅	34
	441702			

X775030				
	#	1	∅	34
	441702			

X775031				
	#	1	∅	34
	441702			

X775032				
	#	1	∅	34
	441702			

X775033				
	#	1	∅	42
	441623			

X775034				
	#	1	∅	42
	441623			

X777001E				
	#	1	∅	34

X777002E				
	#	1	∅	34



X794001				
	#	1	∅	57



X794002				
	#	1	∅	57



X794003				
	#	1	∅	-

X794004				
	#	1	∅	-









X794005				
	#	1	∅	-
				
				

X794006				
	#	1	∅	-
				
				



X794007				
	#	1	∅	60
				
				



X794008				
	#	1	∅	60
				
				



X794009				
	#	1	∅	66
				
				



X794010				
	#	1	∅	66
				
				



X794011				
	#	1	∅	60
				
				



X794012				
	#	1	∅	60
				
				



X794013				
	#	1	∅	80
				
				

X794014				
	#	1	∅	80
				
				

X794017				
	#	1	∅	63,5
				
				

X794018				
	#	1	∅	63,5
				
				



X794019				
	#	1	∅	78,6
				
				



X794020				
	#	1	∅	78,6
				
				



X794021				
	#	1	∅	63,5
				
				



X794022				
	#	1	∅	63,5
				
				



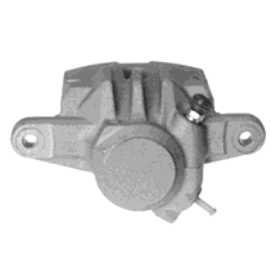

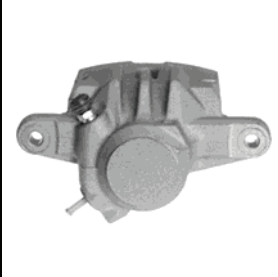

X675045			
	#	1	∅ 38
			
	441548		

X675046			
	#	1	∅ 38
			
	441548		

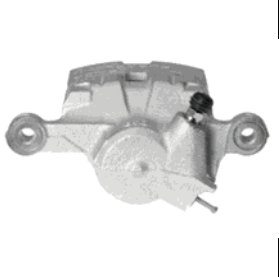
X675047			
	#	1	∅ 38
			
			

X675048			
	#	1	∅ 38
			
			

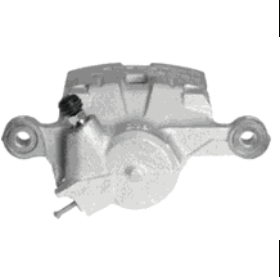
X675049			
	#	1	∅ 38
			
			



X675050			
	#	1	∅ 38
			
			

X704001			
	#	1	∅ 51
			
	441604		



X704002			
	#	1	∅ 51
			
	441604		



X704005			
	#	1	∅ 48
			
	441768		



X704006			
	#	1	∅ 48
			
	441768		

X704007			
	#	1	∅ 51
			
	441604		

X704008			
	#	1	∅ 51
			
	441604		



X704009			
	#	1	∅ 48
			
	441768		



X704010			
	#	1	∅ 48
			
	441768		

X704011			
	#	1	∅ 51
			
	441604		

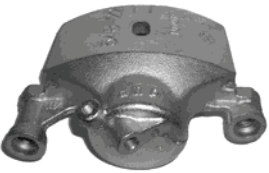
X704012			
	#	1	∅ 51
			
	441604		









X704013				
	#	1	∅	54
				
	441844			

X704014				
	#	1	∅	54
				
	441844			



X704015				
	#	1	∅	57
				
	441866			



X704016				
	#	1	∅	57
				
	441866			



X704021				
	#	1	∅	51
				
	441604			



X704022				
	#	1	∅	51
				
	441604			



X704023				
	#	1	∅	51
				
	441604			



X704024				
	#	1	∅	51
				
	441604			



X704025				
	#	1	∅	54
				
	441942			

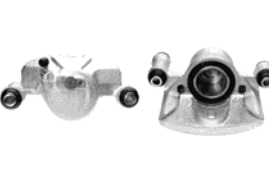

X704026				
	#	1	∅	54
				
	441942			



X704029				
	#	1	∅	51
				
	441604			

X704030				
	#	1	∅	51
				
	441604			

X704031				
	#	1	∅	57
				
	441866			

X704032				
	#	1	∅	57
				
	441866			



X704033				
	#	1	∅	48
				
	442121			



X704034				
	#	1	∅	48
				
	442121			









X704035				
	#	1	∅	51
				
	441604			



X704036				
	#	1	∅	51
				
	441604			



X704037				
	#	1	∅	48
				
	441597			



X704038				
	#	1	∅	48
				
	441597			



X704041				
	#	1	∅	48
				
				



X704042				
	#	1	∅	48
				
				



X704043				
	#	1	∅	63,5
				
	442398			



X704044				
	#	1	∅	63,5
				
	442398			



X705001				
	#	1	∅	43
				
	441970			



X705002				
	#	1	∅	43
				
	441970			



X705005				
	#	1	∅	43
				
	441969			

X705006				
	#	1	∅	43
				
	441969			

X734001				
	#	1	∅	48
				
	441791			

X734002				
	#	1	∅	48
				
	441791			

X734003				
	#	1	∅	48
				
	441792			

X734004				
	#	1	∅	48
				
	441792			



X734007				
	#	1	∅	48
	441791			

X734008				
	#	1	∅	48
	441791			

X774001				
	#	2	∅	46
	442192			

X774002				
	#	2	∅	46
	442192			

X774003				
	#	2	∅	46
	442043			

X774004				
	#	2	∅	46
	442043			

X774005				
	#	1	∅	54
	442225			

X774006				
	#	1	∅	54
	442225			

X774007				
	#	1	∅	66
	442242			

X774008				
	#	1	∅	66
	442242			

X774009				
	#	2	∅	46
	442192			

X774010				
	#	2	∅	46
	442192			



X774011				
	#	1	∅	51
	442167			



X774012				
	#	1	∅	51
	442167			



X774013				
	#	1	∅	60
	441884			



X774014				
	#	1	∅	60
	441884			









X774015				
	#	2	∅	46
				
	442192			

X774016				
	#	2	∅	46
				
	442192			



X774017				
	#	2	∅	51
				
	441565			



X774018				
	#	2	∅	51
				
	441565			



X774021				
	#	1	∅	54
				
	442187			



X774022				
	#	1	∅	54
				
	442187			



X774023				
	#	1	∅	57
				
	441570			



X774024				
	#	1	∅	57
				
	441570			



X774025				
	#	1	∅	60
				
	442460			



X774026				
	#	1	∅	60
				
	442460			



X774027				
	#	1	∅	57
				
	442250			

X774028				
	#	1	∅	57
				
	442250			



X774029				
	#	1	∅	60
				
	441682			



X774030				
	#	1	∅	60
				
	441682			



X774031				
	#	1	∅	54
				
	442187			



X774032				
	#	1	∅	54
				
	442187			









X774033				
	#	2	∅	46
				
				



X774034				
	#	2	∅	46
				
				



X774035				
	#	1	∅	60
				
	441682			



X774036				
	#	1	∅	60
				
	441682			



X774037				
	#	1	∅	60
				
	441682			



X774038				
	#	1	∅	60
				
	441682			



X774039				
	#	1	∅	57
				
	441570			



X774040				
	#	1	∅	57
				
	441570			



X774041				
	#	1	∅	57
				
	441570			



X774042				
	#	1	∅	57
				
	441570			



X774043				
	#	1	∅	60
				
	441682			

X774044				
	#	1	∅	60
				
	441682			

X774045				
	#	1	∅	57
				
	441570			

X774046				
	#	1	∅	57
				
	441570			

X774047				
	#	2	∅	46
				
	441569			

X774048				
	#	2	∅	46
				
	441569			



X774049				
	#	1	∅	51
		441692		

X774050				
	#	1	∅	51
		441692		

X774051				
	#	2	∅	48
		441686		

X774052				
	#	2	∅	48
		441686		

X774053				
	#	1	∅	57
		441570		

X774054				
	#	1	∅	57
		441570		

X774055				
	#	1	∅	57
		441570		

X774056				
	#	1	∅	57
		441570		

X775001				
	#	1	∅	38
		442249		

X775002				
	#	1	∅	38
		442249		

X775003				
	#	1	∅	43
		442042		

X775004				
	#	1	∅	43
		442042		



X775005				
	#	1	∅	34
		442172		



X775006				
	#	1	∅	34
		442172		



X775007				
	#	1	∅	30
		442226		



X775008				
	#	1	∅	30
		442226		









X775009			
	#	1	∅ 34
			
	442172		



X775010			
	#	1	∅ 34
			
	442172		



X775011			
	#	1	∅ 34
			
	441588		



X775012			
	#	1	∅ 34
			
	441588		



X775013			
	#	1	∅ 38
			
	441563		



X775014			
	#	1	∅ 38
			
	441563		



X775015			
	#	1	∅ 34
			
	441588		



X775016			
	#	1	∅ 34
			
	441588		



X775017			
	#	1	∅ 34
			
	441588		

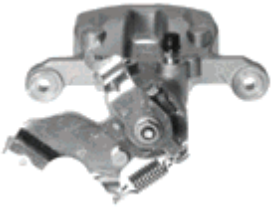

X775018			
	#	1	∅ 34
			
	441588		

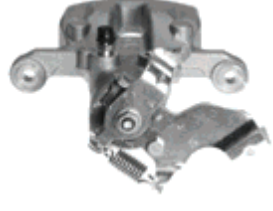

X775019			
	#	1	∅ 43
			
	441635		

X775020			
	#	1	∅ 43
			
	441635		



X775021			
	#	1	∅ 34
			
	441637		



X775022			
	#	1	∅ 34
			
	441637		



X775023			
	#	1	∅ 34
			
	441637		

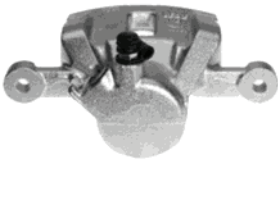

X775024			
	#	1	∅ 34
			
	441637		









X775025				
	#	1	∅	43
				
	441549			



X775026				
	#	1	∅	43
				
	441549			



X775027				
	#	1	∅	34
				
	441588			

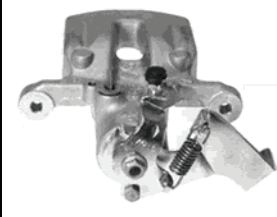

X775028				
	#	1	∅	34
				
	441588			

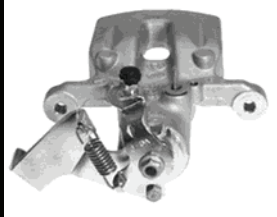

X775029				
	#	1	∅	34
				
	441702			



X775030				
	#	1	∅	34
				
	441702			



X775031				
	#	1	∅	34
				
	441702			



X775032				
	#	1	∅	34
				
	441702			



X775033				
	#	1	∅	42
				
	441623			



X775034				
	#	1	∅	42
				
	441623			

X777001E				
	#	1	∅	34
				
				

X777002E				
	#	1	∅	34
				
				



X794001				
	#	1	∅	57
				
				



X794002				
	#	1	∅	57
				
				

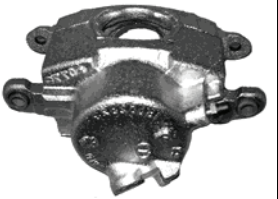

X794003				
	#	1	∅	-
				
				

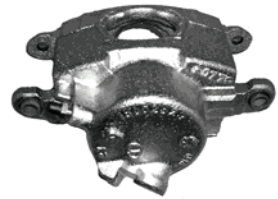

X794004				
	#	1	∅	-
				
				









X794005				
	#	1	∅	-
				
				



X794006				
	#	1	∅	-
				
				



X794007				
	#	1	∅	60
				
				



X794008				
	#	1	∅	60
				
				

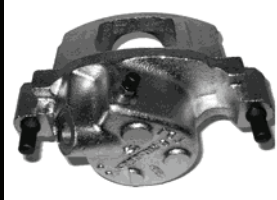

X794009				
	#	1	∅	66
				
				



X794010				
	#	1	∅	66
				
				



X794011				
	#	1	∅	60
				
				



X794012				
	#	1	∅	60
				
				



X794013				
	#	1	∅	80
				
				



X794014				
	#	1	∅	80
				
				



X794017				
	#	1	∅	63,5
				
				

X794018				
	#	1	∅	63,5
				
				

X794019				
	#	1	∅	78,6
				
				



X794020				
	#	1	∅	78,6
				
				

X794021				
	#	1	∅	63,5
				
				

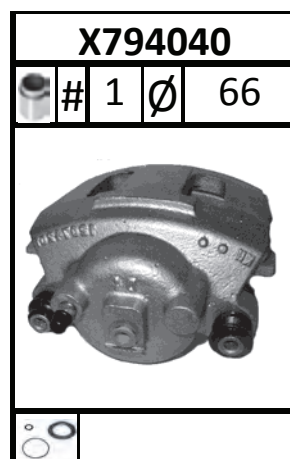
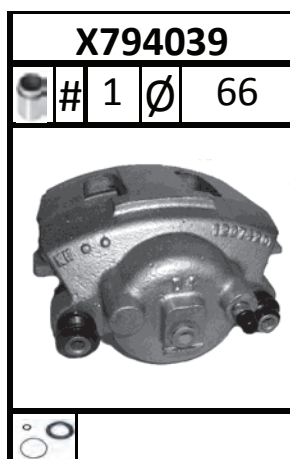
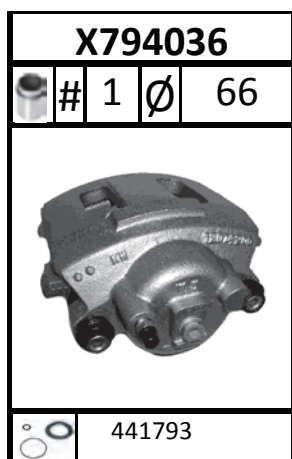
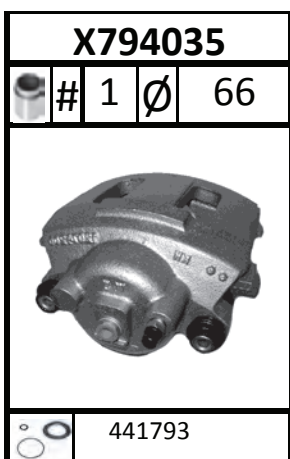
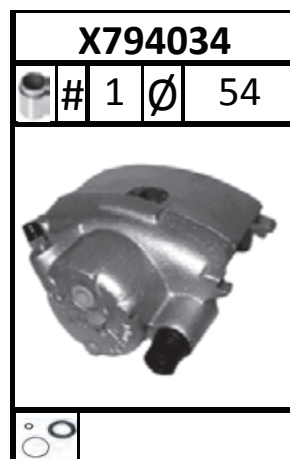
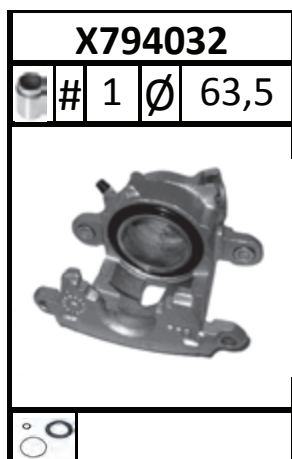
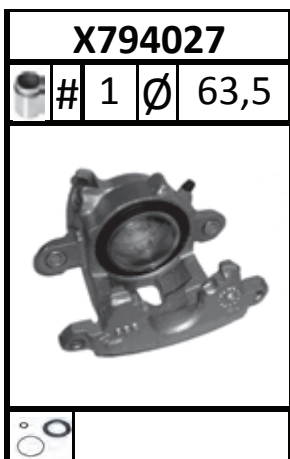
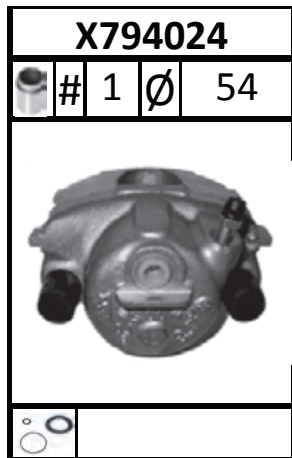
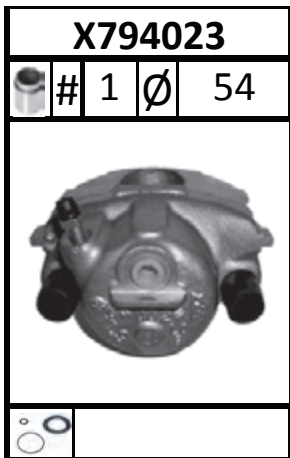

X794022				
	#	1	∅	63,5
				
				











X794049			
	# 1	∅	66
			
			



X794050			
	# 1	∅	66
			
			

X794085			
	# 1	∅	63,5
			
	441809		

X794086			
	# 1	∅	63,5
			
	441809		

X794125			
	# 2	∅	48
			
	442318		

X794126			
	# 2	∅	48
			
	442318		

X795001			
	# 1	∅	48
			
	442001		

X795002			
	# 1	∅	48
			
	442001		

X795003			
	# 1	∅	54
			
			



X795004			
	# 1	∅	54
			
			



X795005			
	# 1	∅	35
			
			

X795006			
	# 1	∅	35
			
			

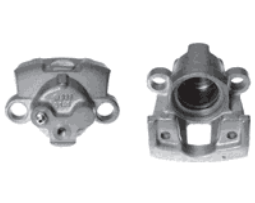
X795007			
	# 1	∅	45
			
			

X795008			
	# 1	∅	45
			
			

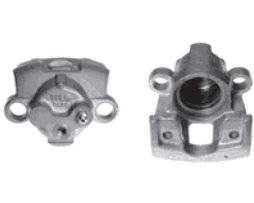
X795031			
	# 1	∅	48
			
	442001		

X795032			
	# 1	∅	48
			
	442001		



MOTIFS DE REFUS DE LA DECONSIGNE

REFUSAL REASONS OF OLD CORE
ABLEHNUNGSGRÜNDE DES ALTEILS
MOTIVOS DE RECHAZO DEL CASCO
MOTIVI DI RIFIUTO DELLA CARCASSA



ETR01



ETR02

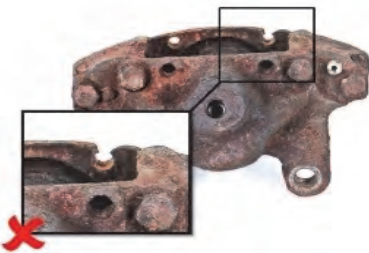

ETR03



ETR04



ETR05



MOTIFS DE REFUS DE LA DECONSIGNE

REFUSAL REASONS OF OLD CORE
ABLEHNUNGSGRÜNDE DES ALTHEILS
MOTIVOS DE RECHAZO DEL CASCO
MOTIVI DI RIFIUTO DELLA CARCASSA



ETR06



ETR07

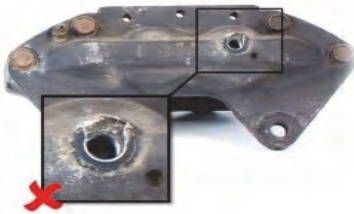

ETR08

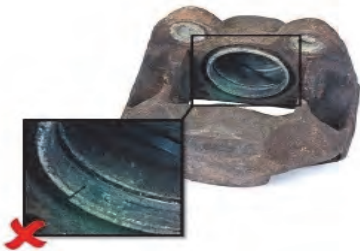

ETR09

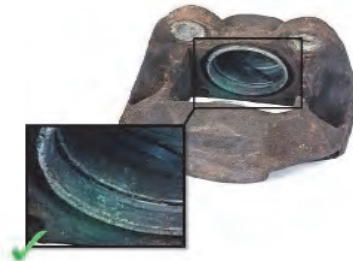

ETR10



MOTIFS DE REFUS DE LA DECONSIGNE

ABLEHNUNGSGRÜNDE DES ALTHEILS

REFUSAL REASONS OF OLD CORE

MOTIVOS DE RECHAZO DEL CASCO

MOTIVI DI RIFIUTO DELLA CARCASSA

	FR	EN	DE	SP	IT
ETR01	Manque patte	Missing tab	Lasche fehlt	Soporte que falta	Molla mancante
ETR02	Etrier cassé	Broken brake caliper	Bremssattel gebrochen	Pinza de freno rota	Pinza di freno rotta
ETR03	Trou de fixation endommagé	Damaged fixing hole	Befestigungsloch beschädigt	Agujero de fijación defectuoso	Foro di fissaggio difettoso
ETR04	Nez limé par le disque de frein	Nose rubbed by the brake disc	Nase wurde von der Bremsscheibe abgefeilt	Nariz limada por el disco de freno	Naso limato per il disco di freno
ETR05	Manque nez	Missing nose	Nase fehlt	Nariz que falta	Naso mancante
ETR06	Manque piston	Missing piston	Kolben fehlt	Pistón que falta	Pistone mancante
ETR07	Filetage intérieur endommagé	Damaged inner thread	Inneres Gewinde beschädigt	Estrías lado caja defectuosas	Scanalature lato ruota difettose
ETR08	Filetage cassé	Broken thread	Gewinde gebrochen	Estrías rotas	Scanalature rotte
ETR09	Etrier fissuré	Cracked brake caliper	Bremssattel rissig	Pinza de freno agrietada	Pinza di freno incrinata
ETR10	Etrier endommagé	Damaged brake caliper	Bremssattel beschädigt	Pinza de freno defectuosa	Pinza di freno difettosa

































FR	<p>Les pièces retournées avec l'un des défauts ci-dessus ne donneront pas lieu à une déconsigne. (La liste des pannes présentées dans ce document est non exhaustive). Sont expressément exclus tous retours pour déconsigne de pièces usagées qui seraient affectés notamment de brisures ou fissures dans les éléments moulés ou et/ou parties essentielles, dégâts causés par le feu, unité incomplète ou démontée, unité de fabrication non OEM.</p>
-----------	--

EN	<p>The parts returned with one of the damages listed above will not be accepted as old cores. (the list of the above mentioned damages is not exhaustive) All returned cores showing cracked or broken moulded elements and/or essential parts, damages caused by fire, incomplete or disassembled units, non-OE units, will be formally refused.</p>
-----------	---

DE	<p>Die zurückgeschickten Teile, die wegen den oben genannten Schäden nicht in Ordnung sein sollten, werden als Altteile nicht angenommen (diese Liste der Abhlehungsgründen ist nicht vollständig). Alle Altteile, die von folgenden Schäden betroffen sein sollten, werden ausdrücklich abgelehnt: gerissene oder gebrochene gespritzte Elemente und/oder wesentliche Teile, vom Feuer entstandenen Schäden, unvollständige oder auseinandergebaute Teile, nicht-OEM Teile.</p>
-----------	--

SP	<p>Las piezas devueltas con uno de los defectos mencionados más arriba no serán aceptadas como cascos. (La lista de las averías presentadas en este documento no es exhaustiva). Queda expresamente excluida cualquier devolución para abono del casco que tendría en particular partidos o grietas en los elementos moldeados y/o partes esenciales, daños causados por el fuego, pieza incompleta o desmontada, pieza de fabricación no OEM.</p>
-----------	--

IT	<p>I pezzi respinti per uno dei motivi sopra menzionati non saranno accettati come carcasse. (L'elenco dei guasti presentati in questo documento non é esauriente). Sono espressamente esclusi ogni reso per credito della carcassa che avrebbero in particolare incrinature o fessure nei elementi fusi e/o parti essenziali, danni da incendio, unità incompleta smontata, unità di fabbricazione non OEM.</p>
-----------	--

	FR	EN	DE	SP	IT
	A l'avant	In the front	Vorne	En la parte delantera	Nella parte anteriore
	A l'arrière	Behind	Hinten	En la parte trasera	Nel retro
	Devant la roue	In front of the wheel	Vor dem Rad	Delante de la rueda	Davanti alla ruota
	Derrière la roue	Behind the wheel	Hinter dem Rad	Tras el volante	Al volante
	Pour disque de frein ventilé	For ventilated brake disc	Gelüftete Bremsscheibe	Para disco de freno ventilado	Per disco di freno ventilato
	Pour disque de frein plein	For full brake disc	Für volle Bremsscheibe	Para disco de freno lleno	Per disco di freno pieno
	Frein à main avec levier	Lever hand brake	Handbremse mit Hebel	Freno de mano con palanca	Freno a mano con leva
	Frein à main avec bouton	Hand brake with button	Handbremse mit Knopf	Freno de mano con botón	Freno a mano con pulsante
	Avec ABS	With ABS	Mit ABS	Con ABS	Con ABS
	Sans ABS	Without ABS	Ohne ABS	Sin ABS	Senza ABS
	Avec ESP	With ESP	Mit ESP	Con ESP	Con ESP
	Sans ESP	Without ESP	Ohne ESP	Sin ESP	Sin ESP
	Diamètre de la jante	Rim diameter	Felgedurchmesser	Diámetro de la llanta	Diametro del cerchione
	Châssis	Chassis	Fahrgestell	Chasis	Telaio
	1 Flexible hydraulique	1 flexible pipe	1 hydraulischer Schlauch	1 tubo flexible hidráulico	1 tubo flessibile idraulico
	∅ Diamètre du câble de frein = X	Brake cable diameter = X	Bremskabeldurchmesser = X	Diámetro del cable de freno = X	Diametro del tubo di freno = X
	∅ Raccord du flexible hydraulique	∅ Hydraulic hose connection	∅ der Hydraulikschlauchkupplung	∅ conexión del flexible hidráulico	∅ dell'accoppiamento del tubo flessibile idraulico
	2 Flexibles hydrauliques	2 flexible pipes	2 hydraulische Schläuche	2 tubos flexibles hidráulicos	2 tubi flessibili idraulico
	Plaquette de frein symétrique	Symmetrical brake pad	Bremsbelag symmetrisch	Pastilla de freno simétrica	Pastiglia dei freni simmetrica
	Plaquette de frein décalée	Shifted brake pad	Bremsbelag versetzt	Pastilla de freno movida	Pastiglia dei freni spostata
	∅ Trous de fixation	∅ fixing holes	∅ Befestigungslöcher	∅ Agujeros de fijación	∅ Fori di fissaggio
	Poids max. autorisé	Max. authorized weight	Max. erlaubtes Gewicht	Peso max. autorizado	Peso mass. autorizzato
	Etrier non électrique	Non electrical caliper	Nicht elektrischer Bremssattel	Pinza de freno no eléctrica	Pinza di freno non elettrica
	Roues simples	Simple wheels	Einzigräder	Ruedas únicas	Ruote uniche
	Roues doubles	Double wheels	Doppelräder	Ruedas gemelas	Ruote gemellate
	En aluminium	Aluminium	Aluminium	De aluminio	Di alluminio
	En fonte	Cast iron	Guss	De fundición	Di ghisa
	Etrier avec ressort	Caliper with spring	Bremssattel mit Feder	Pinza de freno con pasador	Pinza di freno con molla
	Etrier sans ressort	Caliper without spring	Bremssattel ohne Feder	Pinza de freno sin pasador	Pinza di freno senza molla
	#ID: Numéro gravé sur l'étrier	Number carved on the caliper	Auf den Bremssattel eingegrützte Nummer	Número grabado en la pinza de freno	Numero inciso sulla pinza di freno
	Electrique avec boîtier	Electric with housing	Elektrisch mit Gehäuse	Eléctrico con caja	Elettrico con cambio
	Electrique sans boîtier	Electric without housing	Elektrisch ohne Gehäuse	Eléctrico sin caja	Elettrico senza cambio
	Nbre de cannelures du boîtier	Housing teeth number	Verzahnungszahl des Gehäuses	N° de estrías de la caja	N° di scanalature del cambio



La puissance d'un stock de qualité
Power in stock and quality
Leistungsfähigkeit eines erstklassigen Lagers
La potencia de un stock de calidad
La forza di uno stock di qualità

Service commande / Order Service / Bestellservice / Servicio de orden / Servizio ordini

Corinne MARCHAND	04 75 48 50 50	c.marchand@sorea.biz
FAX	04 75 48 55 00	

Service expédition / Shipping department / Versandservice / Servicio de envío / Servizio di spedizione

Pascal USSEGLIO	04 75 48 55 14	p.usseglio@sorea.biz
-----------------	----------------	----------------------

Service facturation / Billing service / Abrechnungsservice / Servicio de facturación / Servizio di fatturazione

Agnès BERTHOIN	04 75 48 55 23	a.berthoin@sorea.biz
----------------	----------------	----------------------

Service commercial / Commercial service / Kommerzielle Dienstleistung / Servicio comercial / Servizio commerciale

France

Valérie LIGIER	04 75 48 55 27	v.ligier@sorea.biz
Caroline FAURE	04 75 48 55 15	c.faure@sorea.biz

International

Stéphanie MICHAUD	+33 4 75 48 55 04	s.michaud@sorea.biz
Karen GUILLERMOND	+33 4 75 48 55 06	k.guillermond@sorea.biz
FAX	+33 4 75 48 55 00	

Service après vente / After sales service / Kundendienst / Servicio postventa / Servizio post vendita

DELSALLE Jérôme	03 22 90 37 01	mag-etrier@pnti.fr
-----------------	----------------	--------------------